

# Molteni & C

## 505 UP - SYSTEM — NICOLA GALLIZIA 2021

1—  
28



The 505 UP System, a long-time classic in the Molteni&C range of modular systems for the living area, evolves once again to meet the new styles typical of contemporary living. Nicola Gallizia presents a new door enriched with a full-height handle that becomes a profile decorating the layout. The finishes include coffee oak and the exclusive 3D effect, which can be customised in all colours in the Molteni&C range. The 505 UP System moves further away from the classic bookcase, expanding its possibilities and becoming a modern piece of furniture for a contemporary concept of living.

### Harry's Bar Module

The Harry's Bar module was conceived as a fully independent element, but suspended within the 505 system. Two large doors, boxed or glazed and opening a full 180° by means of an invisible hinge, provide access to the interior compartment finished with wood, ceramic, or Eco Skin, designed to neatly accommodate and store utensils and bottles for all types of beverages.

DATASHEET

REGISTERED  
DESIGN

IX.2023

[moltenigroup.com](http://moltenigroup.com)

Dimensions in millimeters and inches. The right to discontinue and make changes is reserved. This information is based on the latest product information available at the time of printing.

**MODULARITY**

**Measurements**

Wall to wall widths:  
320 - 480 - 640 - 960 - 1280 - 1440 - 1920 + 32 mm for end side panel  
12 5/8" - 18 7/8" - 25 1/4" - 37 3/4" - 50 3/8" - 56 3/4" - 75 5/8" + 1 1/4"

Heights:  
465 - 849 - 1233 - 1617 - 2001 - 2385 - 2769 - (2961- 116 5/8" for cutting to length) mm  
18 1/4" - 33 3/8" - 48 1/2" - 63 5/8" - 78 3/4" - 93 7/8" - 109"

Structure depth:  
320 - 400 mm  
12 5/8" - 15 3/4"

**Notes**

A minimum space of 3 cm (1 1/8") in height is required for assembly, and in the case of installation in a compartment, the width is necessary:  
- 4 cm (1 5/8") for floor compositions (2 cm - 3/4" per side)  
- 6 cm (2 3/8") for wall-hung compositions (3 cm - 1 1/8" per side)  
For cuts in the three dimensions (width, height, depth) the reduction is carried out to the millimetre; in all cases the cost of the reduction is borne by the customer.

The module width can be reduced by up to 320 mm - 12 5/8" (centre distance):  
the W 320 - 12 5/8" module cannot be reduced in width.

**No reduction possible for:**  
**Internal and external drawers**  
**Glass hinged doors**  
**Vertical sliding doors**  
**Flap door th 35 (1 3/8")**  
**Modules W 1280 (50 3/8"), 1420 (55 7/8") and 1920 (75 5/8") in depth**  
**Protruding elements DISPLAY D 500 (75 5/8")**

**Heights and depths of the units resting on the floor**

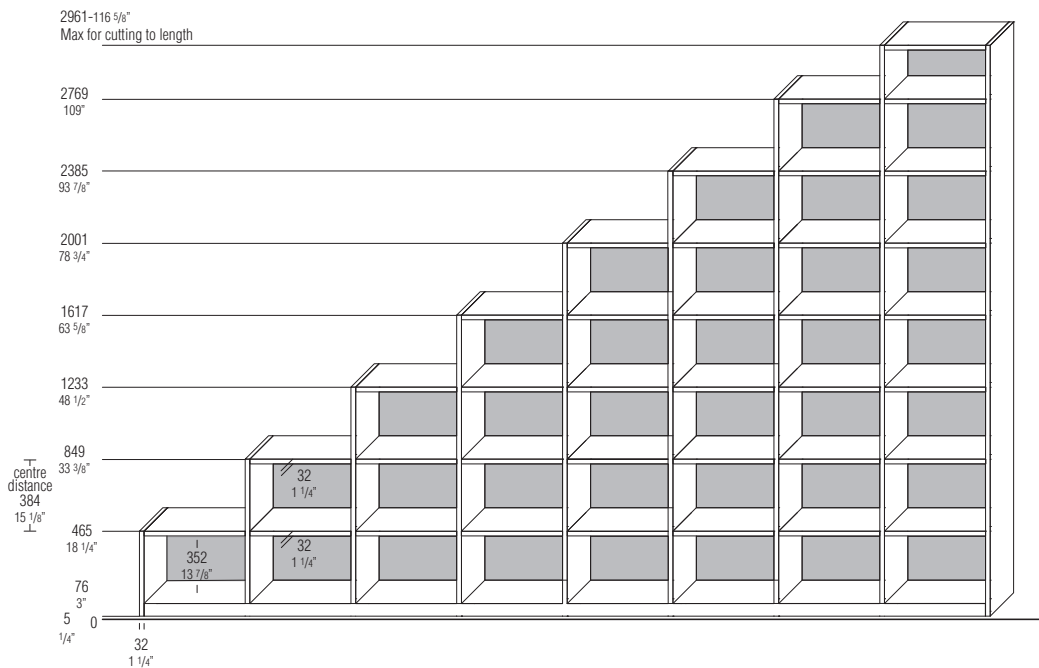

**Modularity of widths**

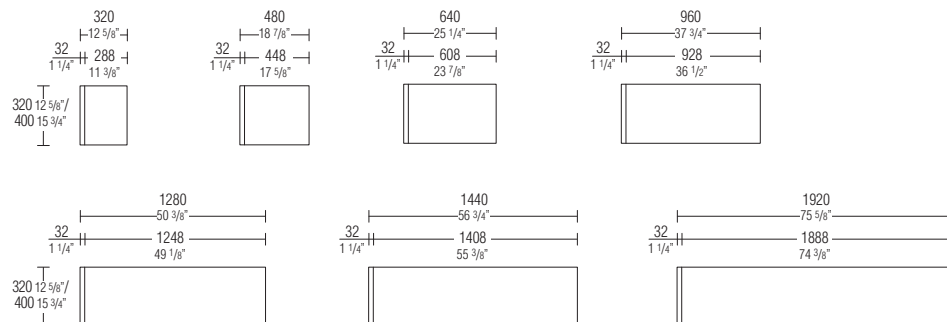

**DATASHEET**

REGISTERED  
DESIGN

IX.2023

## FINISHES

### Wood grain

#### Pressure opening th 35

- HORIZONTAL GRAIN for vertical sliding, drawers and flap doors

#### Pressure opening th 22

- HORIZONTAL GRAIN for drawers  
- VERTICAL GRAIN for hinged doors

### Lines

#### 3D matt lacquer colours

#### Handle opening th 22

- VERTICAL LINES for hinged doors

#### Pressure opening thickness 22

- HORIZONTAL LINES for drawers  
- VERTICAL LINES for hinged doors

# Molteni & C

3—  
28

finishes	matt lacquer colours	glossy lacquer colours	glaze	woods	special woods	3D matt lacquer colours	pewter colour / copper / iris	transparent glass	stopsol transparent glass	net glass	Eco Skin	coloured glass/coloured etched glass	marble	woods rays
<b>components</b>														
32 th. structure and plinth														
back panels														
rear finish panels														
internal drawers														
shelves														
tops														
protruding shelf D 540														
TV back panel														
central dividing profile														
glass panel														
12 thick central dividing panels														
door opening th. 35 (vert. sliding/flap/drawers)														
doors / external drawers with pressure opening th 22														
door frame profile														
glass th. 35										*				
door frame profile														
Eco Skin th. 35														
open DISPLAY / DISPLAY structure														
doors DISPLAY / ext. drawers with press. opening th 22														
door profile														
DISPLAY frame														
glass th 35										*				
door profile														
DISPLAY frame														
Eco Skin th 35														
door with handle th 22/35														

\* for stopsol vertical sliding door (etched glass)

colours	Matt lacquer	Glossy lacquer	Woods structure and front	Special woods	Woods rays	Coloured glass	Coloured etched glass	Eco Skin	Marble
BC chalk white	BC chalk white	BC chalk white	EU eucalyptus	RT thermo oak	REU eucalyptus rays	BC chalk white	BC chalk white	grey	white Carrara
PE pearl	PE pearl	PE pearl	RF graphite oak	RS sunrise oak	RRF graphite oak rays	PE pearl	PE pearl	mink	orient grey
DN dune	DN dune	DN dune	RC coffee oak		RRS sunrise oak rays	DN dune	DN dune	hemp	green alpine
PL platinum	PL platinum	PL platinum			RRT thermo oak rays	PL platinum	PL platinum	ivory	black marquina
NE black	NE black	NE black			RRC coffee oak rays	NE black	NE black	dark brown	calacatta (special price)
AT anthracite	AT anthracite	AT anthracite				AT anthracite	AT anthracite	earth	
SE mustard	SE mustard	SE mustard				SE mustard	SE mustard	arctic	
SI silica	SI silica	SI silica				SI silica	SI silica	taupe	
DO dolomite grey	DO dolomite grey	DO dolomite grey				DO dolomite grey	DO dolomite grey		
AL clay	AL clay	AL clay				AL clay	AL clay		
MK moka	MK moka	MK moka				MK moka	MK moka		
CZ light blue grey	CZ light blue grey	CZ light blue grey				CZ light blue grey	CZ light blue grey		
SA sand	SA sand	SA sand				SA sand	SA sand		
RU ruby	RU ruby	RU ruby				RU ruby	RU ruby		
PX pewter colour	PX pewter colour	PX pewter colour				PX pewter colour	PX pewter colour		
RX copper	RX copper	RX copper				RX copper	RX copper		
TO dove grey	TO dove grey	TO dove grey				TO dove grey	TO dove grey		
PR petroleum blue	PR petroleum blue	PR petroleum blue				PR petroleum blue	PR petroleum blue		
BG burgundy	BG burgundy	BG burgundy				BG burgundy	BG burgundy		
LS london sky	LS london sky	LS london sky				LS london sky	LS london sky		
SU stardust	SU stardust	SU stardust				SU stardust	SU stardust		
ML moonlight	ML moonlight	ML moonlight				ML moonlight	ML moonlight		
SP spice	SP spice	SP spice				SP spice	SP spice		
PG pine green	PG pine green	PG pine green				PG pine green	PG pine green		
AW almond white	AW almond white	AW almond white				AW almond white	AW almond white		

### DATASHEET

REGISTERED  
DESIGN

IX.2023

## HARRY'S BAR MODULE FINISHES

finishes	matt lacquer colours	wood/ special woods	pewter colour / copper / iris	transparent stopsol glass/ stopsol glass etched	Eco Skin grey / dark brown	calacatta vena vecchia ceramic	pewter colour matt lacquer	black oak/ black	coloured etched glass
<b>components</b>									
structure									
back panel									
drawer-tray front									
wine glass rack									
drawer accessories									
drawer top unit									
glass doors	profiles								
	glass								
wooden doors	door								
	internal bottom containers								

### colours

#### Matt lacquer

BC chalk white  
PE pearl  
DN dune  
PL platinum  
NE black  
AT anthracite  
SE mustard  
SI silica  
DO dolomite grey  
AL clay  
MK moka  
CZ light blue grey  
SA sand  
RU ruby  
PX pewter colour  
RX copper  
TO dove grey  
PR petroleum blue  
BG burgundy  
LS london sky  
SU stardust  
ML moonlight  
SP spice  
PG pine green  
AW almond white

#### Wood

EU eucalyptus  
RF graphite oak  
RC coffee oak

#### Special woods

RT thermo oak  
RS sunrise oak

#### Eco Skin

grey  
dark brown

#### Coloured etched glass

BC chalk white  
PE pearl  
DN dune  
PL platinum  
NE black  
AT anthracite  
SE mustard  
SI silica  
DO dolomite grey  
AL clay  
MK moka  
CZ light blue grey  
SA sand  
RU ruby  
PX pewter colour  
RX copper  
TO dove grey  
PR petroleum blue  
BG burgundy  
LS london sky  
SU stardust  
ML moonlight  
SP spice  
PG pine green  
AW almond white

Molteni & C

THROUGH COMPARTMENTS

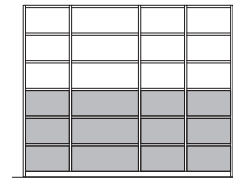
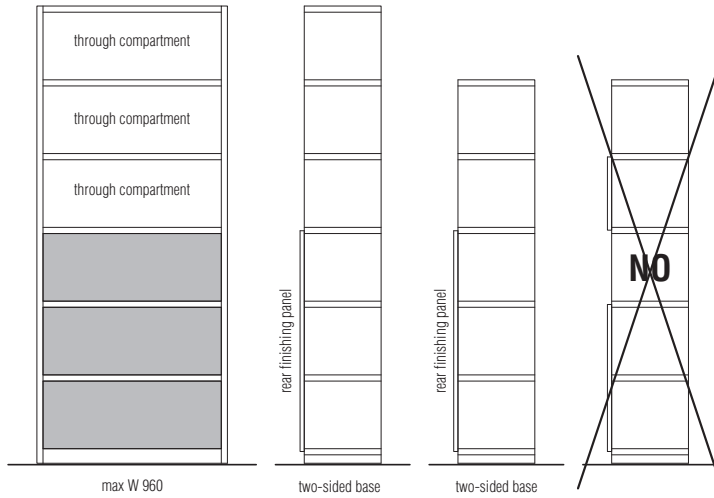

Two-sided compositions (centre of room) with through compartments

- Through compartment available for modules with max W 960.
- Rear finishing panels starting from the base covering 50% of the structure in height; in the event of an odd number of compartments, 50% plus one compartment.
- It is not possible to fit DISPLAY in through compartments.
- It is not possible to install lights because all the work for the cable routing would be visible on one side.
- Central dividing panels cannot be inserted in through compartments, as the joints would be visible.
- For the W 960 compartment, a reinforced shelf can be fitted at the customer's discretion.

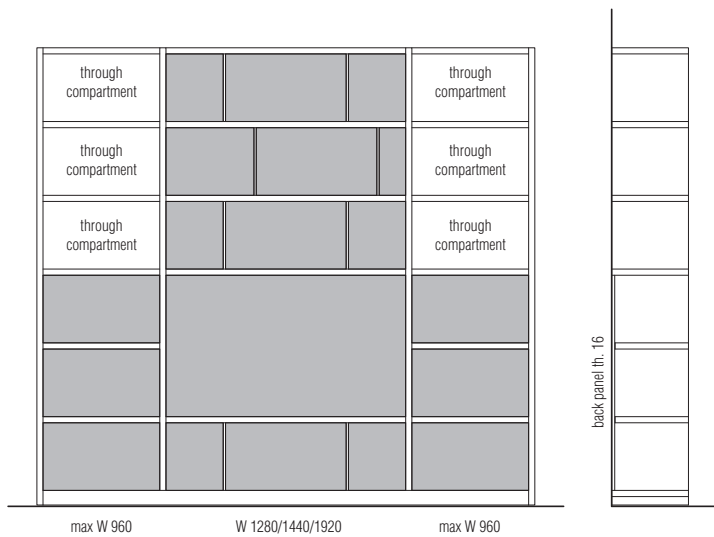

Wall compositions with through compartments

- Through compartment available for modules with max W 960.
- Th. 16 back starting from the base covering 50% of the structure in height; in the event of an odd number of compartments, 50% plus one compartment.
- It is not possible to fit DISPLAY in through compartments.
- It is possible to include lights, but it is the responsibility of the installer to conceal the cable passage in compartments that do not have backs.
- Central dividing panels can be inserted in the through compartments.
- For the W 960 compartment, a reinforced shelf can be fitted at the customer's discretion.

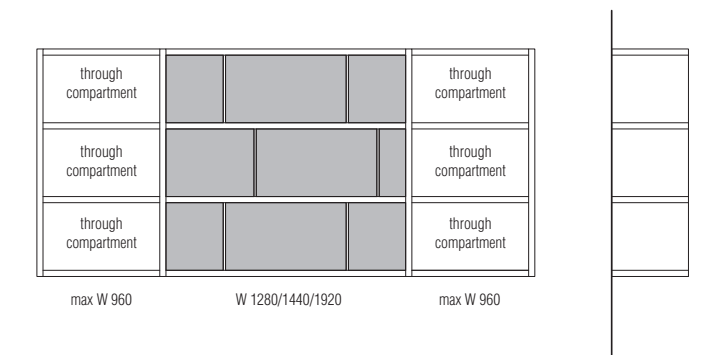

Hanging compositions with through compartments

- Through compartment available for modules with max W 960.
- It is not possible to fit DISPLAY in through compartments.
- It is possible to include lights, but it is the responsibility of the installer to conceal the cable passage in compartments that do not have backs.
- Central dividing panels can be inserted in the through compartments.
- For the W 960 compartment, a reinforced shelf can be fitted at the Customer's discretion.

DATASHEET

REGISTERED  
DESIGN

IX.2023

**Compositions with pressure opening wooden doors**

from the ground - max 4 modules

hanging - max 4 modules

stacked

**Compositions with wooden doors with handle**  
from the ground - 5/6/7 modules

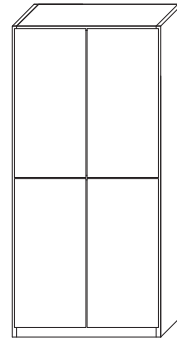
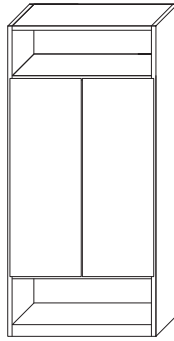
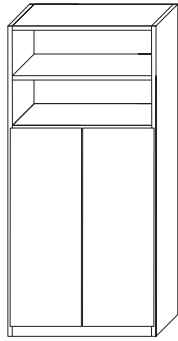

max  
4 modules

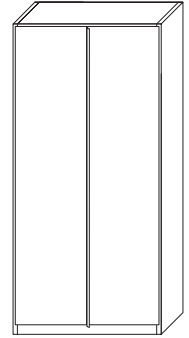

**Compositions with glass doors**

from the ground - max 6 modules

hanging - max 5 modules

stacked - max 3 modules

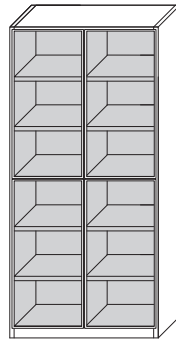
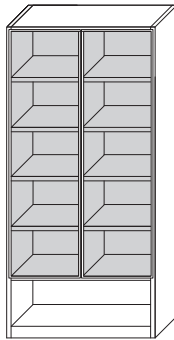
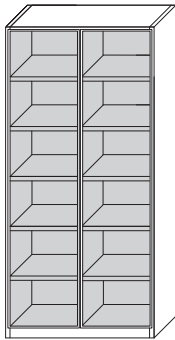

**Compartments division W 960 for partial closure with door**

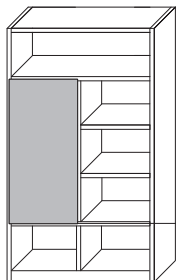

In the case of installing a central dividing panel H 2 and H 3 modules it is also necessary to insert the central dividing panels in the compartments below

With the presence of a drawer in the lower part, provide a reinforced top in W 928

## MODULE CONSTRUCTION UP TO W 960 (37 3/4")

Modules must always have full or divided backs 16 th.  
Double-sided compositions can be made with back panels. **The presence of back panels or rear finish panels is essential for the stability of the compositions.**  
Any requests for modules with opening compartments must be examined by the Molteni Technical Office as they could compromise the stability of the composition.

**Key to symbols**  
PS - structural shelves  
RG - open shelves  
RI - internal shelves  
BA - base  
Z - plinth

Molteni & C

7—  
28

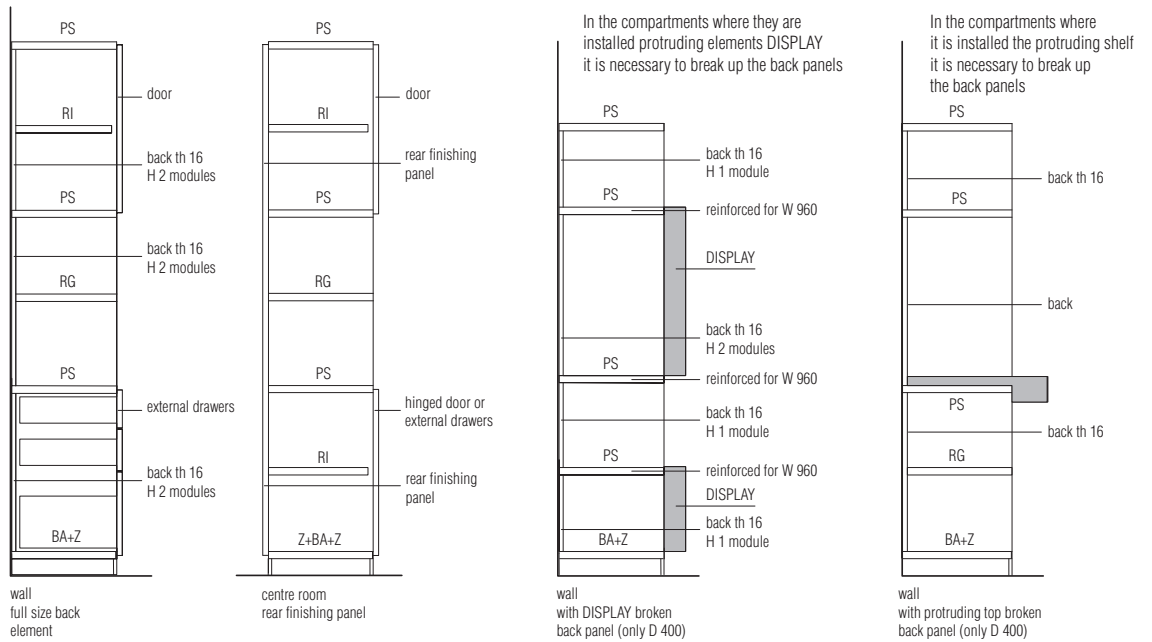

### DISPLAY positioning

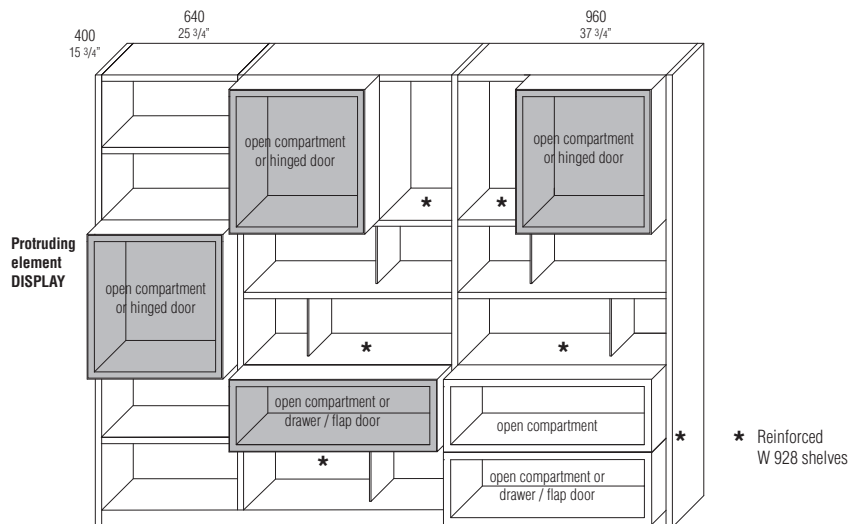

The protruding DISPLAY element can be installed in the same size compartment or in a larger compartment.

The positioning inside the compartment must always respect the 160 mm pitch because it is fixed to the structure D 400.

A central dividing panel or another DISPLAY must always be inserted in the compartments below the protruding DISPLAY element, with the exception of the W 640 module.

In W 960 compartments, the structural shelf below and/or above the DISPLAY must be reinforced.

Only an open DISPLAY can be placed above and below the protruding DISPLAY with flap door.

### DATASHEET

REGISTERED  
DESIGN

IX.2023

## MODULES CONSTRUCTION 1280-1440-1920 (50 3/8" - 56 3/4" - 75 5/8")

For the construction of these modules, it is mandatory to have in each compartment:

- 16 mm th back panel (always in module width)
- one or more central dividing panels (wood, 32 mm th - glass, 10 mm th or rounded, 12 mm th) positioned at 160 mm intervals at a maximum distance of 960 mm for 1280/1440 mm wide compartments
- two or more central dividing panels positioned at 160 mm intervals at a maximum distance of 960 mm for W 1920 compartments.

This construction does not require reinforced structural shelves except in cases of installation of the DISPLAY or in other situations indicated in the specific paragraphs.

In the open area, it is possible to make compartments 64 mm higher or lower than the standard module (mm 352).  
For this purpose, 416 mm and 288 mm centre dividers and back panels are available.  
Within a column, the 416 mm and 288 mm recesses must always offset each other.

# Molteni & C

8—  
28

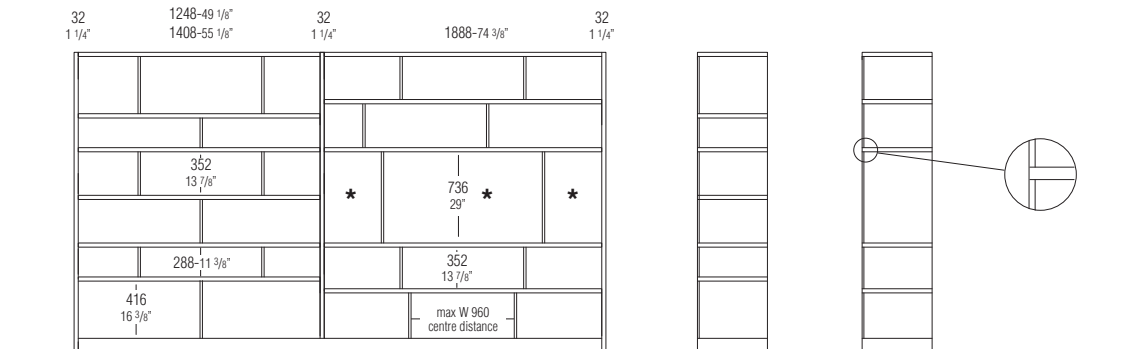

At least two dividing panels per compartment at a maximum distance of mm 960

\* The indicated compartments can be closed with wooden or glass doors using 32 mm th. wooden central partition walls

The maximum height of the wooden panels are 1120 mm (H 3 modules)

### Modules W 1280-1440-1920 (50 3/8" - 56 3/4" - 75 5/8") with doors

#### Compositions with doors

W 1920-75 5/8"  
from the ground - max 3 modules

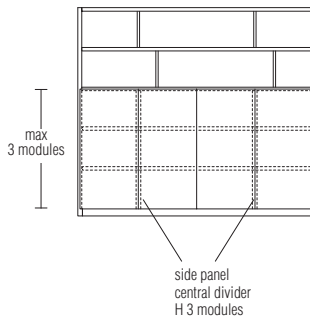

W 1920-75 5/8"  
suspended doors

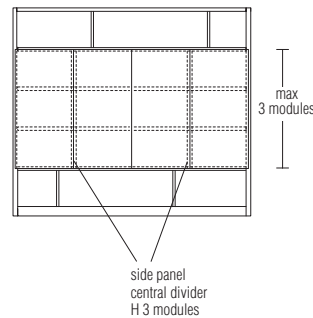

W 1280-50 3/8"  
from the ground

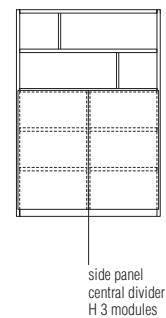

W 1440-56 3/4"  
suspended doors

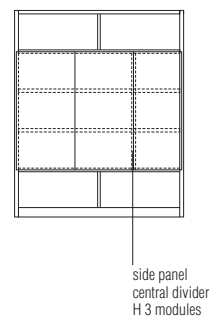

#### DATASHEET

REGISTERED  
DESIGN

IX.2023



**MODULES CONSTRUCTION 1440 - 1920 (56 3/4" - 75 5/8")**

Molteni & C

**Example 1**

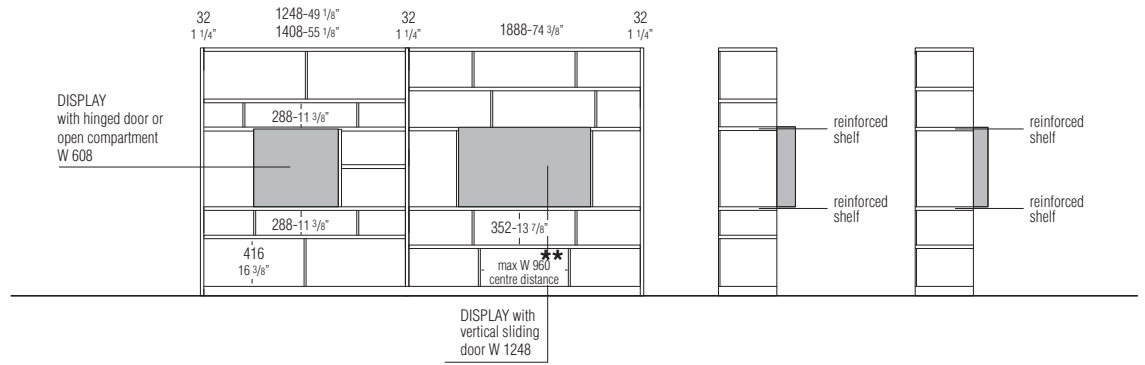

**Example 2**

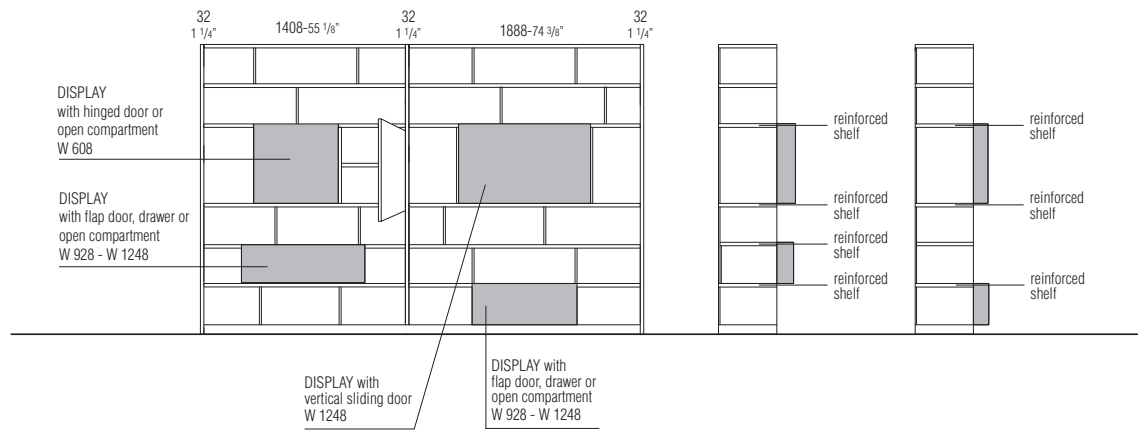

The protruding DISPLAY elements can be freely inserted into compartments without central dividing panels, but with the use of reinforced shelves. The positioning must always respect the 160 mm pitch because it is fixed to the structure.

If you want to close the adjacent side compartment or install a shelf, you need to use the 32 mm th. wooden central dividing panel (see examples).

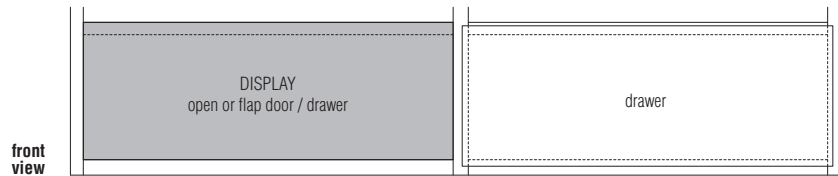

**DATASHEET**

REGISTERED  
DESIGN

IX.2023

**MODULES CONSTRUCTION 1280-1440-1920 (50 3/8" - 56 3/4" - 75 5/8")**

W 1280-1440-1920 compartments can be used for the installation of glass doors with glass side panels.  
In this case, the shelves are full size flush with the panels and the central glass dividers are always H 1 module.

Molteni & C

10 -  
28

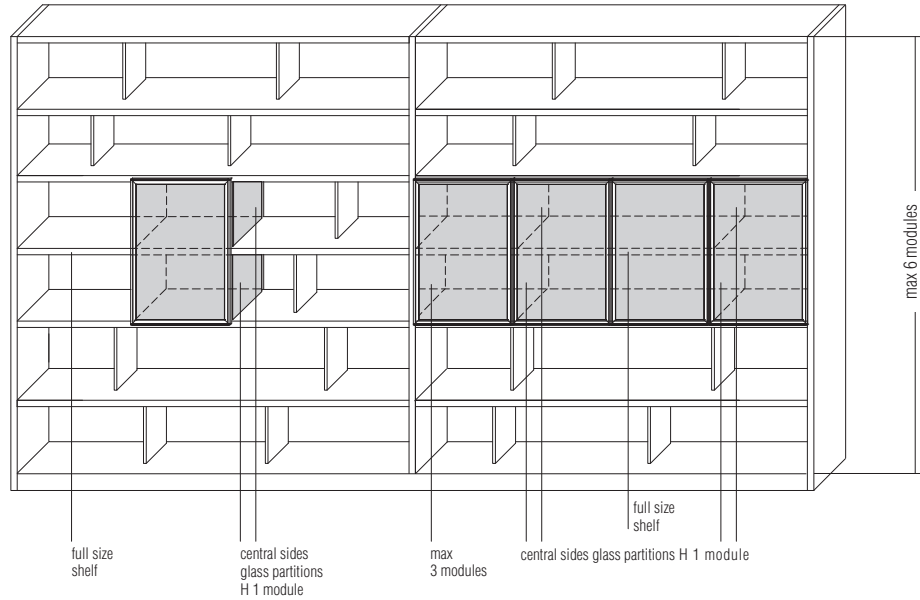

**side section**

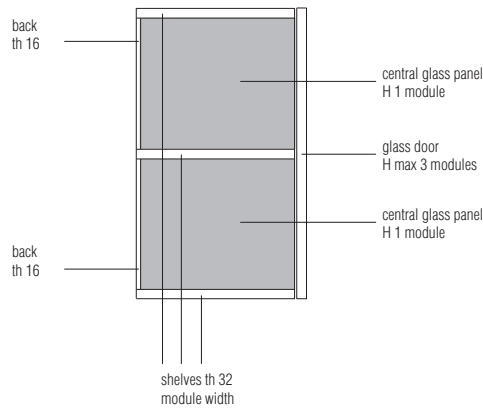

**DATASHEET**

REGISTERED  
DESIGN

IX.2023

## POINTS OF ATTENTION WITH MODULAR COMPONENTS

Molteni & C

11 –  
28

### Compartments with multiple boiserie panels D 400

The presence of a compartment above and below the boiserie compartment with double panels is mandatory. In addition, the width of the upper and lower shelves **A** must correspond to the width of the panel

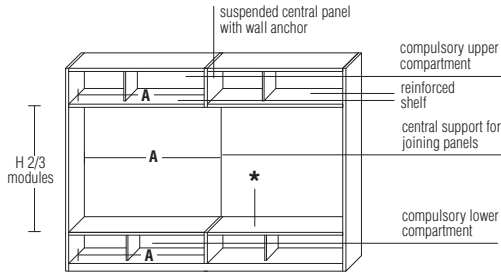

\* The lower part of the boiserie compartment must always be finished with a wooden top th. 10 or a protruding shelf D 540 H 72

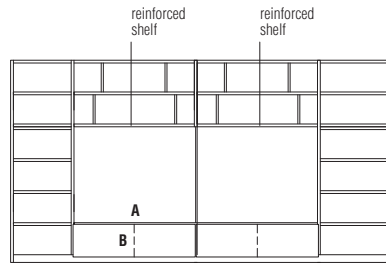

- A** - The 10 th. wooden top is always of the same size as the wall panelling compartment
- B** - The compartment can be closed with a flap door or drawers following the construction rules

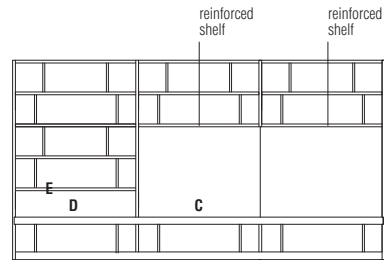

- C** - The protruding shelf can be extended on more compartments in the composition
- D** - The compartment above the protruding shelf cannot accommodate panels of th. 32
- E** - For compartments W 1280-1440-1920 always use a reinforced shelf

### Structure for Harry's Bar

Harry's must always be incorporated:

- in columns D 400
- in columns W module 1280
- between two side panels
- starting from the second module (H 465)

The compartment where Harry's fits is without a back panel because the price of the back panel is already included in the bar module.

The structural shelves below and above Harry's bar module must be reinforced. The 505 UP - System compositions with Harry's bar module are wall mounted.

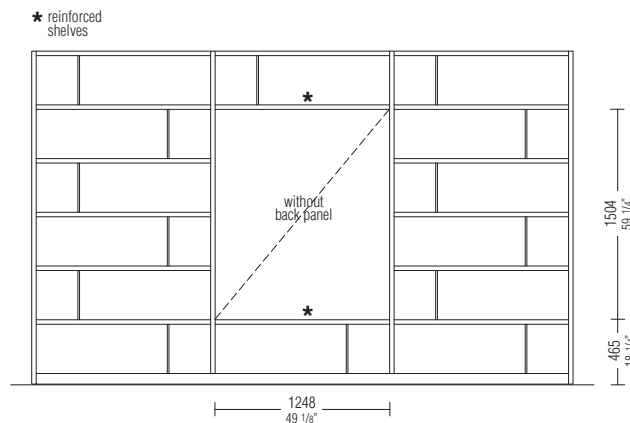

Harry's bar fitted at the side requires a minimum space of 640 mm for door opening. Two Harry's bar can be arranged in the same composition by inserting an W 640 compartment between the two

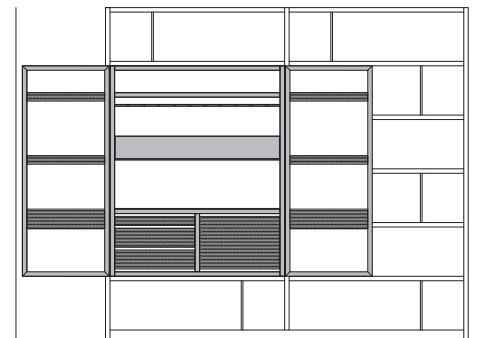

Internal drawers can only be opened after the door has been fully rotated to 180°

### DATASHEET

REGISTERED  
DESIGN

IX.2023

## HOLE DIAGRAM FOR SIDES

Drilling of panels for shelf positioning is available in these modes to be specified when ordering:

A - Holes in shelves only

B - 3-hole set (64 mm centre distance) distance 384 mm

C - Regular interval 64 mm - with surcharge

**If there are no specific indications, type B drilling will be carried out - group 3 holes.**

The individual columns of a composition can have different perforations.

Within the column the type of drilling cannot vary.

### Notes

Wall mounted panels have no holes for shelves in the upper part for mm 400 (see design).  
Central dividing panels H 1 module are always unperforated.

In the open parts, it is possible to make compartments 64 mm higher or lower than the standard module (384 mm).

For this purpose, 416 mm and 288 mm centre dividers and back panels are available.

# Molteni & C

12 -  
28

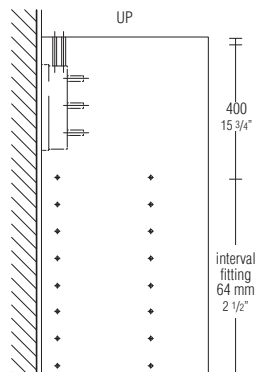
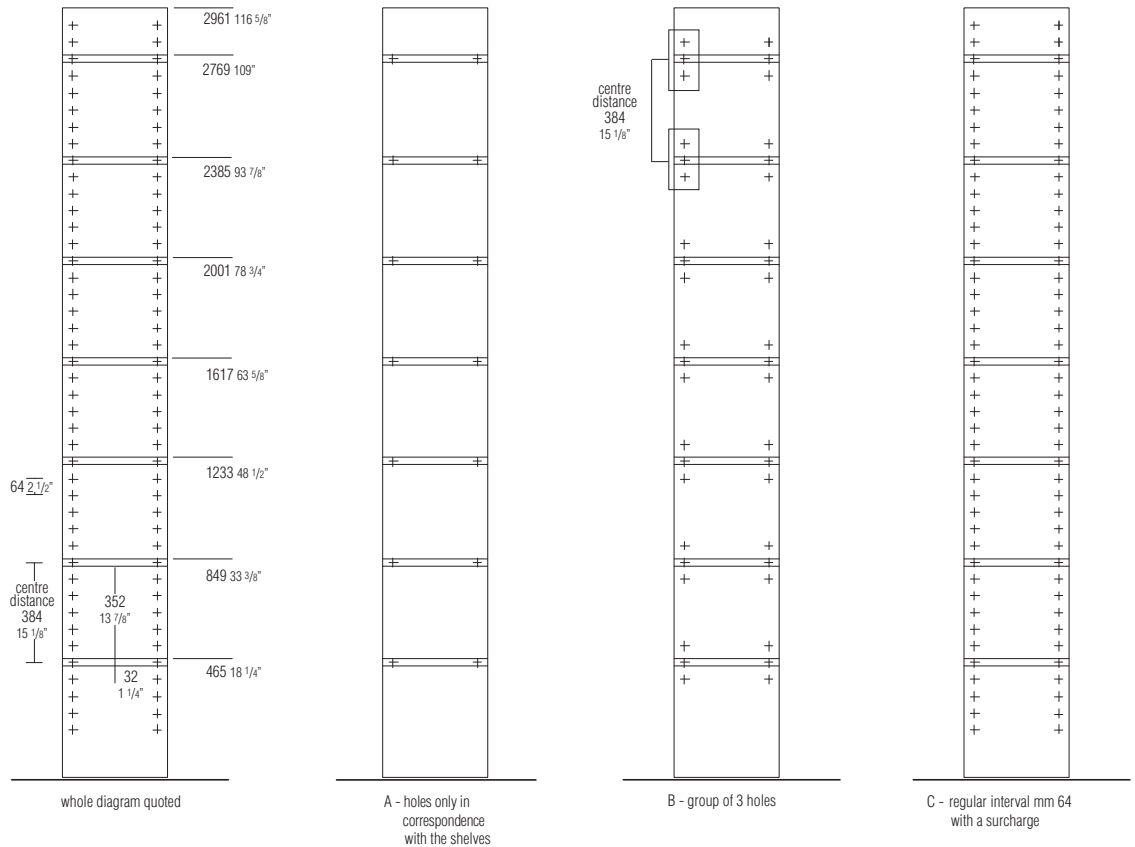

### DATASHEET

REGISTERED  
DESIGN

IX.2023

## CHANGE OF DEPTH

When the module of the smaller depth is open, the change of depth is made by directly attaching the components of this module to the adjacent panel of the larger depth (**example 1**).

When the module of the smallest depth is closed with doors or drawers, the change of depth is achieved by combining two compositions of different depths (**example 2**).

**Finishing tops in glass and marble cannot be used in situations where there is a change in depth.**

**Any top on composition with change of depth will always be supplied in two parts.**

## CHANGE OF HEIGHT

**With the change in height, the top is used as in the drawing below.**

Molteni & C

13—  
28

**Change of depth single composition**  
(example 1)

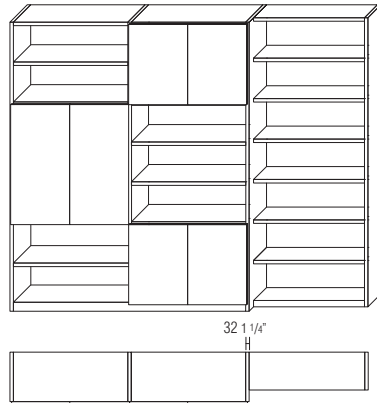

**Change of depth 2 compositions**  
(example 2)

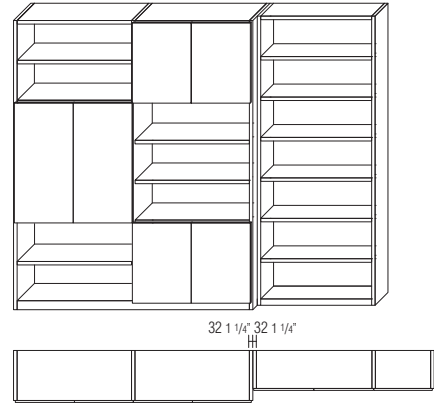

**Change of height single composition**

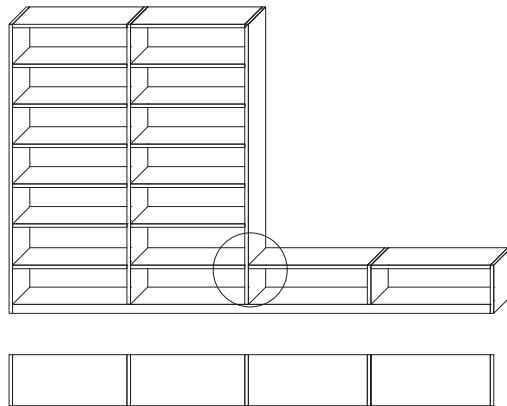

**front**

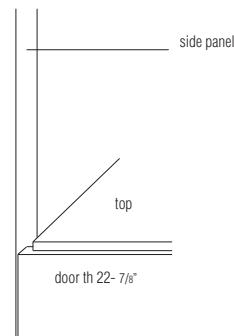

**plan**

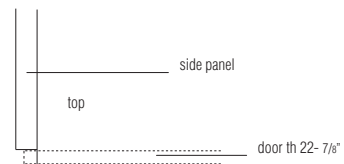

### DATASHEET

REGISTERED  
DESIGN

IX.2023

## INTERNAL DRAWER UNITS

### For open compartments, hinged glass doors and 22 mm th. hinged wood pressure opening doors

The drawer units can be inserted between two standard 32 mm thick shelves (example **A**).

**The drawers are always pressure-opening and always fully extractable.**

The drawers are flush with the structure for open compartments while they are set back by 18 mm (in alignment with internal shelves) when installed in hinged glass doors.

\* woods  
eucalyptus, graphite oak

# Molteni & C

### Example A

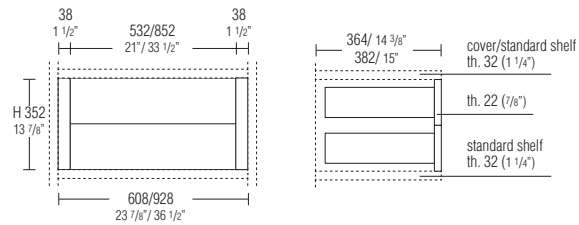

## BOISERIE COMPARTMENTS WITH MULTIPLE PANELS D 400

By using modules 1280-1440-1920 it is possible to create boiserie compartments with two or three back panels up to W mm 5728.

The boiserie compartment always has two or three removable backs on which the TV can be mounted.

If there is a TV mounted, the client is responsible for paying for the wire hole on the back. The back is fixed on its front. The extension must include the use of the bar even if it is mounted on the wall or the composition is suspended. The backs are hooked in the centre thanks to the central panel connecting support.

The structural shelf above the boiserie compartment is always reinforced.

For sizes greater than 3808 mm, the support bar will be made in two pieces.

The height of the back panel is lower than the height of the compartment to allow the routing of cables from the cavity to the TV compartment (see details A and B).

**TV signal receiver** The  $\varnothing$  18 sensor is always positioned in the lower part of the TV back. Specify right or left when ordering. IR bars can only be placed in a compartment adjacent and/or below the TV back (to be specified when ordering). The cost of a wire passage is not included. The bar can only be fixed to the structural shelves.

### Wire passage

The Hi-Fi compartment may be connected using a wire passage to adjacent or lower compartments. The wire passage is located behind the TV back.

### Reductions

Reductions in width only possible with a back panel surcharge.

Molteni & C

15 –  
28

### Compartments with multiple boiserie panels D 400

The presence of a compartment above and below the panel compartment with double panels is mandatory.

In addition, the width of the upper and lower shelves **A** must correspond to the width of the panel

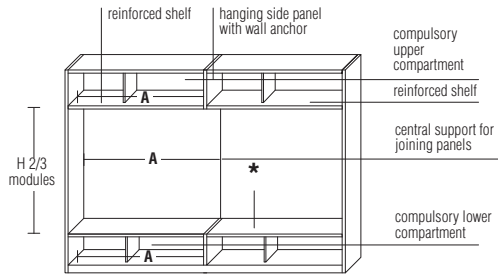

Panels can only be reduced in width.  
Consider surcharge.

\* The lower part of the boiserie compartment must always be finished with a wooden top thickness 10 or a protruding shelf D 540 H 72

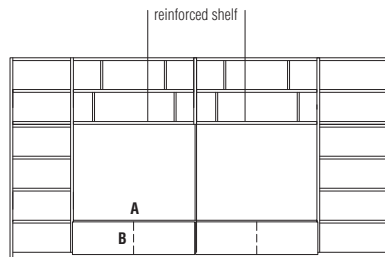

- A** - The 10 th. wooden top is always of the same size as the boiserie compartment
- B** - The compartment can be closed with a flap door or drawers following the construction rules

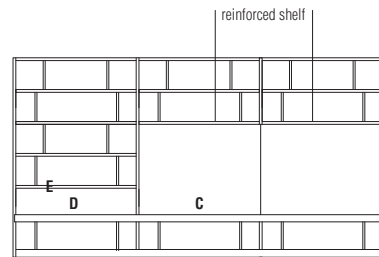

- C** - The protruding shelf can be extended on more compartments in the composition
- D** - The compartment above the protruding top cannot accommodate panels of th. 32
- E** - For compartments W 1280-1440-1920 always use a reinforced shelf

### DATASHEET

REGISTERED  
DESIGN

IX.2023

## TV COMPARTMENTS D 400 (SINGLE PANEL)

Using the module widths 1280-1440-1920, it is possible to create TV compartments.  
The TV compartment is always equipped with a removable backrest on which the TV can be hung. If there is a TV mounted, the client is responsible for paying for the wire hole on the back.  
The back is fixed on its front. The extension must include the use of the bar even if it is mounted on the wall or the composition is suspended.

The structural shelf above the TV compartment is always reinforced.

The height of the TV back panel is lower than the height of the compartment to allow the passage of cables from the cavity to the TV compartment (see details A and B).

### TV signal receiver

The ø 18 sensor is always positioned in the lower part of the TV back.  
Specify right or left when ordering. IR bars can only be placed in a compartment adjacent or below the TV back (to be specified when ordering). The cost of a wire passage is not included. The bar can only be fixed to the structural panels.

### Wire passage

The Hi-Fi compartment may be connected using a wire passage to adjacent or lower compartments. The wire passage is located behind the TV back.

### Reductions

Reductions are only possible for open TV compartments at a surcharge for cutting the back panel (min. reduction H 2 modules) and for bar.

Molteni & C

16 –  
28

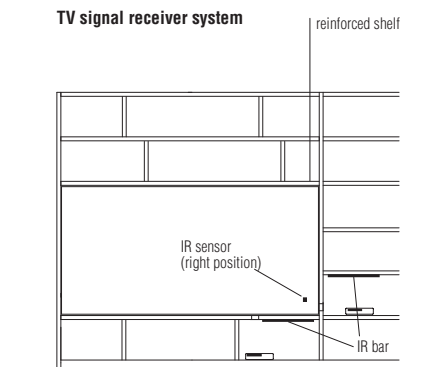
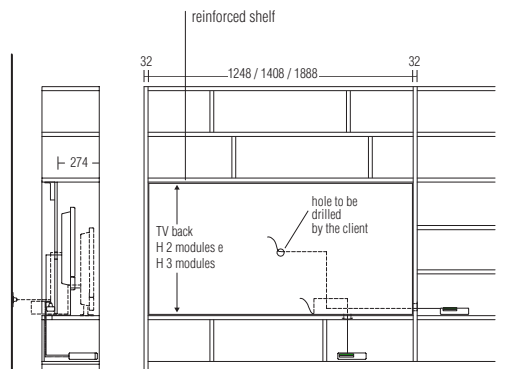

### example of TV compartment W 1888

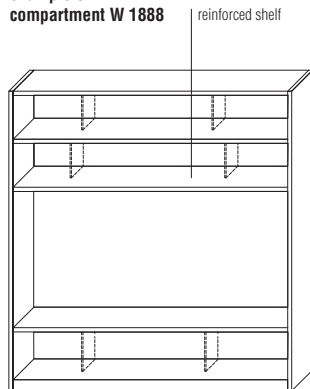

### Boiserie panels / backs for TV th 16 - Wood rays

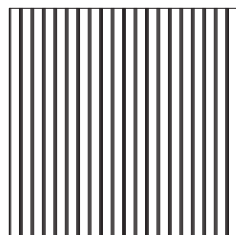

#### Finishes

eucalyptus rays (striped)  
coffee oak rays (striped)  
graphite oak rays (striped)  
sunrise oak rays (striped)  
thermo oak rays (striped)

The panel striping is always in a black finish



#### DATASHEET

REGISTERED  
DESIGN

IX.2023



EXAMPLES OF TV COMPARTMENT W 1280/1440/1920

Molteni & C

17 -  
28

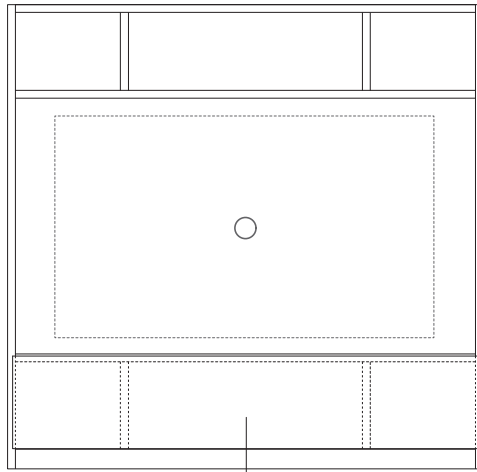

flap door (section 1)

section 1

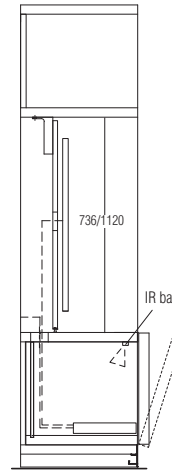

D 400

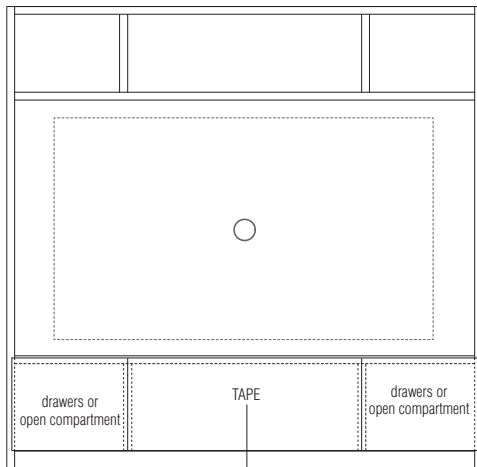

TAPE (section 2)

section 2

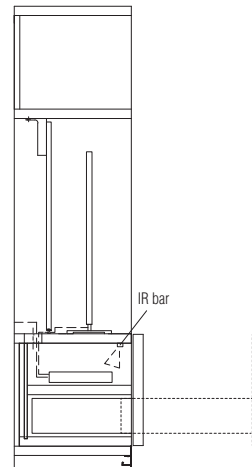

D 400

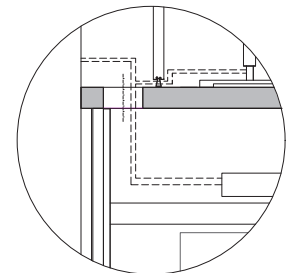

detail A - with resting TV

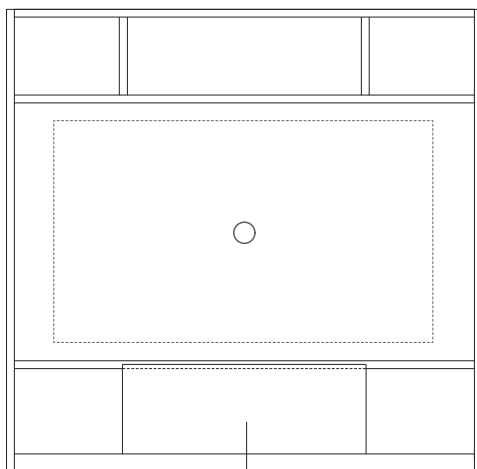

DISPLAY D 500  
with flap door (section 3)

section 3

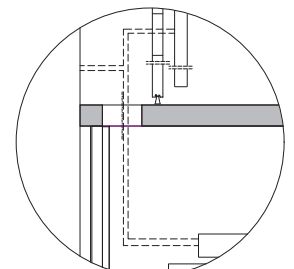
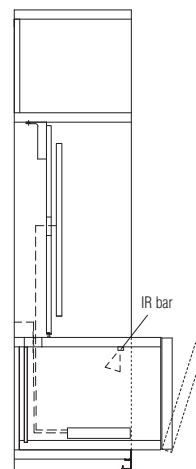

detail B - example with suspended TV

DATASHEET

REGISTERED  
DESIGN

IX.2023

## EXTRA-LARGE TV COMPARTMENT

For up to 85" televisions, the TV compartment shown on this page can be created using two **SHB12/16** panels and a **PGB16** central support bar. In the case of a supported television, use the projecting top, as per the section displayed.

Molteni & C

18 -  
28

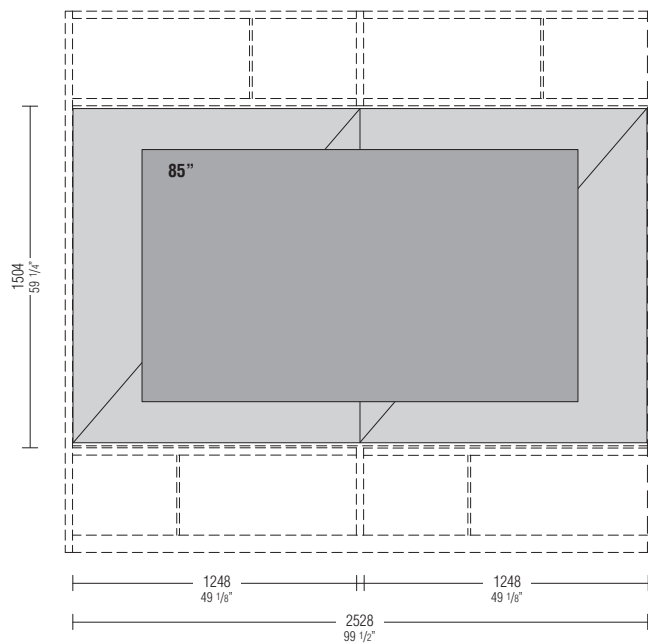

Supported  
TV

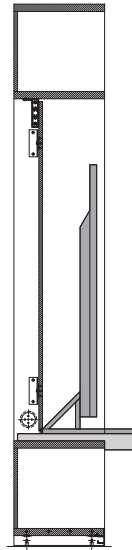

Hanging  
TV

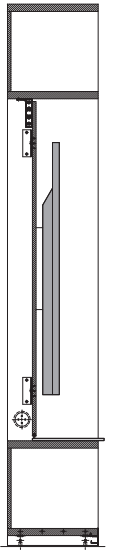

For wall-mounted TVs, it is inadvisable to fasten mobile arms to panels

**TV panel th 16**  
H 1504 (4 modules)

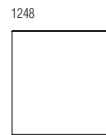

**SHB12/16**

wire passage



**EPA1**

central support for joining panels



H 4 modules  
**PGB16**

DATASHEET

REGISTERED  
DESIGN

IX.2023

## VERTICAL SLIDING DOORS AND FLAP DOORS TH. 35

The compartments of the compositions 505 UP W 1280-1440 can be closed with vertical sliding doors always in H 2 modules. The lower and upper shelves must be reinforced structural shelves with interruption of the back panel. The vertical sliding door cannot be used in the D 320. For the opening of the vertical sliding door the two upper compartments must be open. The vertical sliding mechanism is fully contained in the 2-module H compartment, or 3-module H compartment if in combination with the flap door. Two vertical sliding doors can be placed side by side. The vertical sliding door can be closed on a protruding shelf D 540 H 72.

### Notes

The price of the vertical sliding door includes the rails attached to the panels. On request, without extra charge, the vertical sliding door can be fitted with a type "B" handle centrally located at the bottom.

### "B" type handle

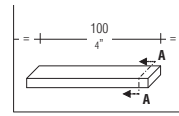

### section A-A

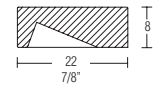

### Reductions

No reductions possible

\* wood only with horizontal grain

# Molteni & C

19 -  
28

### Reinforced shelves

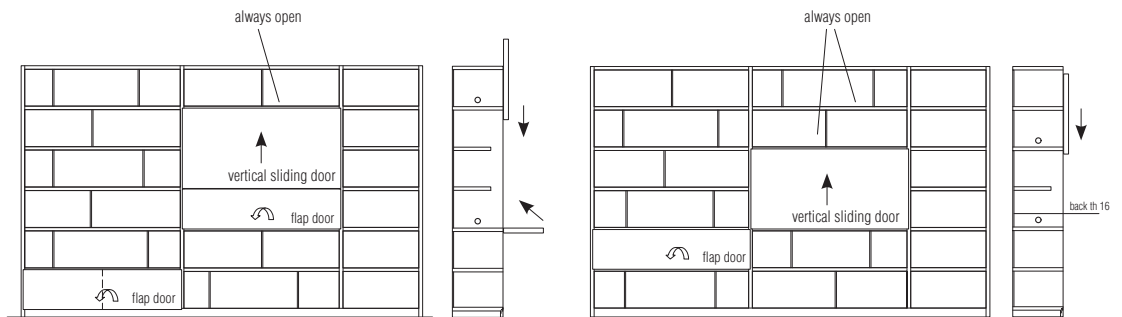

### Deluxe Interior (to insert into compartment with standard back panels)

Version with vertical sliding door + flap door accessorised with:

- 2 bronze mirrors
- Shelf covered in Eco Skin in the colours of the Molteni Range with electrical outlet and USB charger
- Lighting system with 3 LED lights with switch

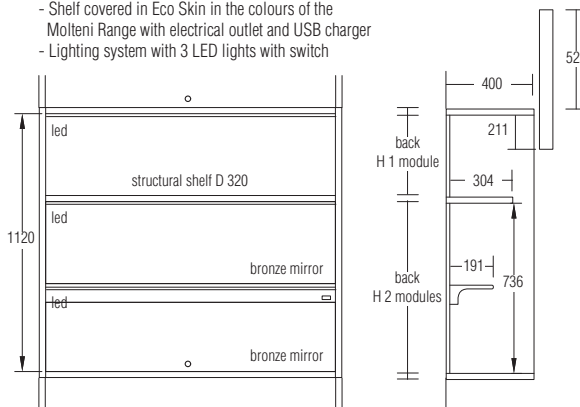

Version with vertical sliding door accessorised with:

- 2 bronze mirrors
- Shelf covered in Eco Skin in the colours of the Molteni Range with electrical outlet and USB charger
- Lighting system with 2 LED lights with switch

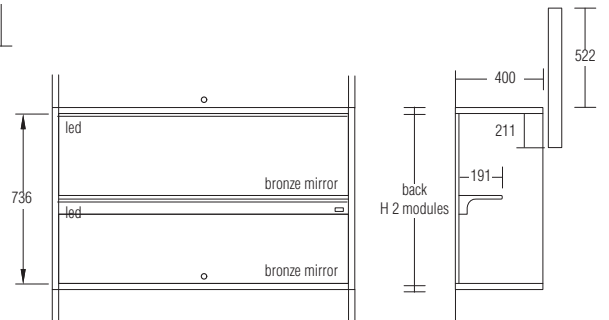

### Standard interior

Version with vertical sliding door + flap door

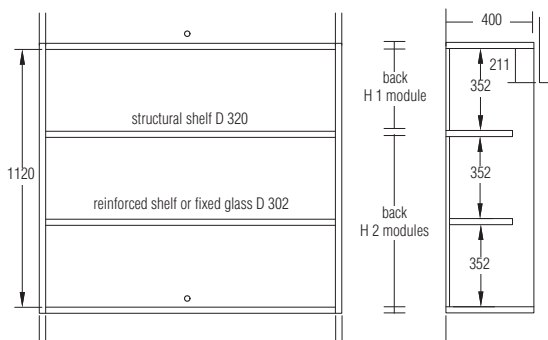

Version with vertical sliding door

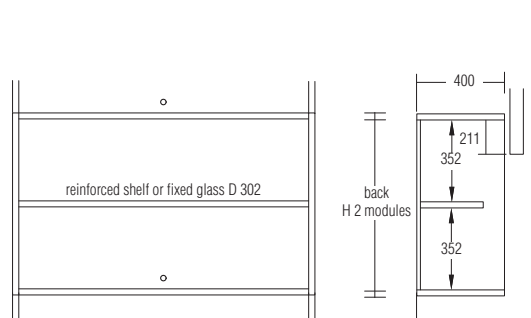

### DATASHEET

REGISTERED  
DESIGN

IX.2023

## PROTRUDING SHELVES D 540 H 72 / H 87 FROM THE FLOOR

Protruding tops can only be used in D 400 compositions.

In floor standing compositions the protruding top can be positioned at a height of 1 or 2 modules, in wall-hung compositions also on the base.

The protruding shelves can be used as a one-sided floor-resting base.

Protruding shelves are placed on the 32 mm structural shelves with the requirement to cut off the back panel, or on the special brackets for wall mounting (**drawing 1**).

The compartment above the protruding shelf must always have a back panel, TV panels or boiserie panels; it can only be closed with a vertical sliding door.

The compartment underneath the protruding shelf is always open.

It is possible to make protruding shelves in one piece up to 2868 mm (two modules of 1440). For longer protruding shelves, the joint is always made at a joint (see detail below **drawing 5**).

The shelf above the protruding board in widths 1280, 1440 and 1920 must always be a reinforced structural shelf.

If used as a floor-resting unit of height higher than 2868 mm, make sure two finished elements are placed adjacent to it.

The shelves can be reduced in width when they are free-standing (**drawing 4**) or for the external part of the composition (**drawing 3**). Cutting to size is included in the price.

The fixing of the wall brackets is the responsibility of the customer and must be carried out in a workmanlike manner, on masonry walls suitable to support the weight and load of the top.

The price of the fixing brackets is not included in the price of the protruding shelf.

The quantity of brackets to be used for free-standing shelves or shelves outside the composition is indicated in the price list according to the corresponding size.

The **EPA3** wire passage can always be applied in a central position with respect to the lower compartment; in the case of a shelf outside the composition, it is expected to be centred with respect to the projecting measurement. Not suitable for floor-resting base units. In the case of Eco Skin shelf, the wire passage will be supplied matt lacquered in a corresponding colour.

### Shelf wood finishes

eucalyptus  
coffee oak  
graphite oak  
thermo oak  
sunrise oak

### Shelf Eco Skin finishes

grey  
mink  
hemp  
ivory  
dark brown  
earth  
arctic  
taupe

### Shelf edging finishes

matt lacquer colours in the Molteni colour range  
pewter colour painted  
copper painted  
iris painted

Drawing 1 - Construction diagram

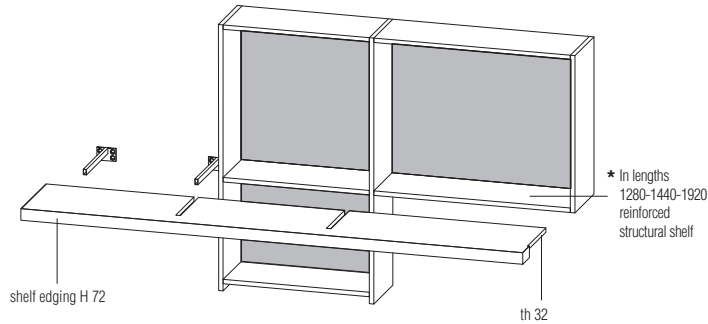

Drawing 6

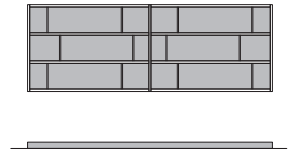

Drawing 2

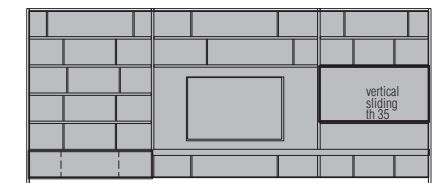

Drawing 3

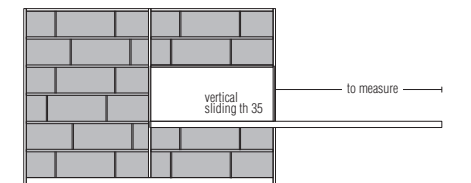

Drawing 4

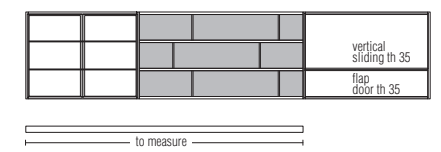

Drawing 5

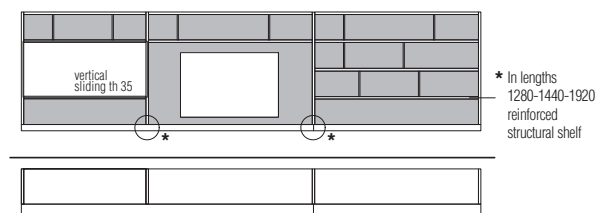

### DATASHEET

REGISTERED  
DESIGN

IX.2023

## PROTRUDING ELEMENTS DISPLAY D 500

DISPLAY protruding elements can only be inserted in D 400 modules.  
Only an open DISPLAY can be placed above and below the DISPLAY with flap door.  
Protruding DISPLAY elements are not reducible.

**Warning:**  
the installation of the DISPLAY in the W 960/1280/1440/1920 modules always requires the use of reinforced structural shelves.

Molteni & C

21 -  
28

### Open DISPLAY D 500

W 928 H 384

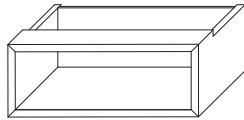

W 1248 H 384

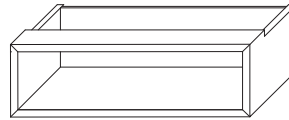

W 608 H 768

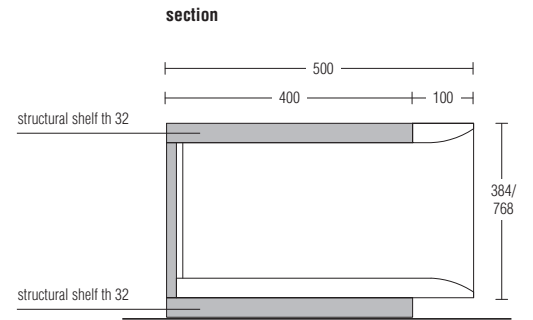
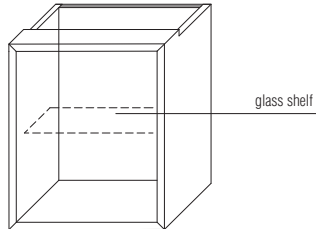

### DISPLAY with doors and drawers D 522 / 535

W 928 H 384

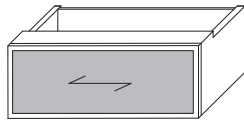

Flap door and drawer  
th 22 or 35

W 1248 H 384



Flap door and drawer  
th 22 or 35

W 608 H 768

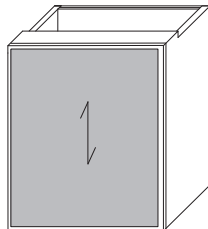

Hinged door  
th 22 or 35

W 1248 H 768

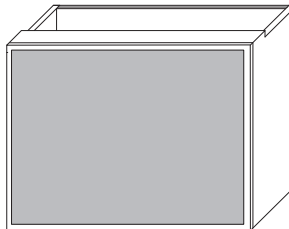

Vertical sliding door  
th 35

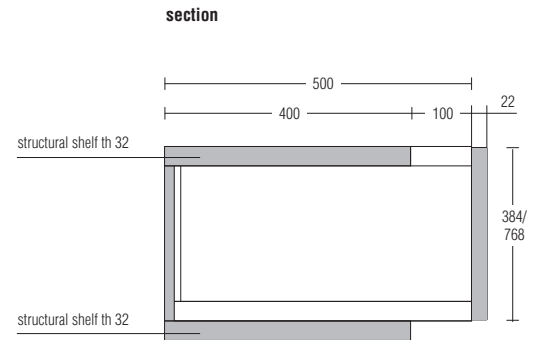

#### DATASHEET

REGISTERED  
DESIGN

IX.2023

## HARRY'S BAR MODULE

Harry's bar module is available in two versions:  
- with glass doors (transparent stopsol glass or stopsol glass etched)  
- with wooden doors

Both options are fitted with 180° hinged doors that open independently of the presence of DISPLAY in adjacent columns.

Harry's is always equipped with internal LEDs (see internal diagram section) with a controlled socket system. For remote control kit (optional) see price list on page 68.

**There can be no reductions of any kind and changes to the planned components.**

### Notes (see drawing 1)

Harry's must always be incorporated:

- in columns D 400
- in columns W module 1280
- between two side panels
- starting from the second module (H 465)

The compartment where Harry's fits is without a back panel because the price of the back panel is already included in the bar module.

The structural shelves below and above Harry's bar module must be reinforced.

The 505 UP - System compositions with Harry's bar module are wall mounted.

Molteni & C

Drawing 1

22 -  
28

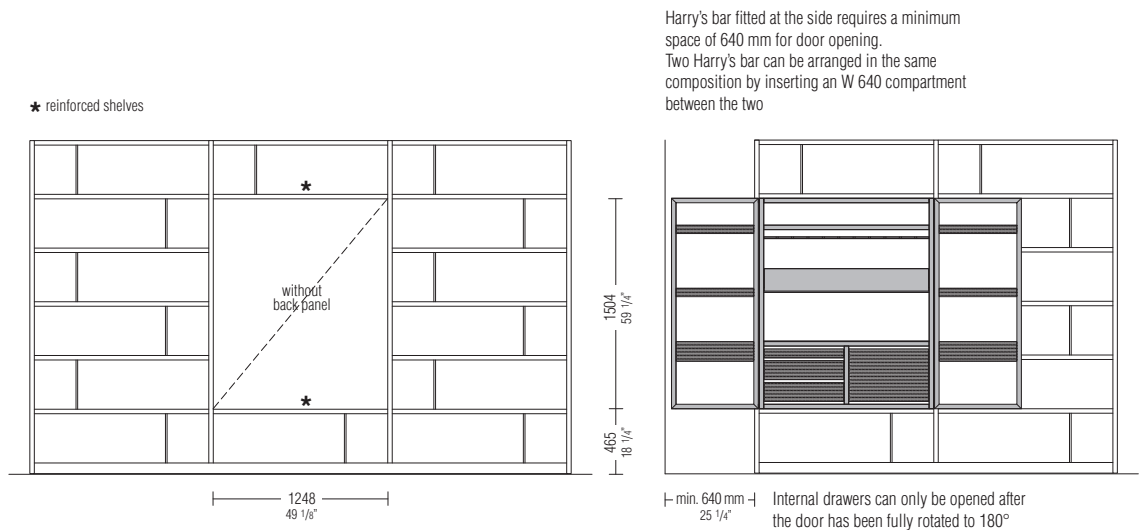

Internal diagram

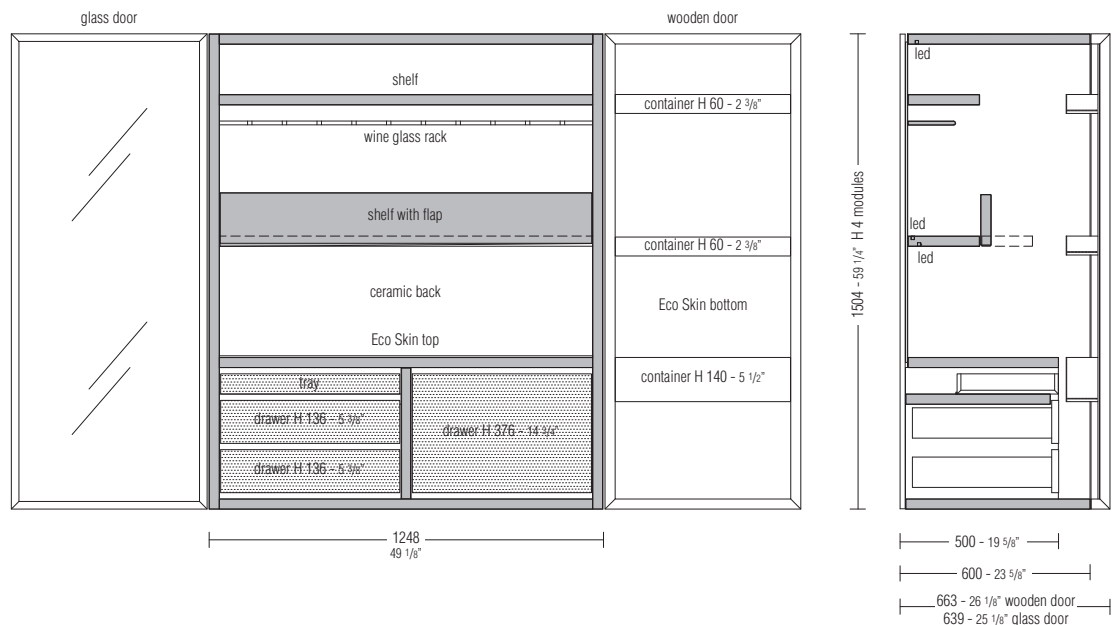

DATASHEET

REGISTERED  
DESIGN

IX.2023

## HARRY'S BAR MODULE

### Notes

- ▶ No reductions of any kind are possible.
- ▶ When ordering, please specify:
  - finish of structure components (matt lacquer)
  - fronts of internal drawers (wood)
  - finish of wood door and interior parts Eco Skin
  - finish of glass door
  - finish of top Eco Skin
  - finish of back panel

Molteni & C

### Harry's wooden door

W 1248 - 49 1/8"  
H 1504 - 59 1/4"  
D 663 - 26 1/8"

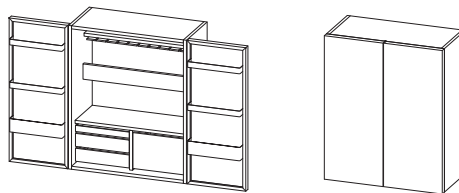

HE12/15

### Harry's glass door

W 1248 - 49 1/8"  
H 1504 - 59 1/4"  
D 639 - 25 1/8"

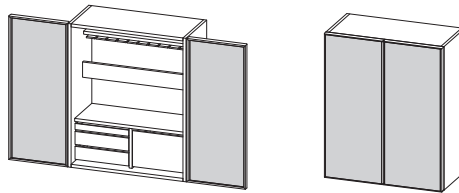

transparent stopsol glass  
stopsol glass etched  
HW12/15

Fitting  
Drawer H 136 - 5 3/8"

KIT 136A  
Base

KIT 136B  
Cocktails

KIT 136C  
Wine

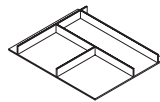

HH06/13A

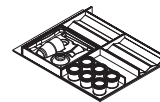

HH06/13B

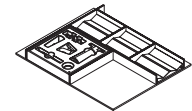

HH06/13C

Fitting  
Drawer H 376 - 14 3/4"

KIT 376A  
Base

KIT 376B  
Bottles

KIT 376C  
Plates

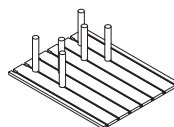

HH06/37A

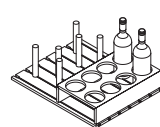

HH06/37B

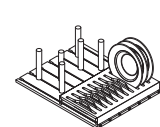

HH06/37C

DATASHEET

REGISTERED  
DESIGN

IX.2023

## HARRY'S BAR MODULE

### Fittings for drawers H 136

Drawers can be customised with the following fittings.

There can be no modifications to the kits.

### KIT 136A Base - without accessories

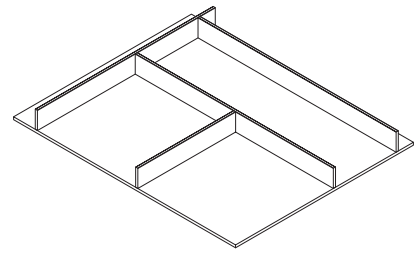
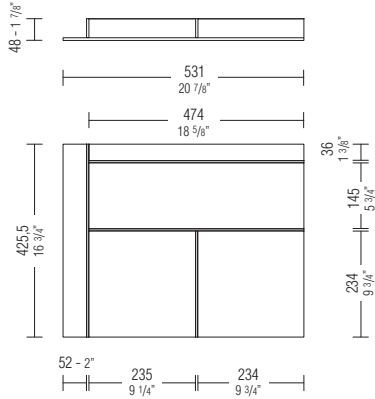

Molteni & C

24—  
28

### KIT 136B Cocktails - base with cocktail set, spice holder and drinks holder

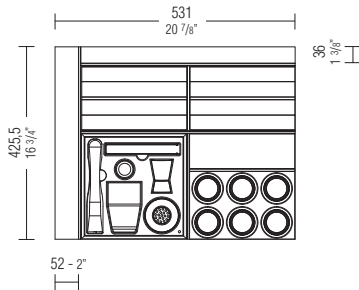

Cocktail set composed of:

- shaker
- jigger
- ice tongs
- pestle

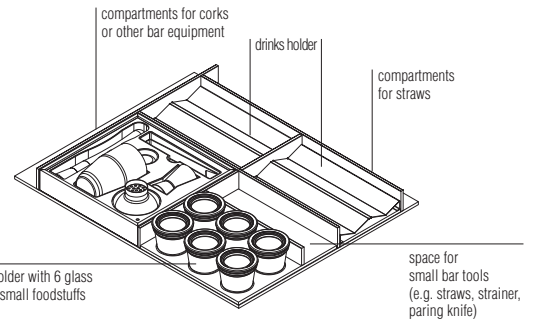

### KIT 136C Wine - base with wine set and glass holder

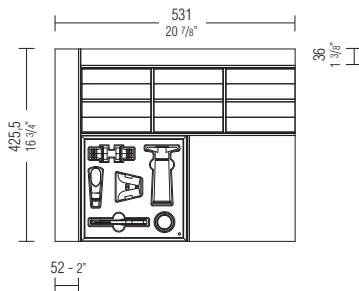

Wine set composed of:

- Roero professional corkscrew
- champagne stopper
- drip saver
- stainless steel wine pourer
- wine preserver with 2 silicone stoppers

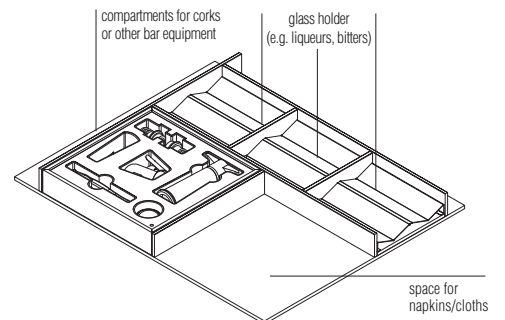

DATASHEET

REGISTERED  
DESIGN

IX.2023



## HARRY'S BAR MODULE

### Fittings for drawers H 376

Drawers can be customised with the following fittings.

There can be no modifications to the kits.

Molteni & C

25 –  
28

### KIT 376A Base - with 6 separators

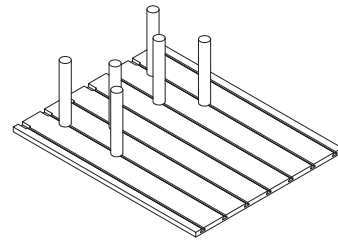
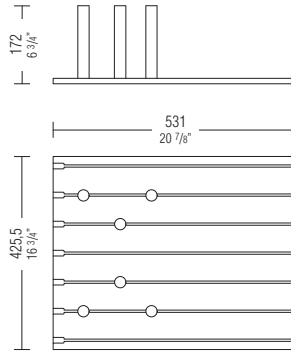

### KIT 376B Bottles - base with 6 separators and bottle holder

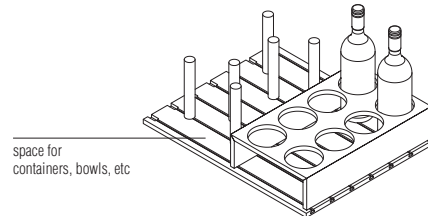
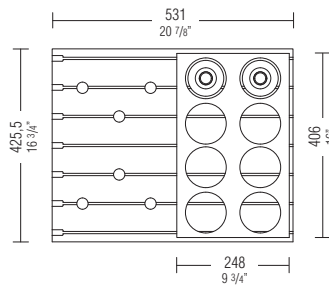

### KIT 376C Plates - base with 6 separators and plate holder

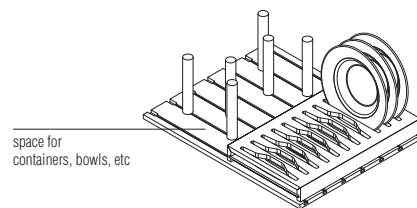
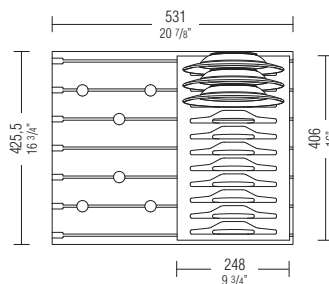

DATASHEET

REGISTERED  
DESIGN

IX.2023

**DOORS**

**pressure opening  
th 35**

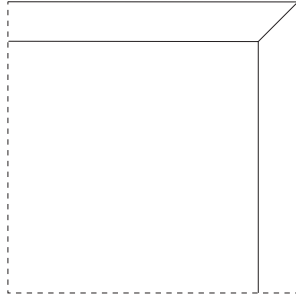

**pressure opening  
th 22**

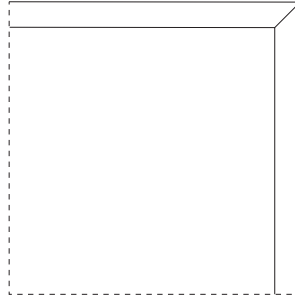

**handle opening  
th 22/35**

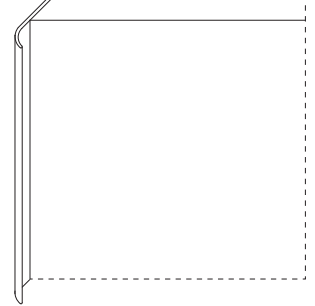

**hinged  
opening glass  
th 35**

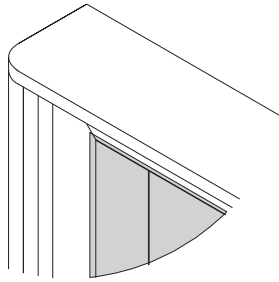

**hinged  
opening Eco Skin  
th 35**

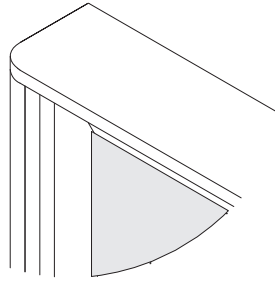

**EXTERNAL DRAWERS WITH PRESSURE OPENING D 400 - TH. 22**

Standard version comes with cushioned fully extractable runners.

\* wooden drawers only with horizontal grain

\*\* horizontal satin finish

**Reductions**

No reductions possible

**Notes**

External drawers can be inserted into compartments with a height of 1 or 2 modules with a back panel of 16 mm th.

**Drawers placed on the base**

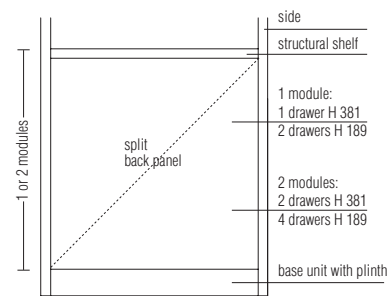

**Drawers within the unit**

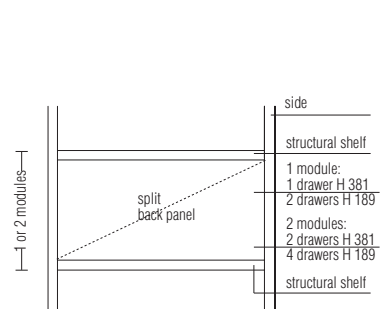

**DATASHEET**

REGISTERED  
DESIGN

IX.2023

## COMPOSITION EXAMPLES

Molteni & C

27 -  
28

### Bookshelves

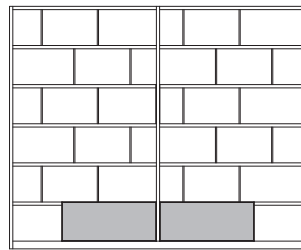
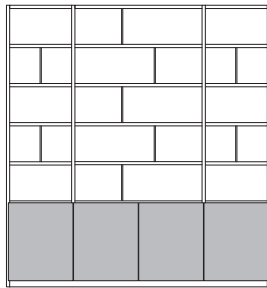
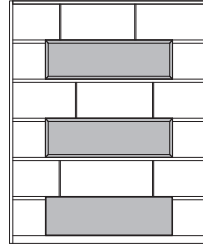
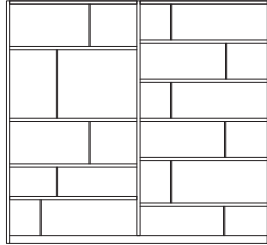

### TV compartments

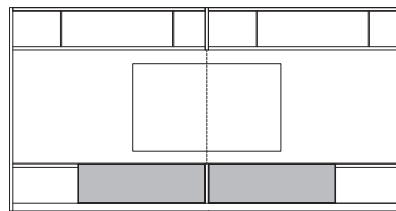
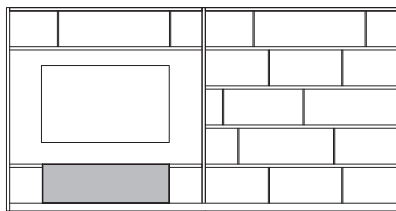

### Service elements

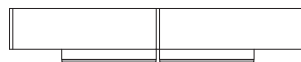
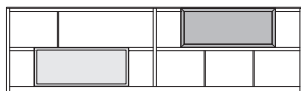

### DATASHEET

REGISTERED  
DESIGN

IX.2023

## COMPOSITION EXAMPLES

### Storage or service elements

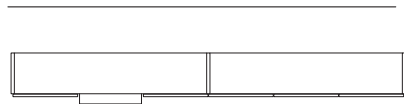
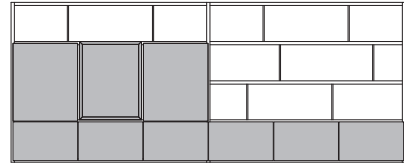
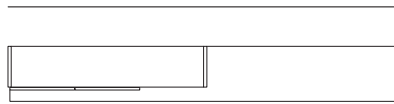
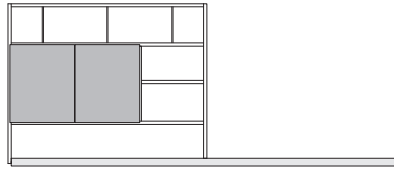

Molteni & C

28 -  
28

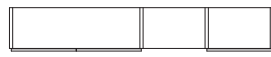
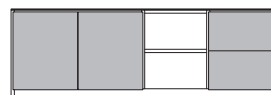
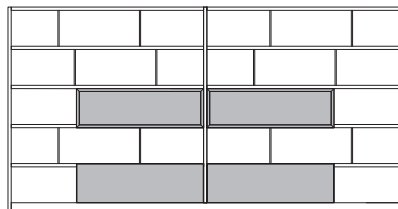
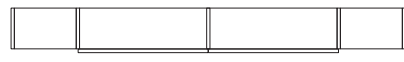
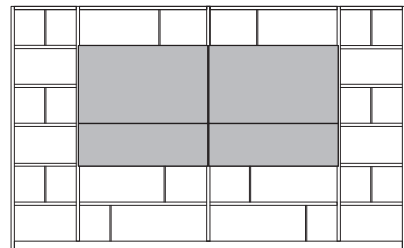
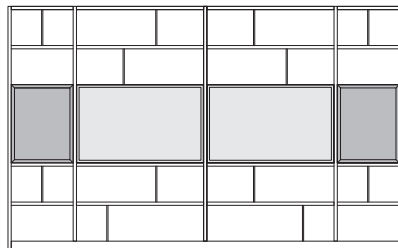
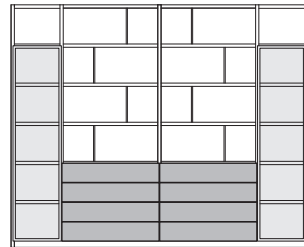
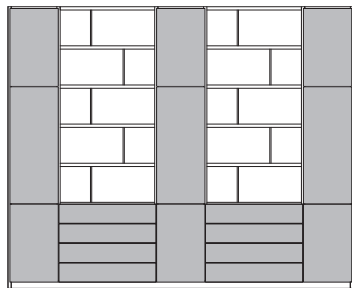

### DATASHEET

REGISTERED  
DESIGN

IX.2023