

Molteni & C

FILIGREE — RODOLFO DORDONI 2013

1—
4



Series of tables with a sinuous shape of the die-cast aluminium leg and thin tops. The extendable table provided with an invisible lateral telescopic system allows users to have: a complete table top without cross cuts, double length extensions, maximum usability of table top due to the corner legs, minimum thickness of tops, housing of the mechanism and extensions in only 38 mm (interior thickness). The tables are available in different materials and finishes to satisfy the greatest number of requirements. In 2025, Rodolfo Dordoni's Filigree table, a Molteni&C classic, is enriched with new finishes, offering new expressive possibilities for this best-selling product. The structure is now offered with a refined Iridium brown finish, a metallic surface with a warm, soft-to-the-touch tone. This new color, which integrates harmoniously with the entire Molteni&C production, is further enhanced by new tops in eucalyptus wood with inlay.

The series of Filigree tables is now completed with new tops in Ecotone™, a mineral agglomerate and the ideal solution for surfaces and finishes in line with a contemporary living style, guaranteed to deliver constantly evolving even better performance.

DATASHEET

REGISTERED
DESIGN

2026

FINITURE

FIXED TABLE TOP FINISHES

- woods: eucalyptus, thermo oak, graphite oak, coffee oak
- coloured glass in the Molteni colour range
- etched coloured glass in the Molteni colour range
- marbles: black marquina, emperador dark, white Carrara, orient grey, green alpine, silver wave, Sahara noir, calacatta, red lepanto, avocadus green
- inlaid eucalyptus
- Ecotone™: Poseidon, Sienna

STRUCTURE FINISHES

- iridium brown
- pewter colour satin finish

EXTENDABLE TABLE TOP FINISHES

- woods: eucalyptus, thermo oak, graphite oak, coffee oak
- inlaid eucalyptus

TECHNICAL INFORMATION

FIXED TABLE STRUCTURE

Extruded anodized aluminium, painted, with internal metal frame and plywood crosspieces.

EXTENDABLE TABLE STRUCTURE

Anodised extruded aluminium with internal metal frame and runners on extruded aluminium tracks. Telescopic cover profile of the extendable table in extruded plastic.

GLASS TOP

Transparent or etched extra light glass, tempered, th. 6 mm, painted in colours in the Molteni range.

WOOD TOP AND EXTENSIONS

Composite panel of medium density fibre and aluminium sheets, th. 1mm, covered in wood veneer.

MARBLE TOP

Marble in Molteni range finishes with anti-stain, water-repellent treatments.

ECOTONE™ TOP **ONLY FOR FIXED TABLES ***

Slabs produced using recycled components with some veins highly visible and others less obvious, but always through-body that preserve the characteristics of performance and durability with the added extra of a more eco-friendly formula.

FIXED TABLE BASE

Wood particleboard panel with painted melamine facing.

EXTENDABLE TABLE BASE

Medium density fibre composite panel with external surface in anodised aluminium sheet, th. 1mm.

LEGS

Die-cast aluminium: brushed, polished, chromed, or painted.

Internal metal brace and foot in non-slip plastic.

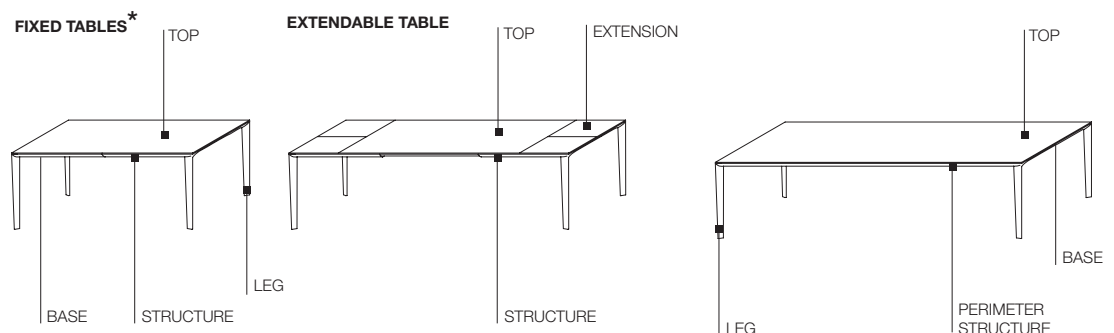

DIMENSIONS

fixed rectangular tables

FTF18/10

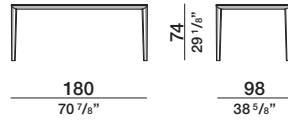

iridium brown/
 pewter colour
 satin finish
 structure

FTF21/10

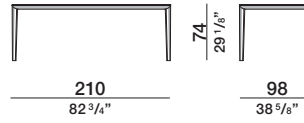

iridium brown/
 pewter colour
 satin finish
 structure

FTF24/10

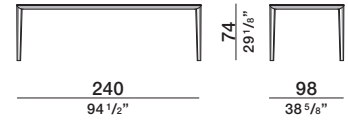

iridium brown/
 pewter colour
 satin finish
 structure

fixed rectangular table

FTF28/12

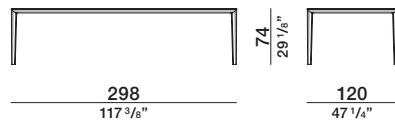

iridium brown/
 pewter colour
 satin finish
 structure

Notes

marble top W 298 not available in the following finishes:
 - Sahara noir
 - calacatta
 - red lepanto
 - avocodus green

extendable rectangular table

FTA18/10 closed

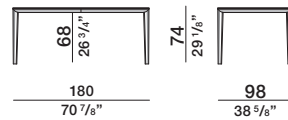

iridium brown/
 pewter colour
 satin finish
 structure

FTA18/10 partially open

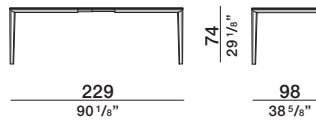

iridium brown/
 pewter colour
 satin finish
 structure

FTA18/10 fully open

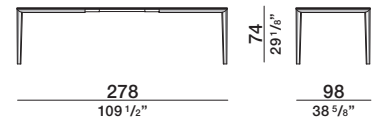

iridium brown/
 pewter colour
 satin finish
 structure

DATASHEET

REGISTERED
 DESIGN

2026

ECOTONE™ TOPS DIMENSIONS ONLY FOR FIXED TABLES

rectangular tables

FTF18/10

Ecotone™ top

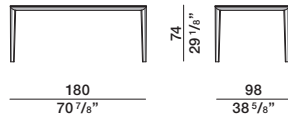

FTF21/10

Ecotone™ top

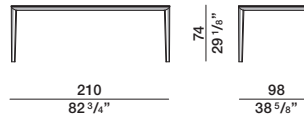

FTF24/10

Ecotone™ top

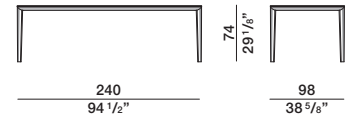

Molteni & C

rectangular table

FTF28/12

Ecotone™ top

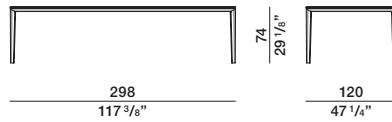

4—
4

ECOTONE™ A constant commitment to research and innovation

The new generation of slabs with recycled components 

Ecological, a resin derived from bio compounds 

A silica content of less than 5% 

A production process that uses largely energy from renewable sources, such as wind, solar and biomass 

The almost total recycling of water used by the plants 

ECOTONE™ Features



Waterproof

does not absorb liquids



Fireproof

is heat resistant and non-flammable



Anti-scratch

is difficult to scratch



Acid resistant

resists external aggressions



Shock resistant

withstands impacts well



Stain resistant

resists stains from many products and is non-porous

DATASHEET

REGISTERED
DESIGN

2026

moltenigroup.com

Dimensions in centimeters and inches. The right to discontinue and make changes is reserved. This information is based on the latest product information available at the time of printing.