

# Molteni & C

## OLD FORD — RODOLFO DORDONI 2023

1—  
3



The Old Ford table by the Italian designer Rodolfo Dordoni is a perfect embodiment of a commitment by Molteni&C in combining aesthetics, functionality, and technical innovation. The table is composed of a rounded, lozenge-shaped top that curves downward on the underside to meet four glossy lacquered legs connected by an H-shaped beam. The finely worked top is available with the choice of limba and coffee oak wood finishes, and in emperador dark, calacatta and sahara noir marble in in matt and glossy polyester version, giving it a warm and inviting appearance. The table under-top resembles a shell composed of soft lines. It is available in anthracite colour, which gives it an elegant and modern look. The contrasting-coloured legs are available in three glossy lacquered finishes, burgundy, pine green, and black nickel. The table's supportive frame is made using hydroforming, a sophisticated process commonly used in the automotive industry that uses water pressure to give shape to the material. This process allows the table to be lightweight yet strong and structurally rigid, ensuring that it can withstand the test of time. With measurements of 250 x 120 cm, or 290 x 130 cm and a height of 74 cm, the table provides ample space for seating, dining or even as a sculptural centrepiece in a foyer. The oval shape also allows the table to fit into various room layouts, making it a versatile option for any home. The Old Ford table expresses a commitment by Molteni&C to achieve aesthetic originality through research and technological innovation. The attention to detail, harmonious shapes, and exceptional durability, are evident in every aspect of its refined construction.

### DATASHEET

REGISTERED  
DESIGN

IX.2023

## FINISHES

### STRUCTURE FINISHES

glossy pine green - glossy burgundy - glossy black nickel

### FINISHES WOODEN TOPS

coffee oak - limba

### FINISHES MATT FINISH OR GLOSSY FINISH MARBLE TOPS

emperador dark - calacatta - Sahara noir

# Molteni&C

## TECHNICAL INFORMATION

### WOOD TOP

Medium density fibreboard panel shaped and covered in wood veneer.

### MARBLE TOP

Marble in the range of finishes specific for the product.

### STRUCTURE

Legs made by hydroforming and central crosspiece by hydroforming and coning, painted in the finishes of the specific range for the product. Top support frame in epoxy painted metal.

### UNDERTOP

Anthracite lacquered medium density fibreboard.

2—

3

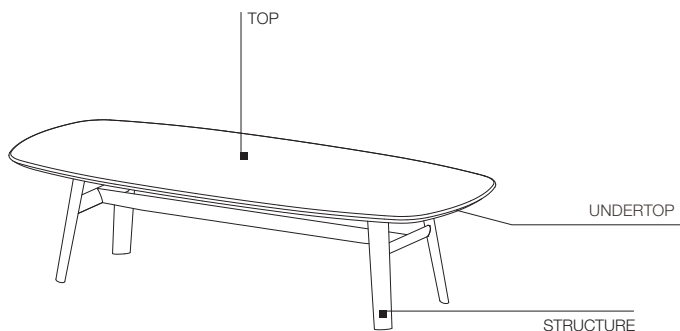

## DATASHEET

REGISTERED  
DESIGN

IX.2023

## DIMENSIONS

### Notes

No reductions of any kinds are available.

Tables

**wooden top**  
section

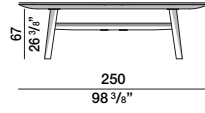
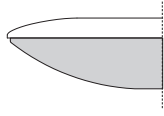

OTE2

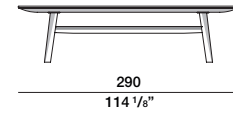
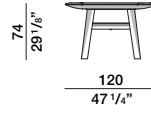

OTE3

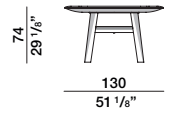

Molteni & C

3 —  
3

Tables

**marble top**  
section

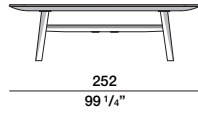
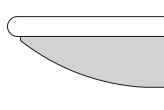

OTM2

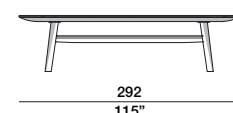
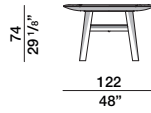

OTM3

DATASHEET

REGISTERED  
DESIGN

IX.2023