

Molteni & C

ALISEE — MATTEO NUNZIATI 2020

1—
3



A complete and perfectly calibrated system of furnishings suitable for all rooms of the home, it surprises with its aesthetic balance and the rigorous proportions of the individual components. The structure of the table creates a rhythm between solids and voids, enhanced by two finishes: pewter colour and glossy antique Gold. The two surfaces enrich the top part in wood, marble, smoked glass, and wood at the bottom. Refined materials and workmanship, attention to detail, for a family of elegant and refined contemporary furnishings.

DATASHEET

REGISTERED
DESIGN

IX.2023

FINISHES

METALLIC STRUCTURE FINISH

glossy antique gold
matt pewter colour

UPPER SHELF FINISHES

smoked glass
marble
(silver wave, green alpine,
Sahara noir, calacatta)
eucalyptus
black oak
sunrise oak

LOWER SHELF FINISHES

eucalyptus
black oak
sunrise oak

TECHNICAL INFORMATION

SMALL TABLE STRUCTURE (PAINTED)

In steel with feet in non-slip plastic.

WOOD TOPS

Chipboard panel covered with wood veneer.

MARBLE TOP

Marble th 20 mm in the finishes indicated in the price list and specific for the model, with stain resistant and water-repellent treatment.

CRYSTAL TOP

Smoked crystal glass th 10 mm.

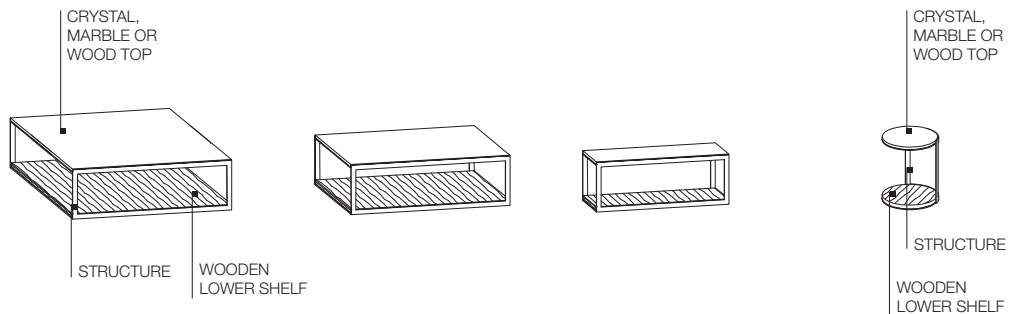

DATASHEET

REGISTERED
DESIGN

IX.2023

DIMENSIONS

Notes

- ▶ The lower shelf can only be in eucalyptus, in black oak or in sunrise oak.
- ▶ The small tables cannot be stacked and fastened together in adjacent positions.
- ▶ No reductions of any kinds or changes to finishes are available.

Small tables

Structure in
matt pewter colour
finish

ATQ1

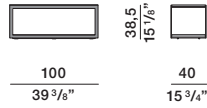

ATQ2

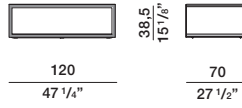

ATQ3

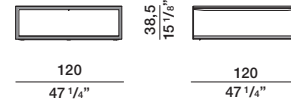

ATR1

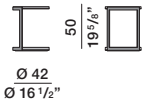

Small tables

Structure in
glossy antique gold
finish

ATQ1

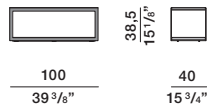

ATQ2

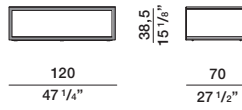

ATQ3

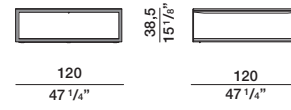

ATR1

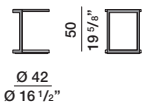

DATASHEET

REGISTERED
DESIGN

IX.2023