

# DESIGN SOLUTIONS 2022

505 UP System  
505 UP Sideboard  
Hector Bookcase  
Living Box  
Cleo  
Sutton  
Yoell  
Blevio  
Janet  
Gliss Master  
Aldgate  
7070

Molteni & C

## DESIGN SOLUTIONS 2022

505 UP System	3
505 UP Sideboard	18
Hector Bookcase	21
Living Box	31
Cleo	47
Sutton	47
Yoell	47
Blevio	73
Janet	73
Gliss Master	81
Aldgate	93
7070	93



**505 UP**  
**System / Sideboard**  
Nicola Gallizia

# VISUAL INDEX

COMPOSITION 1  
pagina 6



COMPOSITION 2  
page 7



COMPOSITION 9  
page 14



COMPOSITION 10  
page 15



COMPOSITION 3  
page 8



COMPOSITION 4  
page 9



COMPOSITION 11  
page 16



COMPOSITION 12  
page 17



COMPOSITION 5  
page 10



COMPOSITION 6  
page 11



COMPOSITION 13  
page 18



COMPOSITION 14  
page 18



COMPOSITION 7  
page 12



COMPOSITION 8  
page 13



COMPOSITION 15  
page 18



# 505 UP System

1



2



**STRUCTURE**  
PETROLEUM BLUE GLOSSY LACQUER

**BACKS**  
GRAPHITE OAK

**CENTRAL DIVIDING PANEL**  
PEWTER COLOUR METAL

**LED LIGHTING, RADIO CONTROL KIT**

**HARRY'S BAR MODULE**

*STRUCTURE*  
PETROLEUM BLUE MATT LACQUER

*BACK PANEL*  
CALACATTA VENA VECCHIA CERAMIC

*DOORS*  
TRANSPARENT STOPSOL GLASS WITH PEWTER COLOUR PROFILE

*WINE GLASS RACK, SHELF WITH FLAP*  
PEWTER COLOUR MATT LACQUER

*DRAWER TOP UNIT*  
GREY ECO SKIN

*DRAWERS, TRAY*  
GRAPHITE OAK

**STRUCTURE, BACKS**  
STARDUST MATT LACQUER

**DOORS**  
TRANSPARENT STOPSOL GLASS WITH PEWTER COLOUR FRAME

**CENTRAL DIVIDING PANELS**  
PEWTER COLOUR METAL

**LED LIGHTING, RADIO CONTROL KIT**

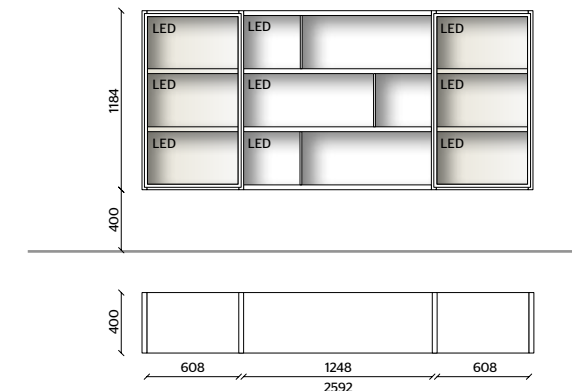
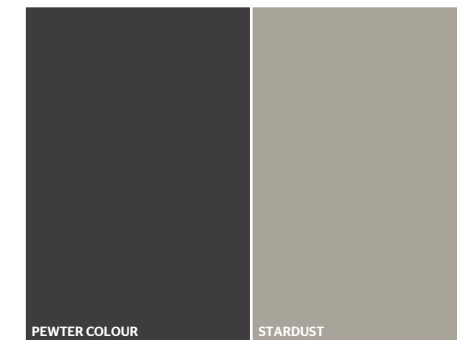
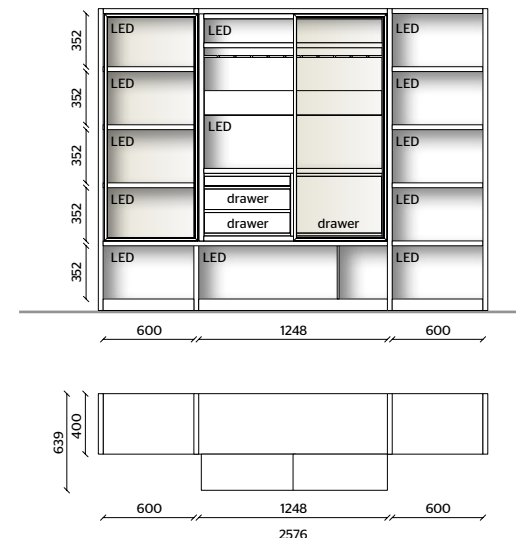
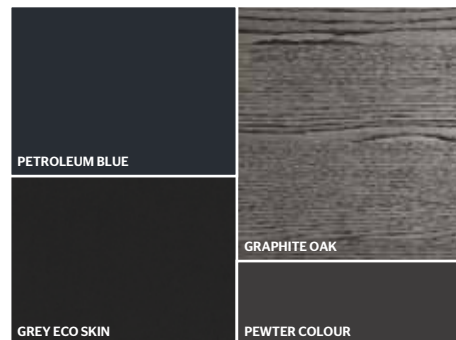

# 505 UP System

3



**STRUCTURE, BACKS**  
STARDUST MATT LACQUER

**DOORS**  
TRANSPARENT STOPSOL GLASS  
WITH PEWTER COLOUR FRAME

**DRAWERS**  
SUNRISE OAK

**LED LIGHTING,  
RADIO CONTROL KIT**

THE LACQUERED OR WOODEN DOORS  
AND DRAWERS ARE 22 MM THICK

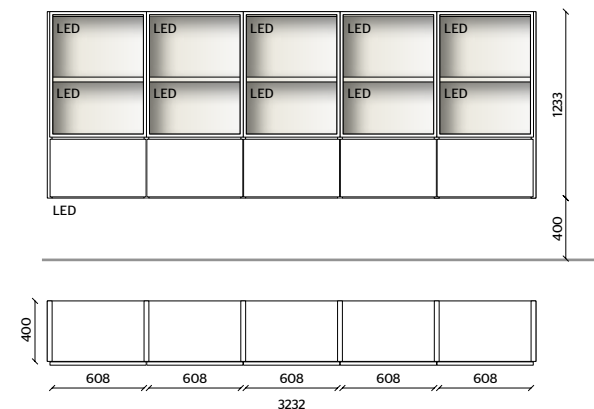
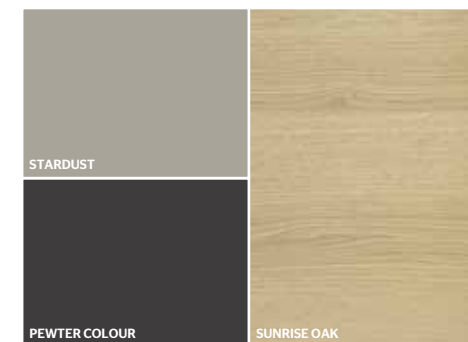

4



**STRUCTURE**  
LONDON SKY MATT LACQUER

**BACKS**  
SUNRISE OAK RAYS

**DOORS**  
SUNRISE OAK

**PROTRUDING SHELF**  
HEMP ECO SKIN  
WITH IRIS METAL SHELF EDGING

**CENTRAL DIVIDING PANELS**  
IRIS METAL

**LED LIGHTING,  
RADIO CONTROL KIT**

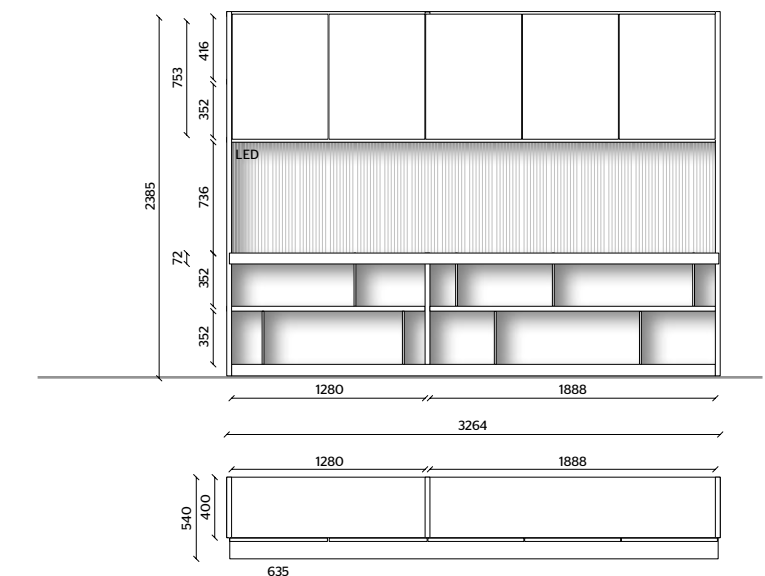
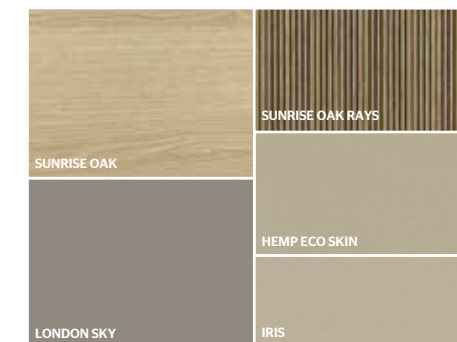

# 505 UP System

5



- STRUCTURE**  
LONDON SKY MATT LACQUER
- BACKS**  
SUNRISE OAK  
SUNRISE OAK RAYS
- PROTRUDING SHELF**  
HEMP ECO SKIN  
WITH IRIS METAL SHELF EDGING
- CENTRAL DIVIDING PANELS**  
IRIS METAL
- LED LIGHTING,**  
RADIO CONTROL KIT

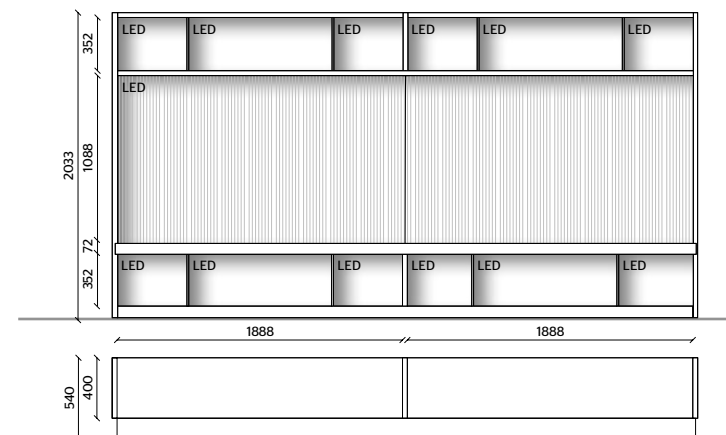
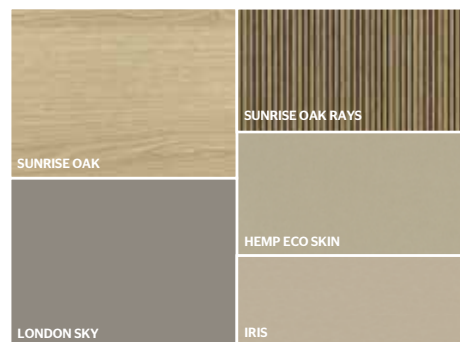

6



- STRUCTURE**  
MOKA MATT LACQUER
- BACKS**  
SUNRISE OAK  
SUNRISE OAK RAYS
- DISPLAY WITH VERTICAL SLIDING DOOR**  
MOKA MATT LACQUER,  
TRANSPARENT STOPSOL GLASS DOOR  
WITH IRIS FRAME,  
INTERNAL SHELF  
TRANSPARENT GLASS
- PROTRUDING SHELF**  
HEMP ECO SKIN  
WITH IRIS METAL SHELF EDGING
- CENTRAL DIVIDING PANELS**  
IRIS METAL
- LED LIGHTING,**  
RADIO CONTROL KIT

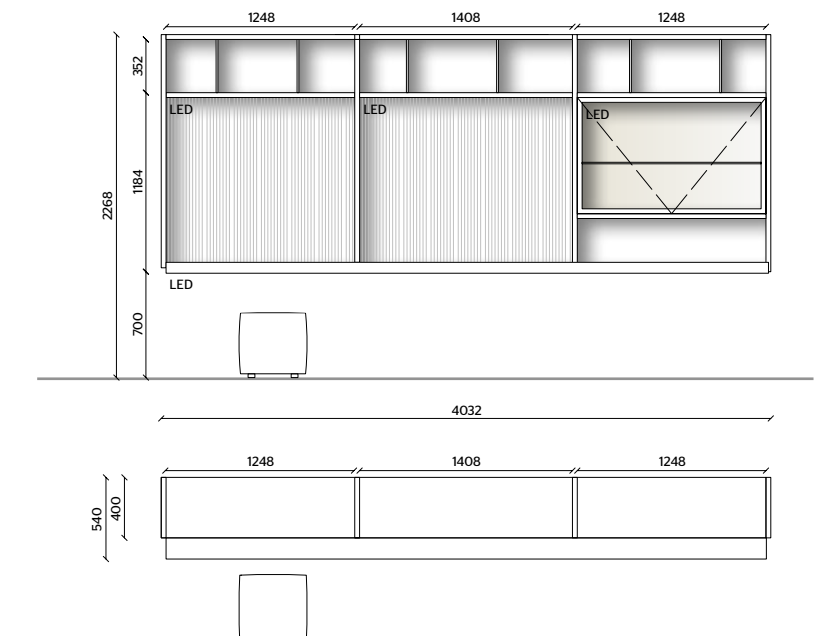
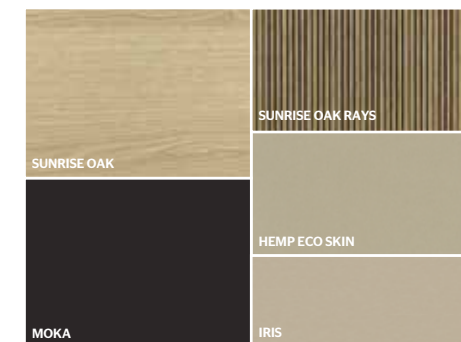

# 505 UP System

7



**STRUCTURE**  
STARDUST MATT LACQUER

**BACKS**  
ANTHRACITE MATT LACQUER

**CENTRAL DIVIDING PANELS**  
PEWTER COLOUR METAL

**LED LIGHTING,**  
**RADIO CONTROL KIT**

**HARRY'S BAR MODULE**

**STRUCTURE**  
STARDUST MATT LACQUER

**BACK PANEL**  
CALACATTA VENA VECCHIA CERAMIC

**DOORS**  
TRANSPARENT STOPSOL GLASS  
WITH PEWTER COLOUR PROFILE

**WINE GLASS RACK**  
**SHELF WITH FLAP**  
PEWTER COLOUR MATT LACQUER

**DRAWER TOP UNIT**  
DARK BROWN ECO SKIN

**DRAWERS, TRAY**  
SUNRISE OAK

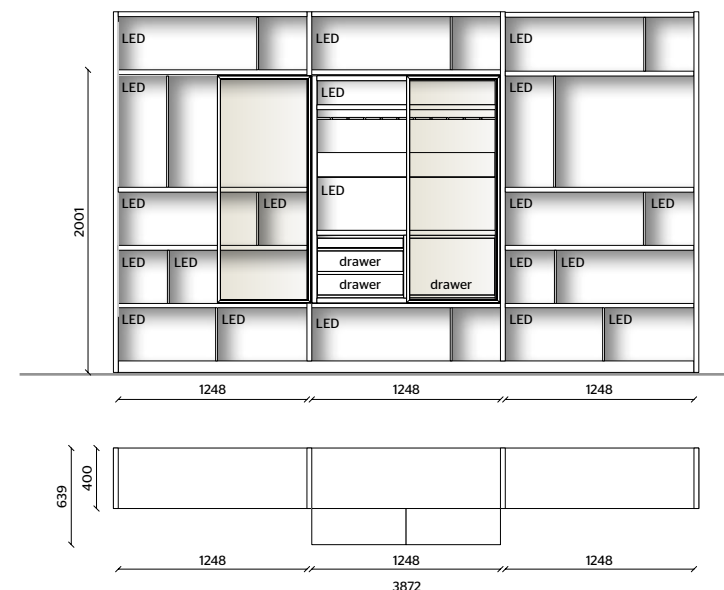
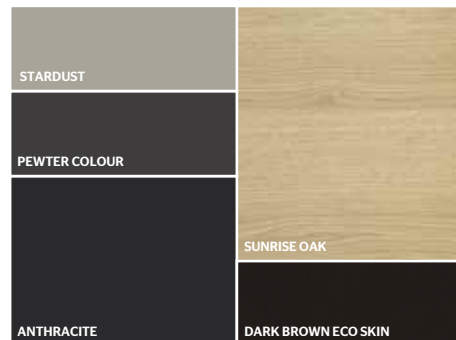

8



**STRUCTURE**  
COPPER MATT LACQUER

**BACKS**  
DOVE GREY GLOSSY LACQUER

**BOISERIE / BACK FOR TV**  
EUCALYPTUS RAYS

**DISPLAY, FLAP DOOR**  
EUCALYPTUS

**DOORS**  
TRANSPARENT STOPSOL GLASS  
WITH IRIS FRAME

**CENTRAL DIVIDING PANELS**  
IRIS METAL

**LED LIGHTING,**  
**RADIO CONTROL KIT**

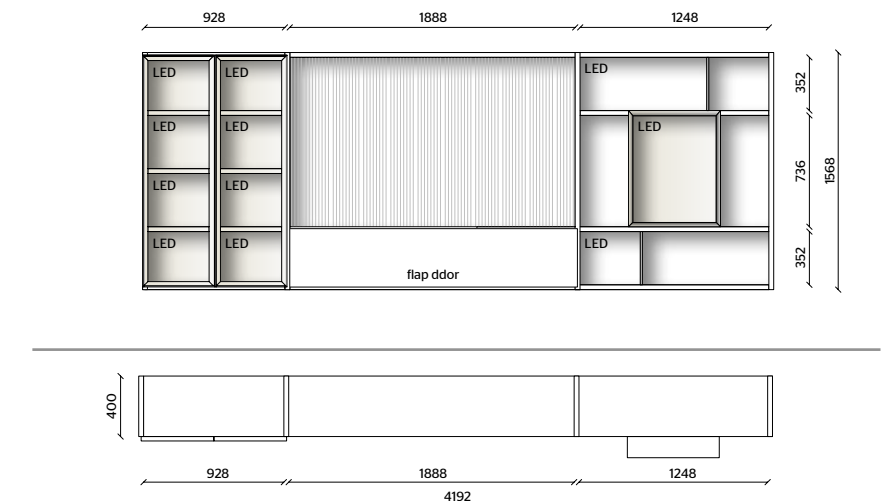



# 505 UP System

9



**STRUCTURE**  
PEWTER COLOUR MATT LACQUER

**BACKS, DISPLAY, DRAWER**  
SUNRISE OAK

**BOISERIE / BACK FOR TV**  
SUNRISE OAK RAYS

**CENTRAL DIVIDING PANELS**  
PEWTER COLOUR METAL

**LED LIGHTING,  
RADIO CONTROL KIT**

THE LACQUERED OR WOODEN DOORS  
AND DRAWERS ARE 22 MM THICK

**HARRY'S BAR MODULE**  
*STRUCTURE, WINE GLASS RACK,  
SHELF WITH FLAP*  
PEWTER COLOUR MATT LACQUER

*BACK PANEL*  
CALACATTA VENA VECCHIA CERAMIC

*DOORS, DRAWERS, TRAY*  
SUNRISE OAK

*DRAWER TOP UNIT,  
CONTAINERS*  
DARK BROWN ECO SKIN

10



**STRUCTURE, BACKS, DOORS**  
LIGHT BLUE GREY GLOSSY LACQUER

**DISPLAY, FLOOR-RESTING BASE UNIT**  
EUCALYPTUS

**LED LIGHTING,  
RADIO CONTROL KIT**

THE LACQUERED OR WOODEN DOORS  
AND DRAWERS ARE 22 MM THICK

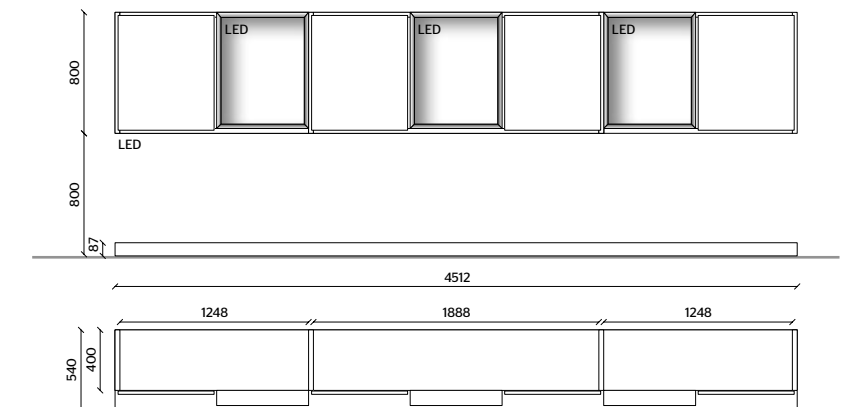
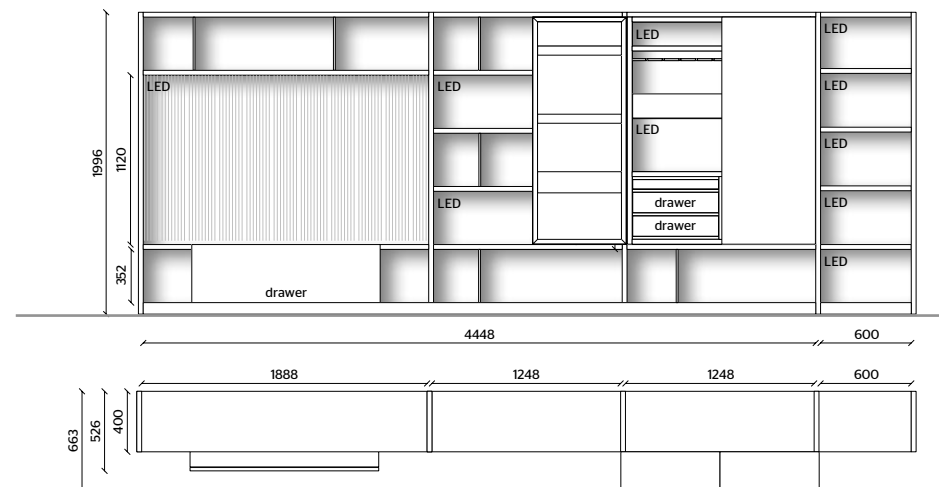

# 505 UP System

11

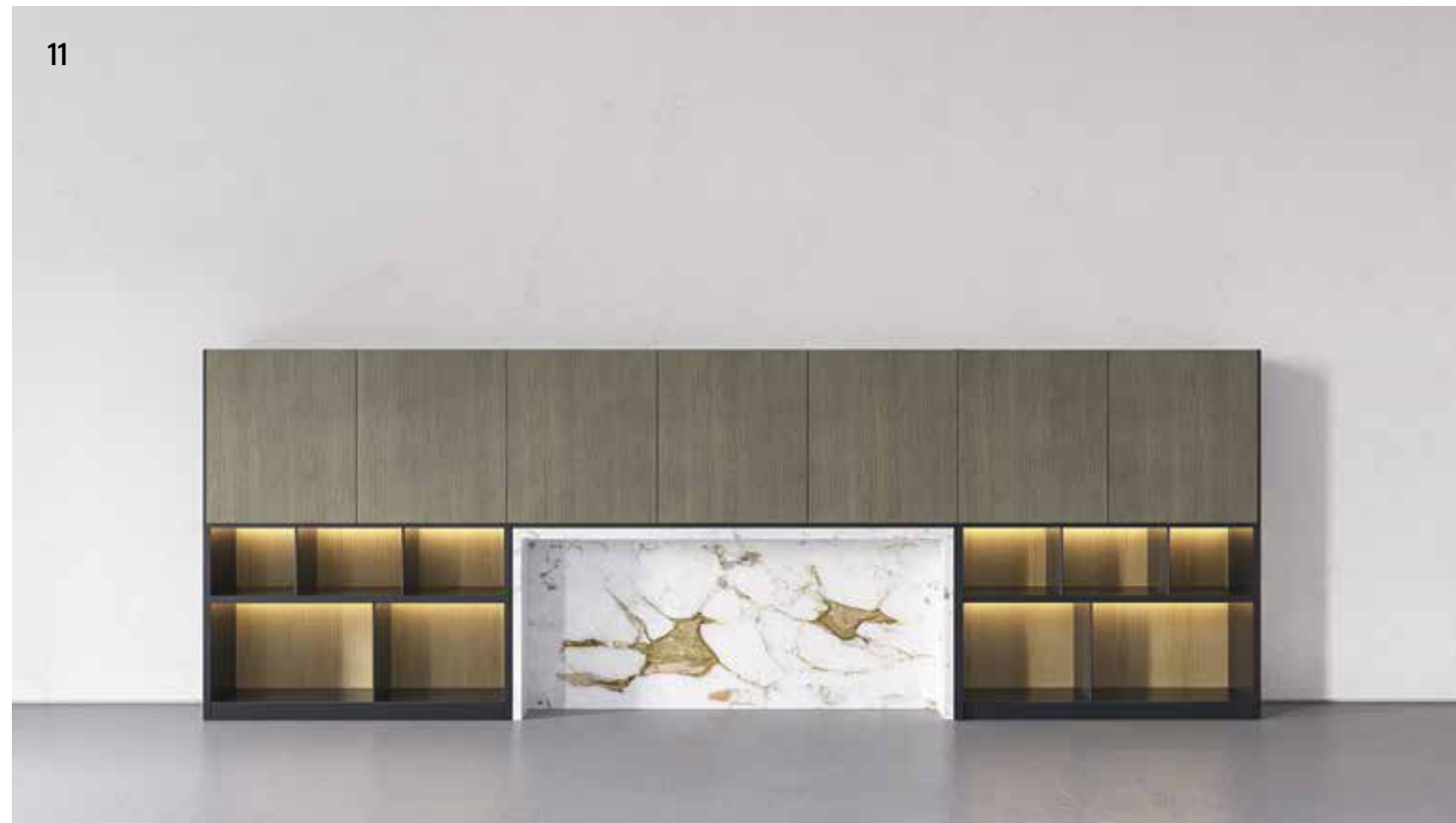

- STRUCTURE**  
ANTHRACITE MATT LACQUER
- BACKS**  
SUNRISE OAK
- DOORS**  
GLAZE SPECIAL LACQUER
- CENTRAL DIVIDING PANELS**  
PEWTER COLOUR METAL
- LED LIGHTING,**  
**RADIO CONTROL KIT**

THE LACQUERED OR WOODEN DOORS AND DRAWERS ARE 22 MM THICK

MARBLE FIREPLACE FOR PRESENTATION PURPOSES ONLY (NOT INCLUDED IN THE PRICE)

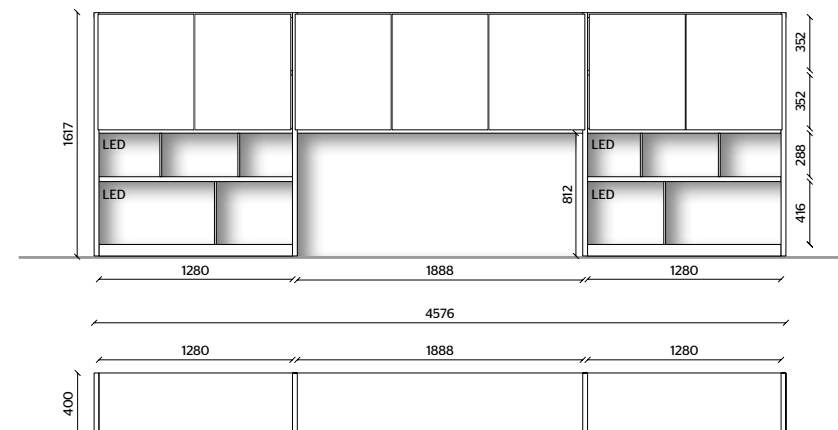

12



- STRUCTURE**  
PEWTER COLOUR MATT LACQUER
- BACKS, DISPLAY**  
SUNRISE OAK
- DISPLAY DOORS**  
TRANSPARENT GLASS WITH PEWTER COLOUR FRAME
- CENTRAL DIVIDING PANELS**  
PEWTER COLOUR METAL
- LED LIGHTING,**  
**RADIO CONTROL KIT**

- HARRY'S BAR MODULE**  
*STRUCTURE, WINE GLASS RACK, SHELF WITH FLAP*  
PEWTER COLOUR MATT LACQUER
- BACK PANEL*  
CALACATTA VENA VECCHIA CERAMIC
- DOORS*  
SUNRISE OAK WITH GREY ECO SKIN BACKS
- DRAWER TOP UNIT, CONTAINERS*  
GREY ECO SKIN

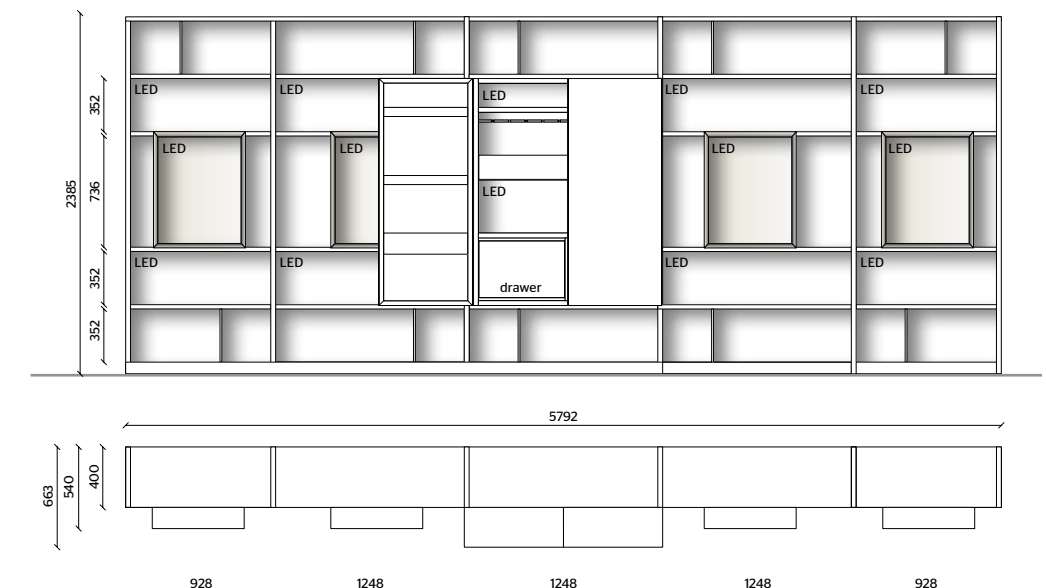

# 505 UP Sideboard

13



**STRUCTURE, TOP**  
LONDON SKY GLOSSY LACQUER

**DOORS**  
TRANSPARENT STOPSOL GLASS  
WITH IRIS PROFILE

**METAL BASE**  
IRIS METAL

**LED LIGHTING,**  
RADIO CONTROL KIT

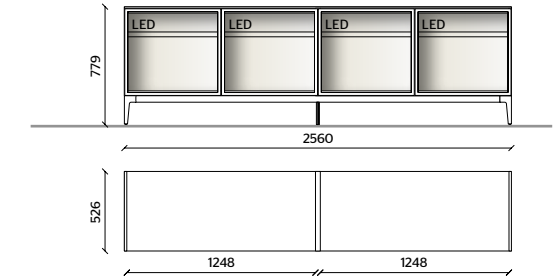
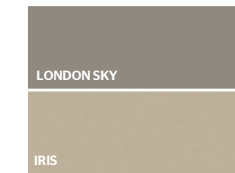

14



**STRUCTURE**  
EUCALYPTUS

**TOP**  
ORIENT GREY MARBLE

**DOORS**  
TRANSPARENT STOPSOL GLASS  
WITH IRIS PROFILE

**METAL BASE**  
IRIS METAL

**LED LIGHTING,**  
RADIO CONTROL KIT

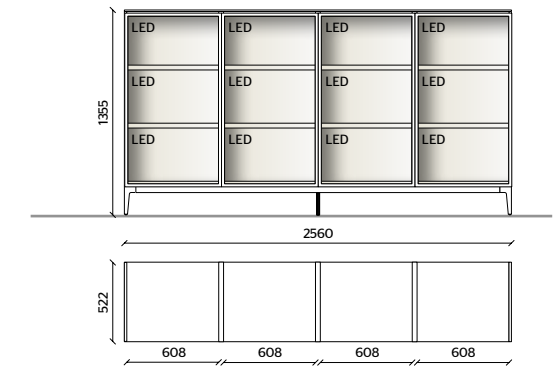
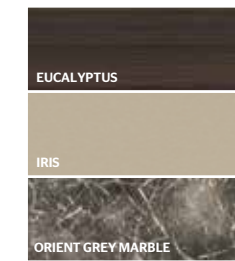

15



**STRUCTURE, DRAWERS**  
GRAPHITE OAK

**TOP**  
WHITE CARRARA MARBLE

**METAL BASE**  
PEWTER COLOUR METAL

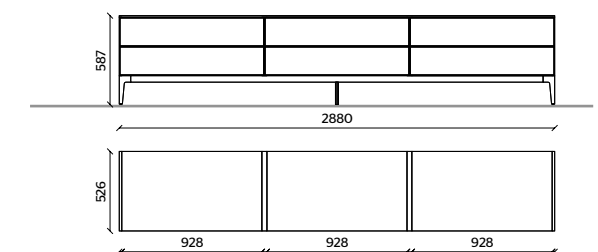
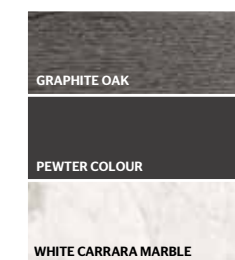



# HECTOR BOOKCASE

Vincent Van Duysen

Molteni & C

# VISUAL INDEX

COMPOSITION 1

page 24



COMPOSITION 2

page 25



COMPOSITION 3

page 26

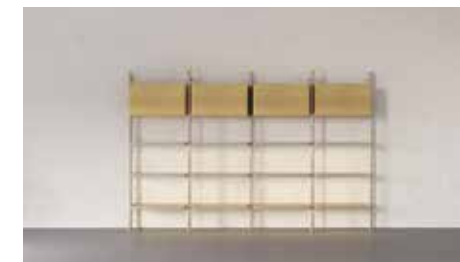

COMPOSITION 4

page 27



COMPOSITION 5

page 28



COMPOSITION 6

page 29



# Hector Bookcase



CEILING BRACKETS,  
DRAWERS  
SUNRISE OAK

SHELVES FRAME  
IRIS

SHELVES INSERT  
TRANSPARENT GLASS,  
SUNRISE OAK

LED LIGHTING,  
RADIO CONTROL KIT

CEILING BRACKETS,  
SHELVES FRAME  
PEWTER COLOUR

SHELVES INSERT,  
DRAWERS,  
DECODER CONTAINER  
WITH LOWER FLAP DOOR  
BLACK OAK

TV SUPPORT MODULE

LED LIGHTING,  
RADIO CONTROL KIT

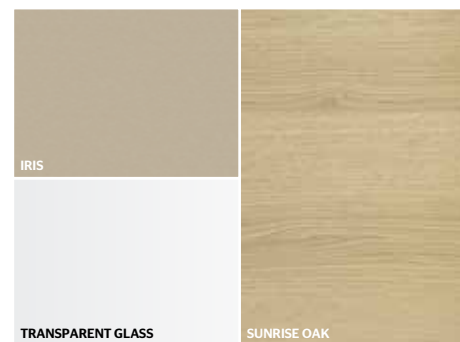

RS\_SUNRISE OAK

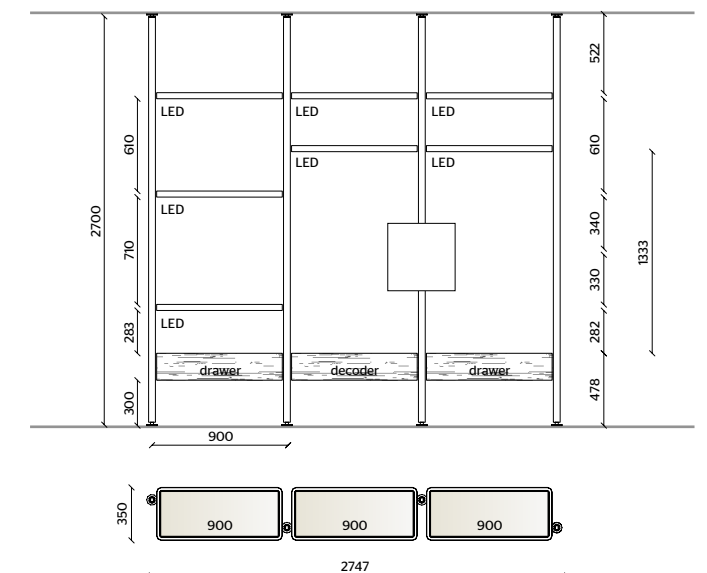
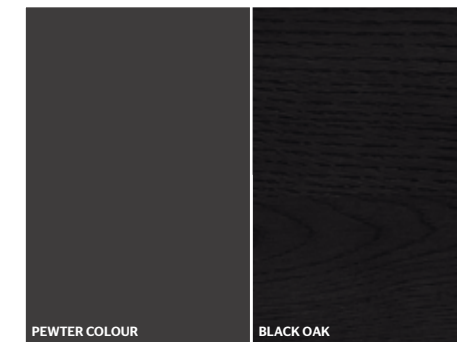
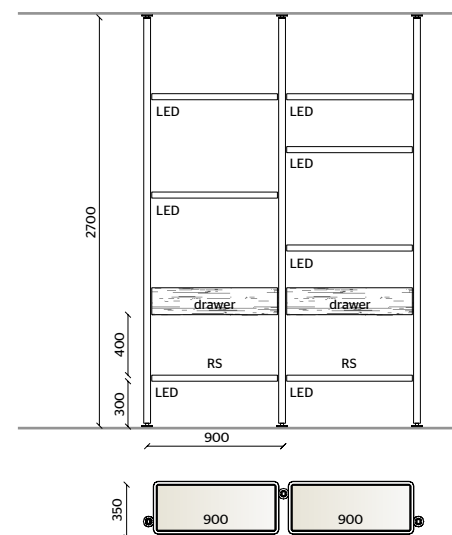

# Hector Bookcase



WALL-MOUNTED BRACKETS,  
SHELVES FRAME  
IRIS

SHELVES INSERT  
TRANSPARENT GLASS,  
SUNRISE OAK

CONTAINERS WITH  
UPPER FLAP DOORS  
SUNRISE OAK

LED LIGHTING,  
RADIO CONTROL KIT

WALL-MOUNTED BRACKETS,  
DRAWERS  
SUNRISE OAK

SHELVES FRAME  
IRIS

SHELVES INSERT  
TRANSPARENT GLASS,  
SUNRISE OAK

LED LIGHTING,  
RADIO CONTROL KIT

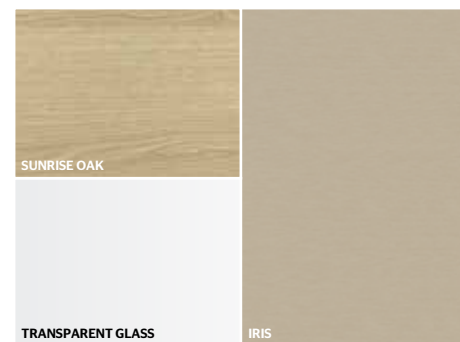

RS\_SUNRISE OAK

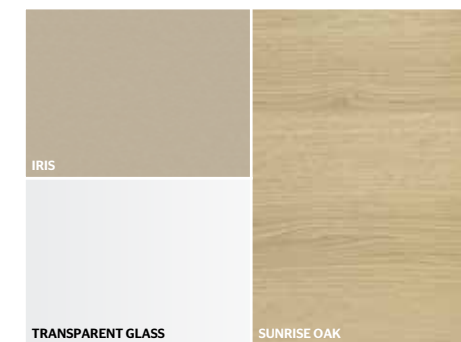
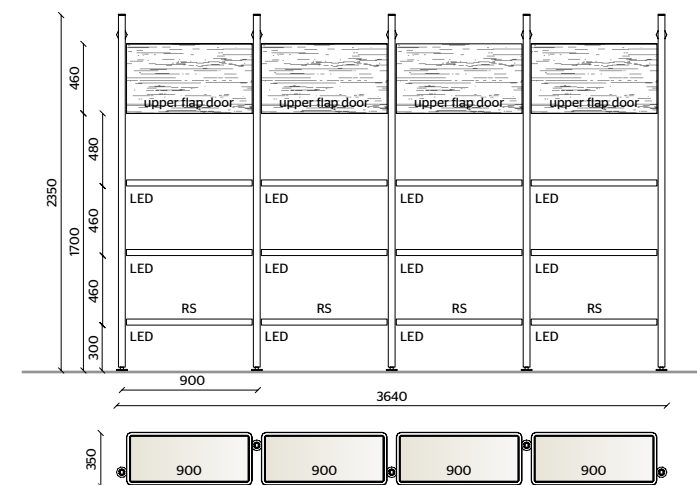

RS\_SUNRISE OAK

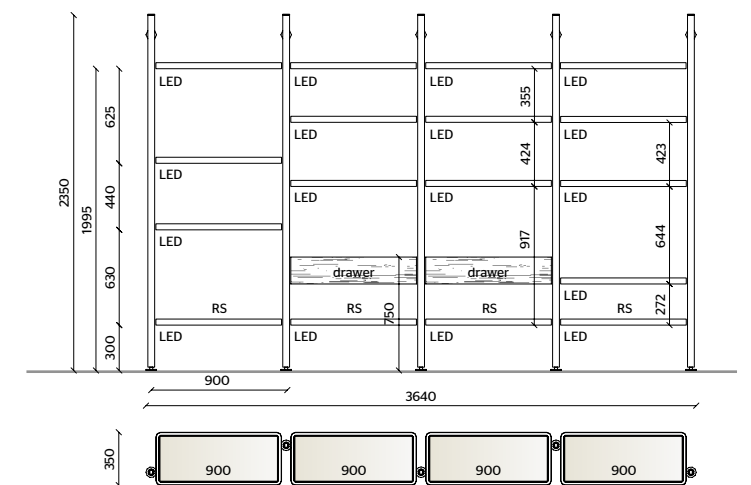

# Hector Bookcase



**5**

WALL-MOUNTED BRACKETS,  
SHELVES FRAME  
IRIS

SHELVES INSERT  
SUNRISE OAK,  
IRIS MATT LACQUER

DRAWERS, CONTAINERS  
WITH UPPER AND  
LOWER FLAP DOORS  
SUNRISE OAK

LED LIGHTING,  
RADIO CONTROL KIT



**6**

CEILING BRACKETS,  
DRAWERS AND CONTAINERS  
WITH FLAP DOOR  
BLACK OAK

SHELVES FRAME  
PEWTER COLOUR

SHELVES INSERT  
SMOKED GLASS,  
PEWTER COLOUR MATT LACQUER

LED LIGHTING,  
RADIO CONTROL KIT



IX\_IRIS MATT LACQUER

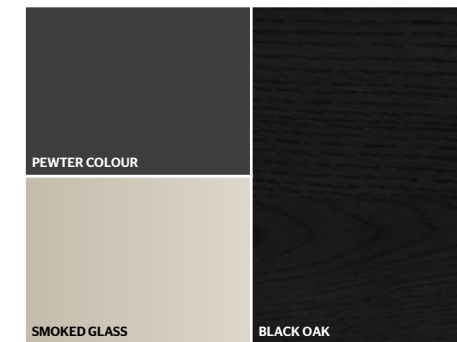
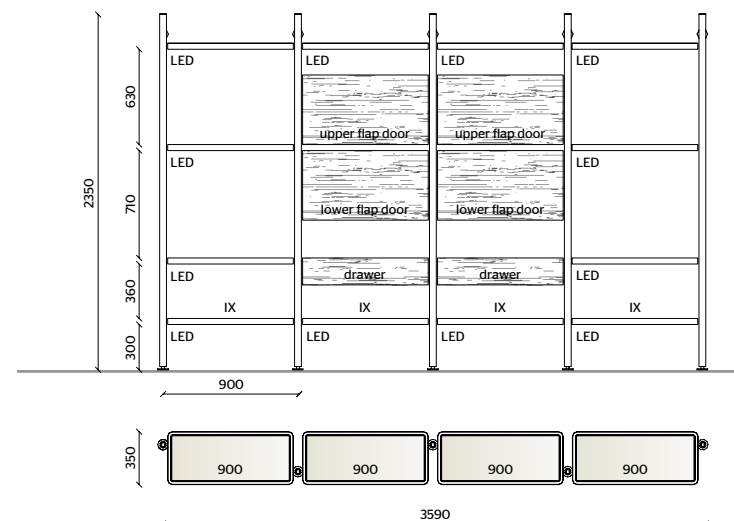

PX\_PEWTER COLOUR MATT LACQUER

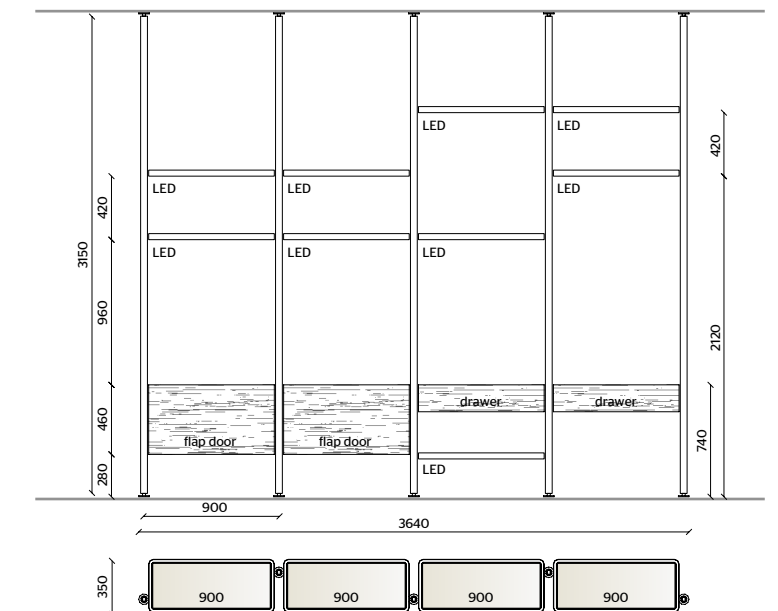





## LIVING BOX

Vincent Van Duysen

Molteni & C

# VISUAL INDEX

COMPOSITION 1  
page 34



COMPOSITION 2  
page 34



COMPOSITION 7  
page 40



COMPOSITION 8  
page 40



COMPOSITION 3  
page 36



COMPOSITION 4  
page 36



COMPOSITION 9  
page 42



COMPOSITION 10  
page 42



COMPOSITION 5  
page 38



COMPOSITION 6  
page 38



COMPOSITION 11  
page 44



# Living Box

1



- BOX STRUCTURE**  
EUCALYPTUS
- TOP INSERT**  
SAHARA NOIR MARBLE
- TOP FRAME**  
PEWTER COLOUR METAL
- TAPE MODULE**  
PEWTER COLOUR PAINTED
- LED LIGHTING,**  
RADIO CONTROL KIT

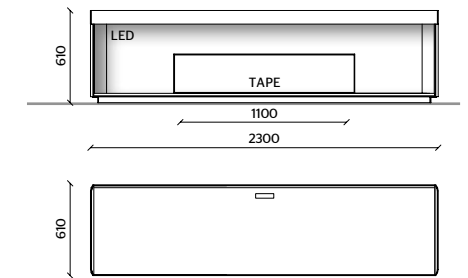
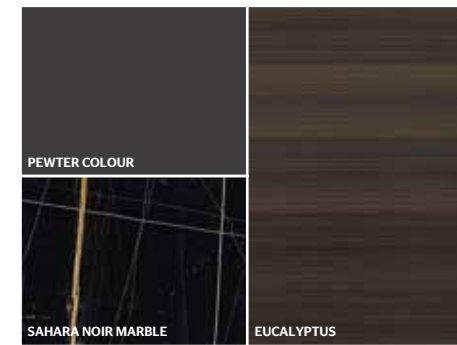

2



- BOX STRUCTURE, TOP INSERT**  
SUNRISE OAK
- TOP FRAME**  
IRIS METAL
- DRAWER AND TAPE MODULES**  
SUNRISE OAK
- LED LIGHTING,**  
RADIO CONTROL KIT

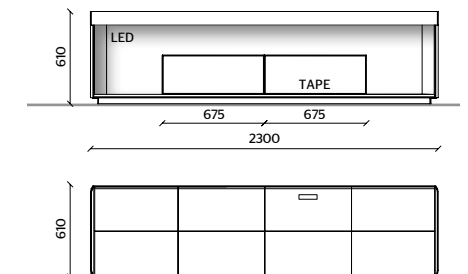

# Living Box

3



- BOX STRUCTURE**  
SUNRISE OAK
- TOP INSERT**  
BRECCIA CAPRAIA MARBLE
- TOP FRAME**  
PEWTER COLOUR METAL
- DRAWERS AND TAPE MODULES**  
PEWTER COLOUR PAINTED
- LED LIGHTING,**  
RADIO CONTROL KIT

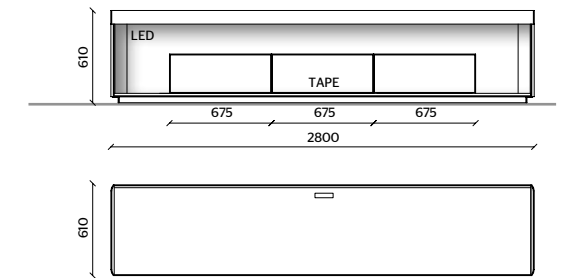
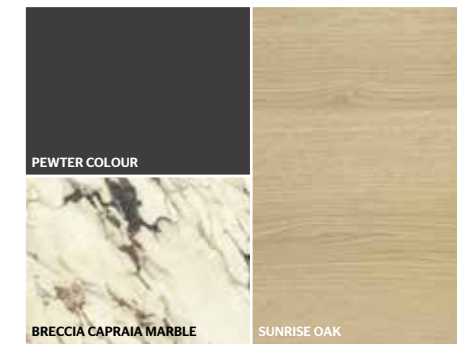

4



- BOX STRUCTURE, TOP INSERT**  
EUCALYPTUS
- TOP FRAME**  
IRIS METAL
- DRAWER AND TAPE MODULES**  
PEWTER COLOUR PAINTED
- LED LIGHTING,**  
RADIO CONTROL KIT

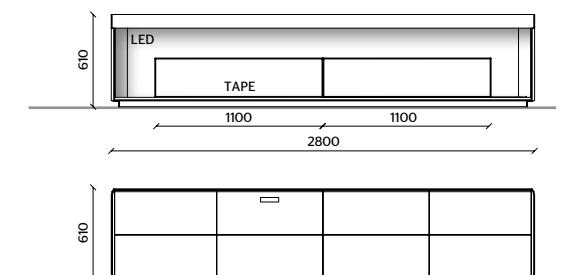

# Living Box

5



**BOX STRUCTURE, TOP INSERT**  
SUNRISE OAK  
**TOP FRAME**  
PEWTER COLOUR METAL  
**DRAWERS MODULES**  
PEWTER COLOUR PAINTED  
**LED LIGHTING,**  
RADIO CONTROL KIT

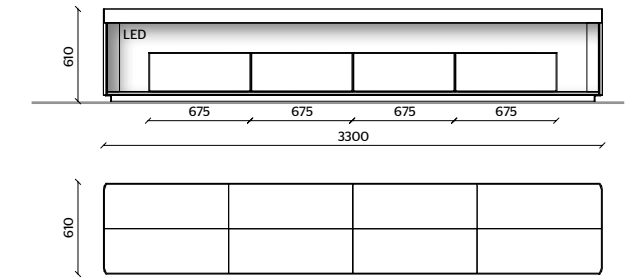

6



**BOX STRUCTURE**  
EUCALYPTUS  
**TOP INSERT**  
SAHARA NOIR MARBLE  
**TOP FRAME**  
IRIS METAL  
**DRAWERS MODULES**  
EUCALYPTUS  
**LED LIGHTING,**  
RADIO CONTROL KIT

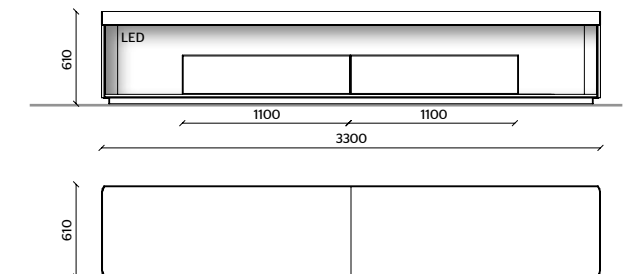

# Living Box

7



- BOX STRUCTURE**  
EUCALYPTUS
- TOP INSERT**  
EMPERADOR DARK MARBLE
- TOP FRAME**  
PEWTER COLOUR METAL
- DRAWERS MODULES**  
PEWTER COLOUR PAINTED
- LED LIGHTING,**  
RADIO CONTROL KIT

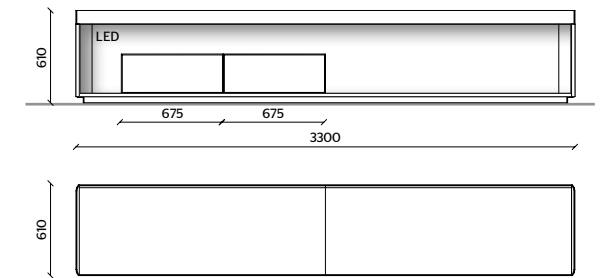
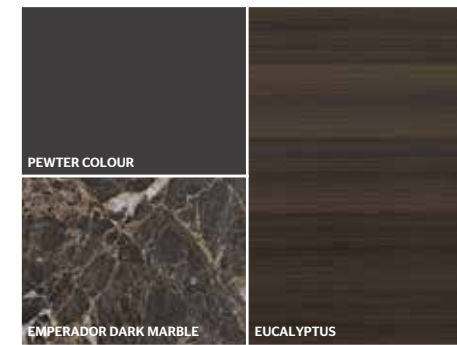

8



- BOX STRUCTURE, TOP INSERT**  
SUNRISE OAK
- TOP FRAME**  
IRIS METAL
- DRAWERS MODULES**  
IRIS PAINTED
- LED LIGHTING,**  
RADIO CONTROL KIT

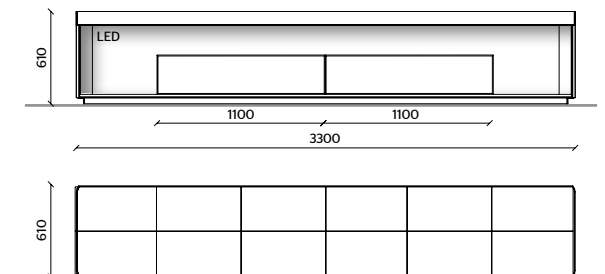

# Living Box

9



- BOX STRUCTURE**  
EUCALYPTUS
- TOP INSERT**  
BRECCIA CAPRAIA MARBLE
- TOP FRAME**  
PEWTER COLOUR METAL
- DRAWERS AND TAPE MODULES**  
PEWTER COLOUR PAINTED
- LED LIGHTING,**  
RADIO CONTROL KIT

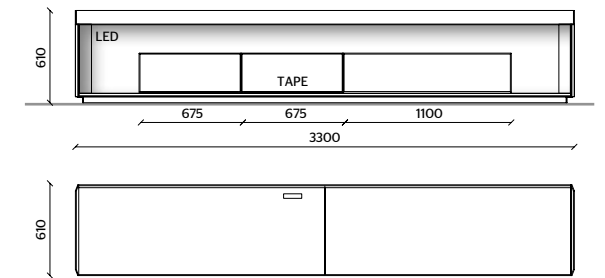
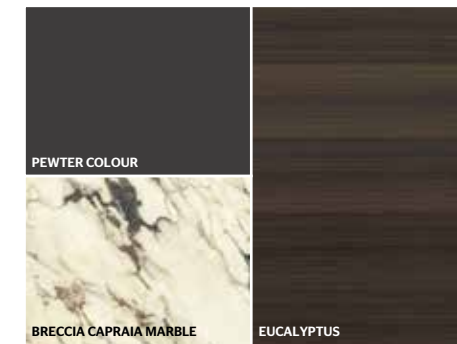

10



- BOX STRUCTURE, TOP INSERT**  
EUCALYPTUS
- TOP FRAME**  
IRIS METAL
- DRAWER AND TAPE MODULES**  
IRIS PAINTED
- LED LIGHTING,**  
RADIO CONTROL KIT

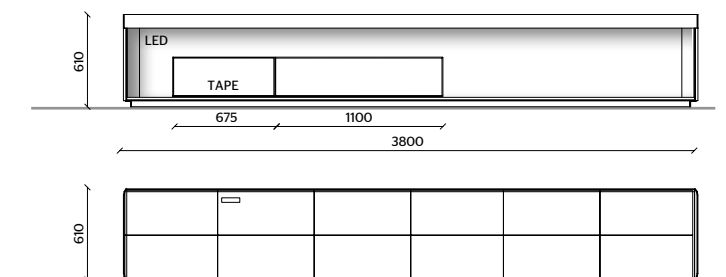
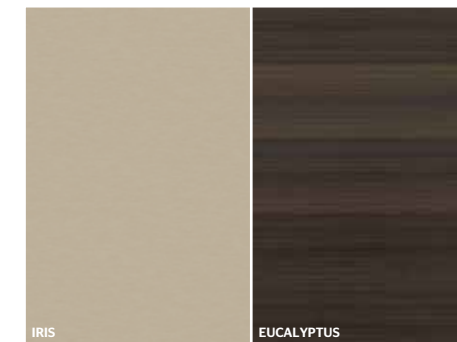

# Living Box

11



## BOX STRUCTURE

SUNRISE OAK

## TOP INSERT

EMPERADOR DARK MARBLE

## TOP FRAME

PEWTER COLOUR METAL

## DRAWERS MODULES

SUNRISE OAK WITH

LED LIGHTING,

RADIO CONTROL KIT

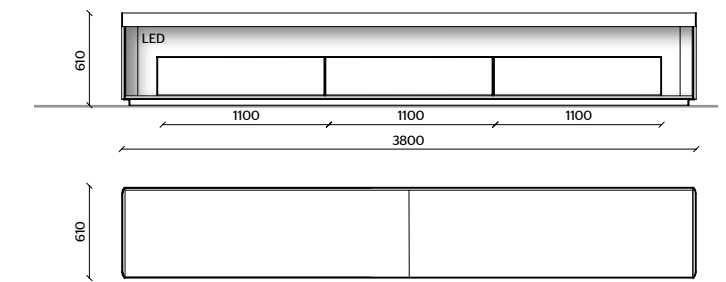
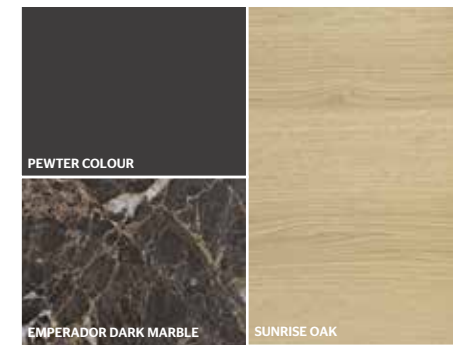





## CLEO

Vincent Van Duysen

## SUTTON

Rodolfo Dordoni

## YOELL

Vincent Van Duysen

**Molteni & C**

# VISUAL INDEX

COMPOSITION 1  
page 50



COMPOSITION 2  
page 52



COMPOSITION 7  
page 62



COMPOSITION 8  
page 64



COMPOSITION 3  
page 54



COMPOSITION 4  
page 56



COMPOSITION 9  
page 66



COMPOSITION 10  
page 68



COMPOSITION 5  
page 58



COMPOSITION 6  
page 60



COMPOSITION 11  
page 70



Cleo

1

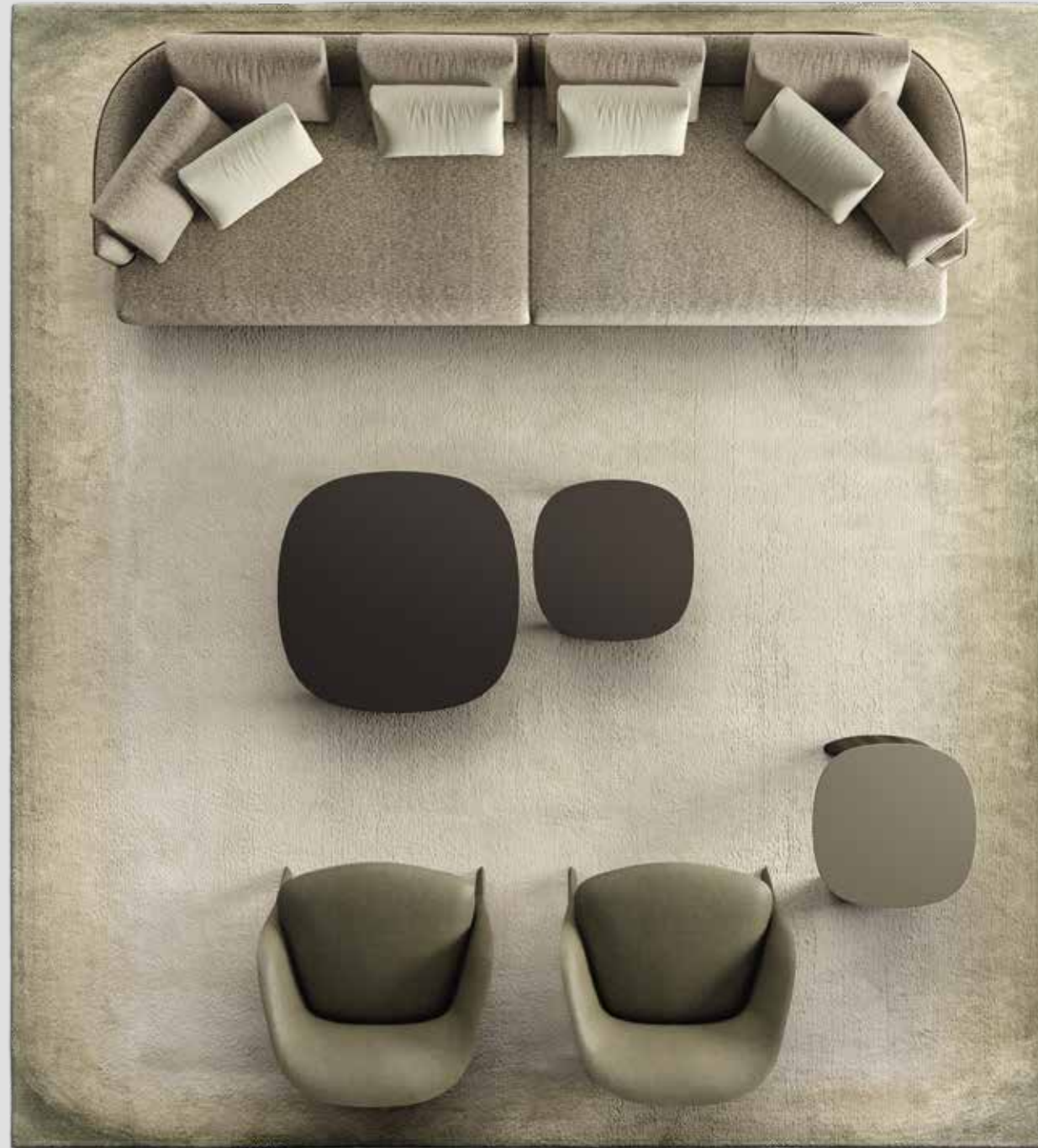

MEASUREMENTS IN CM

**CLEO**



**SEATING SYSTEM**

W 320 D 100 H 67

**EXTERNAL STRUCTURE**  
STR16 SX + STR16 DX  
UNIQUE UE130 LEATHER

**INTERNAL CUSHIONING**  
ITR16 SX + ITR16 DX  
KIWI KH522 FABRIC

**BACK CUSHIONS**  
N.6 CCS55 KIWI KH522 FABRIC  
N.4 CCS45 WOK WH211 FABRIC

**CLEO**



**COFFEE TABLES**

CTV1 W 60 D 60 H 31  
GALAXY PAINTED TOP  
EUCALYPTUS BASE

CTV2 W 60 D 60 H 44  
MINK ECO SKIN TOP  
EUCALYPTUS BASE

CTV3 W 90 D 90 H 31  
GALAXY PAINTED TOP  
EUCALYPTUS BASE

**SUTTON**



**ARMCHAIRS**

N.2 SPO1 W 83 D 84 H 69  
UNIQUE UE146 LEATHER

**EDGE**

**CARPET**

400 X 400 / CUSTOMISED CARPET  
GREEN GRADIENT BORDER COLOUR

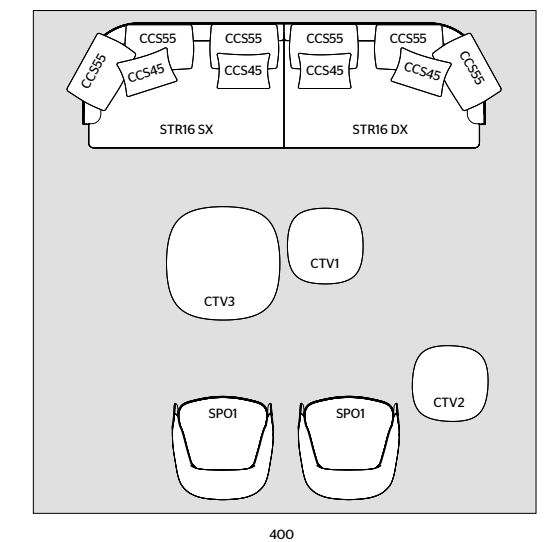

Cleo

2



MEASUREMENTS IN CM

**CLEO**

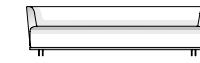

**SEATING SYSTEM**

W 310 D 160 H 67

**EXTERNAL STRUCTURE**  
STR20 SX + SCL16 DX  
UNIQUE UET22 LEATHER

**INTERNAL CUSHIONING**  
ITR20 SX + ICL16 DX  
KUBO KH623 FABRIC

**BACK CUSHIONS**  
CCS75 KUBO KH623 FABRIC  
N4 CCS55 KUBO KH623 FABRIC  
N3 CCS45 KIWI KH520 FABRIC  
CCS45 KALIPSO KH430 FABRIC

**CLEO**



**COFFEE TABLES**

CTV1 W 60 D 60 H 31  
DARK BROWN ECO SKIN TOP  
SUNRISE OAK BASE

CTV4 W 120 D 120 H 31  
GALAXY PAINTED TOP  
SUNRISE OAK BASE

**SUTTON**



**ARMCHAIR**

SPO1 W 83 D 84 H 69  
KIWI KH535 FABRIC  
SIRIA S1232 LEATHER FEET

**PALETTE**

**CARPET**

400 X 400 / CUSTOMISED CARPET  
DOVE GREY COLOUR

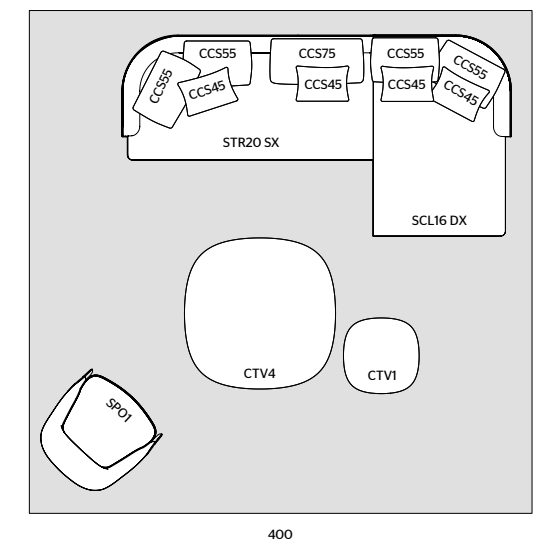

Cleo

3



MEASUREMENTS IN CM

**CLEO**

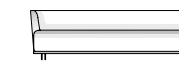

**SEATING SYSTEM**

W 356 D 158 H 67

**EXTERNAL STRUCTURE**  
STR18 SX + SIC20 DX  
EXTRA L159 LEATHER

**INTERNAL CUSHIONING**  
ITR18 SX + IIC20 DX  
KERMESSE KH746 FABRIC

**BACK CUSHIONS**  
CCS75 KERMESSE KH746 FABRIC  
N4 CCS55 KERMESSE KH746 FABRIC  
CCS45 KALIPSO KH430 FABRIC  
N2 CCS45 ZANZIBAR ZH320 FABRIC

**CLEO**



**COFFEE TABLES**

CTV1 W 60 D 60 H 31  
TAUPE ECO SKIN TOP  
BLACK OAK BASE

CTV3 W 90 D 90 H 31  
GALAXY PAINTED TOP  
BLACK OAK BASE

**YOELL**



**ARMCHAIR**

OPO1 W 65 D 84 H 88  
TESSUTO KIWI KH547 FABRIC  
BLACK OAK STRUCTURE

**PALETTE**

**CARPET**

400 X 400 / CUSTOMISED CARPET  
DOVE GREY COLOUR

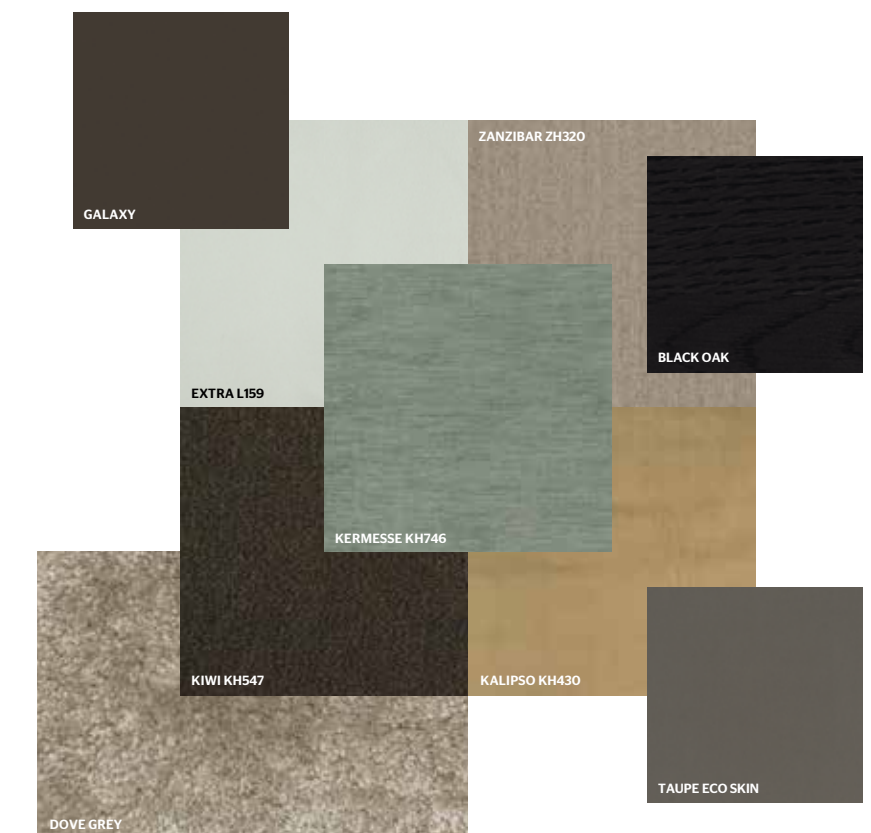
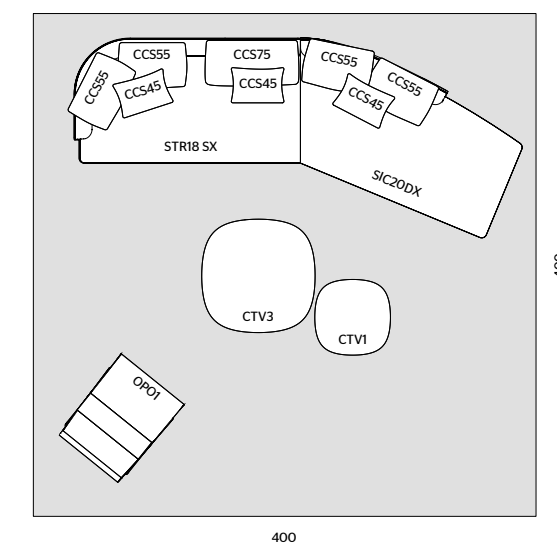



MEASUREMENTS IN CM

**CLEO**

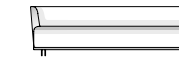

**SEATING SYSTEM**

W 328 D 156 H 67

**EXTERNAL STRUCTURE**  
SCC14 SX + STR18 DX  
UNIQUE UE 146 LEATHER

**INTERNAL CUSHIONING**  
ICC14 SX + ITR18 DX  
WOK WH220 FABRIC

**BACK CUSHIONS**  
CCS75 WOK WH220 FABRIC  
N5 CCS55 WOK WH220 FABRIC  
N4 CCS45 KERMESSE KH722 FABRIC

**CLEO**



**COFFEE TABLES**

CTV1 W 60 D 60 H 31  
EARTH ECO SKIN TOP  
EUCALYPTUS BASE

CTV2 W 60 D 60 H 44  
GALAXY PAINTED TOP  
EUCALYPTUS BASE

CTV3 W 90 D 90 H 31  
GALAXY PAINTED TOP  
EUCALYPTUS BASE

**SUTTON**



**ARMCHAIR**

SPO1 W 83 D 84 H 69  
ZANZIBAR ZH343 FABRIC  
SIRIA S1235 LEATHER FEET

**AURA**

**CARPET**

500 X 400 / CUSTOMISED CARPET  
SAGE COLOUR

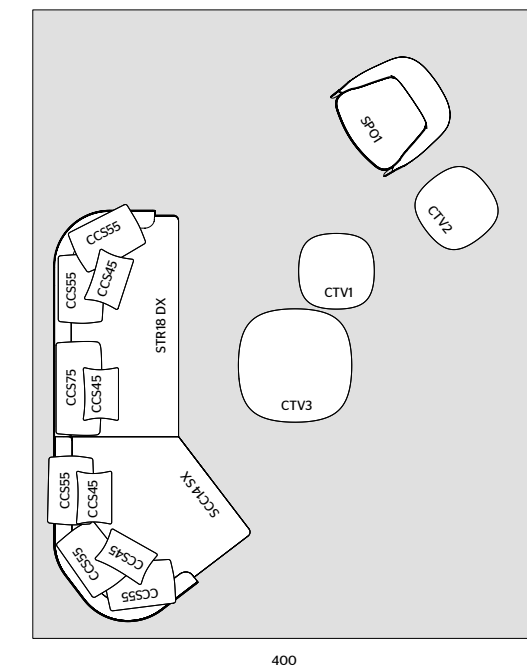



MEASUREMENTS IN CM

**CLEO**



**SEATING SYSTEM**

W 397 D 160 H 67

**EXTERNAL STRUCTURE**  
SCL16 SX + SCE14 + SCC14 DX  
KUBO KH611 FABRIC

**INTERNAL CUSHIONING**  
ICL16 SX + ICE14 + ICC14 DX  
KUBO KH611 FABRIC

**BACK CUSHIONS**  
N.7 CCS55 KUBO KH611 FABRIC  
N.6 CCS45 KAOMA ZH126 FABRIC

**CLEO**



**COFFEE TABLES**

CTV1 W 60 D 60 H 31  
IVORY ECO SKIN TOP  
EUCALYPTUS BASE

CTV2 W 60 D 60 H 44  
GALAXY PAINTED TOP  
EUCALYPTUS BASE

CTV3 W 90 D 90 H 31  
IVORY ECO SKIN TOP  
EUCALYPTUS BASE

**YOELL**



**ARMCHAIR**

OPO1 W 65 D 84 H 88  
SCIROCCO SD930 LEATHER  
SUNRISE OAK STRUCTURE

**PALETTE**

**CARPET**

450 X 400 / CUSTOMISED CARPET  
DOVE GREY COLOUR

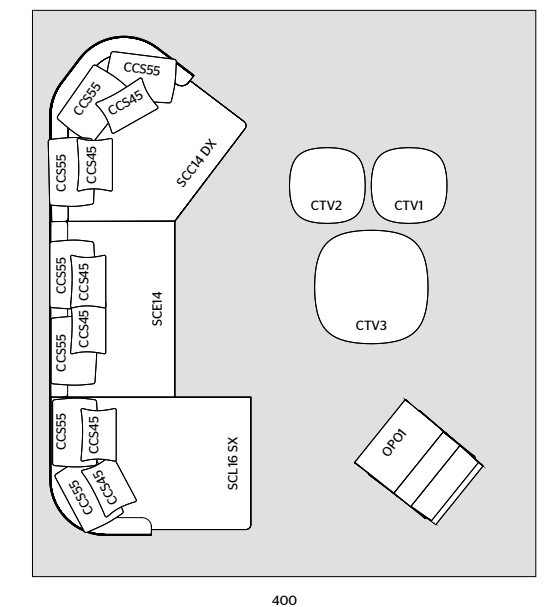

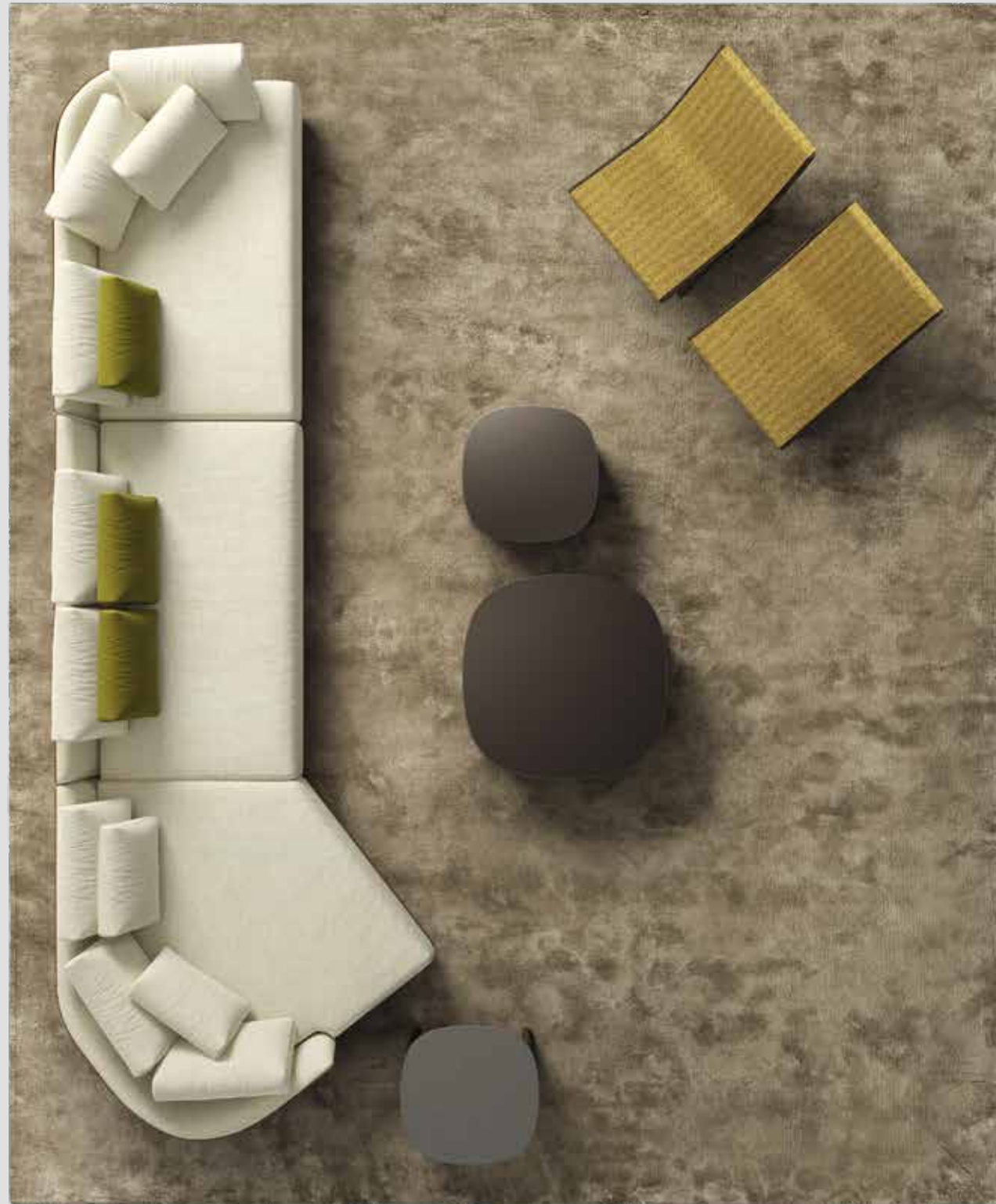

MEASUREMENTS IN CM

**CLEO**

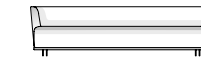

**SEATING SYSTEM**

W 447 D 156 H 67

**EXTERNAL STRUCTURE**  
SCC14 SX + SCE14 + STR16 DX  
SIRIA S1254 LEATHER

**INTERNAL CUSHIONING**  
ICC14 SX + ICE14 + ITR16 DX  
KERMESSE KH713 FABRIC

**BACK CUSHIONS**  
N.8 CCS55 KERMESSE KH713 FABRIC  
N.3 CCS45 KERMESSE KH713 FABRIC  
N.3 CCS45 WOK WH245 FABRIC

**CLEO**



**COFFEE TABLES**

CTV1 W 60 D 60 H 31  
GALAXY PAINTED TOP  
EUCALYPTUS BASE

CTV2 W 60 D 60 H 44  
TAUPE ECO SKIN TOP  
EUCALYPTUS BASE

CTV3 W 90 D 90 H 31  
GALAXY PAINTED TOP  
EUCALYPTUS BASE

**YOELL**



**ARMCHAIRS**

N.2 OPO1 W 65 D 84 H 88  
ZANZIBAR ZH351 FABRIC  
EUCALYPTUS STRUCTURE

**PALETTE**

**CARPET**

500 X 400 / CUSTOMISED CARPET  
TAUPE COLOUR

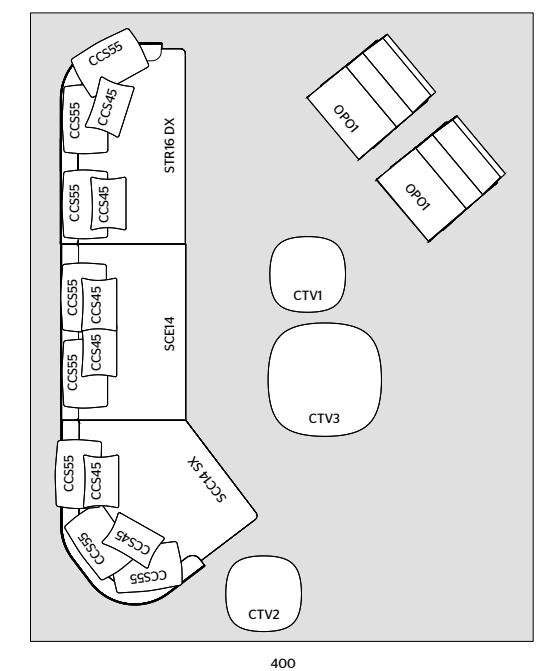





MEASUREMENTS IN CM

<b>CLEO</b>	<b>SEATING SYSTEM</b>
	W 461 D 158 H 67 <b>EXTERNAL STRUCTURE</b> SIC20 SX + SCE14 + SCC14 DX SIRIA S1221 LEATHER <b>INTERNAL CUSHIONING</b> IIC20 SX + ICE14 + ICC14 DX WOK WH243 FABRIC <b>BACK CUSHIONS</b> N.7 CCS55 WOK WH243 FABRIC N.5 CCS45 KAOMA KH142 FABRIC
<b>CLEO</b>	<b>COFFEE TABLES</b>
	CTV1 W 60 D 60 H 31 MINK ECO SKIN TOP SUNRISE OAK BASE  CTV2 W 60 D 60 H 44 IVORY ECO SKIN TOP SUNRISE OAK BASE  CTV4 W 120 D 120 H 31 GALAXY PAINTED TOP SUNRISE OAK BASE
<b>SUTTON</b>	<b>ARMCHAIR</b>
	SPO1 W 83 D 84 H 69 SCIROCCO SD930 LEATHER
<b>DEDALO</b>	<b>CARPET</b>
	550 X 400 / CUSTOMISED CARPET SOFT GREY COLOUR

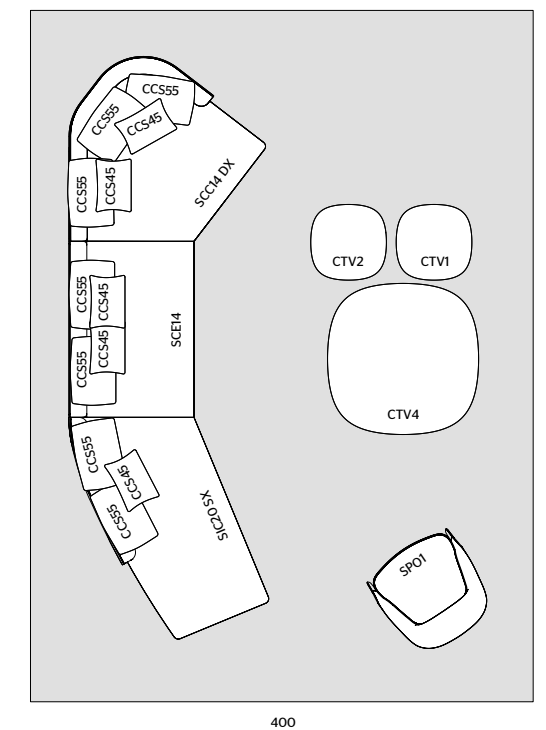



MEASUREMENTS IN CM

**CLEO**

**SEATING SYSTEM**



W 345 D 388 H 67

**EXTERNAL STRUCTURE**

STR16 SX + SAN18 SX + SCE14 + SCC14 DX  
KERMESSE KH713 FABRIC

**INTERNAL CUSHIONING**

ITR16 SX + IAN18 SX + ICE14 + ICC14 DX  
KERMESSE KH713 FABRIC

**BACK CUSHIONS**

N1 CCS75 KERMESSE KH713 FABRIC  
N11 CCS55 KERMESSE KH713 FABRIC  
N2 CCS45 KALIPSO KH430 FABRIC  
N6 CCS45 KERMESSE KH713 FABRIC

**CLEO**

**COFFEE TABLES**



N2 CTV2 W 60 D 60 H 44  
GALAXY PAINTED TOP  
SUNRISE OAK BASE

CTV3 W 90 D 90 H 31  
IVORY ECO SKIN TOP  
SUNRISE OAK BASE

CTV4 W 120 D 120 H 31  
GALAXY PAINTED TOP  
SUNRISE OAK BASE

**YOELL**

**ARMCHAIRS**



N2 OPO1 W 65 D 84 H 88  
SIRIA S1254 LEATHER  
SUNRISE OAK STRUCTURE

**STRIPE**

**CARPET**

540 X 450 / CUSTOMISED CARPET  
COLORE CREAM GREY COLOUR

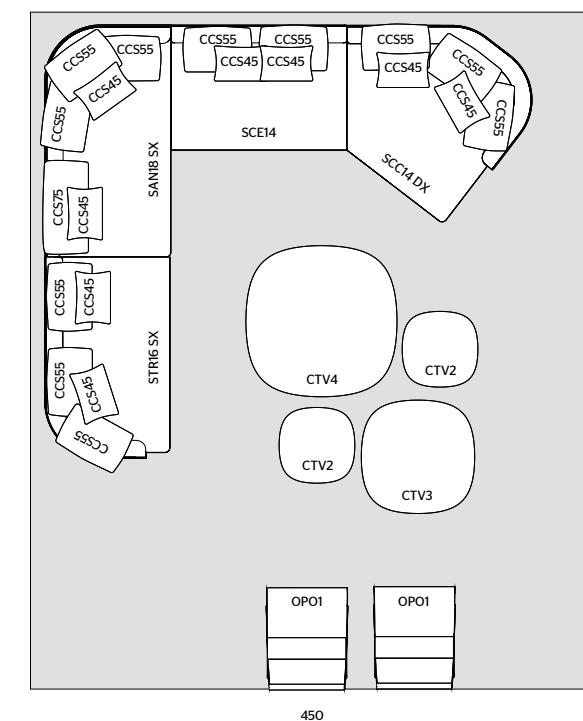



MEASUREMENTS IN CM

**CLEO**



**SEATING SYSTEM**

W 434 D 300 H 67

**EXTERNAL STRUCTURE**

STR20 SX + SAN18 DX + SCE14 + SCL16DX  
UNIQUE UE146 LEATHER

**INTERNAL CUSHIONING**

ITR20 SX + IAN18 DX + ICE14 + ICL16 DX  
KUBO KH621 FABRIC

**BACK CUSHIONS**

N.2 CCS75 KUBO KH621 FABRIC  
N.8 CCS55 KUBO KH621 FABRIC  
N.2 CCS45 UNIQUE UE146 LEATHER  
N.6 CCS45 KERMESSE KH711 FABRIC

**YOELL**



**ARMCHAIRS**

N.2 OPO1 W 65 D 84 H 88  
WOK WH235 FABRIC  
BLACK OAK STRUCTURE

**SUTTON**



**ARMCHAIR**

SPO1 W 83 D 84 H 69  
KERMESSE KH773 FABRIC  
UNIQUE UE146 LEATHER FEET

**EDGE**

**CARPET**

550 X 500 / CUSTOMISED CARPET  
GREEN GRADIENT BORDER COLOUR

**CLEO**



**COFFEE TABLES**

CTV1 W 60 D 60 H 31  
MINK ECO SKIN TOP  
BLACK OAK BASE

N.2 CTV2 W 60 D 60 H 44  
GALAXY PAINTED TOP  
BLACK OAK BASE

CTV4 W 120 D 120 H 31  
MINK ECO SKIN TOP  
BLACK OAK BASE

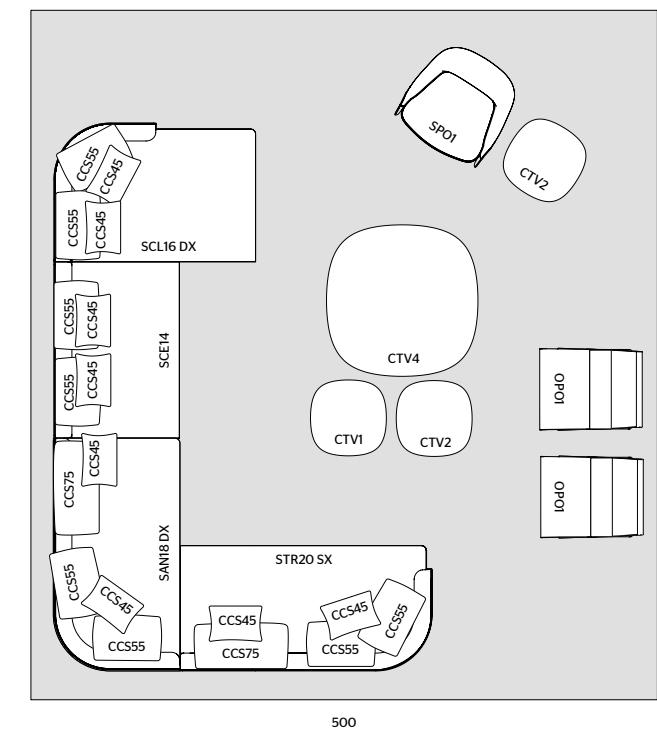

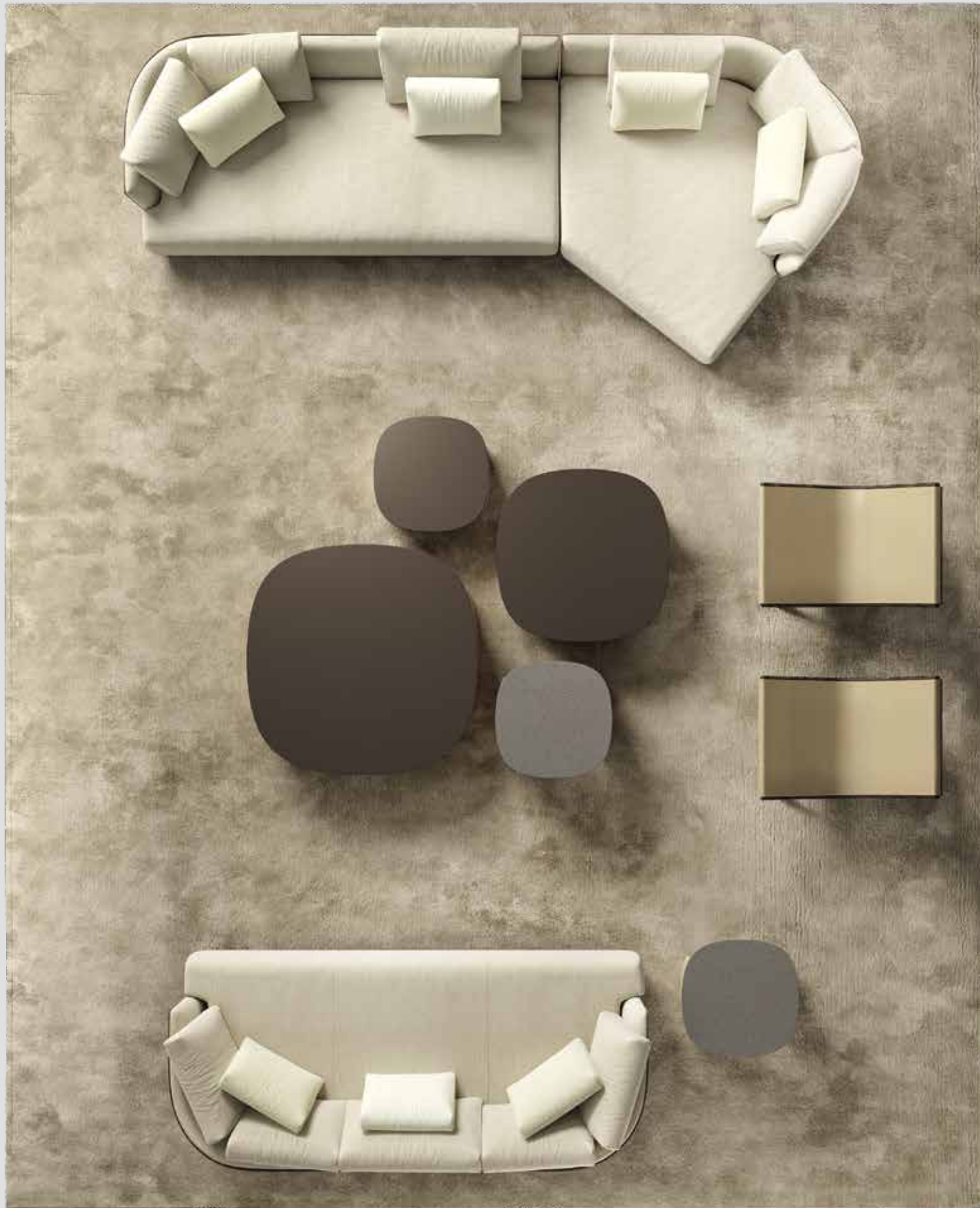

MEASUREMENTS IN CM

**CLEO**

**SEATING SYSTEM**



W 240 D 100 H 67

**EXTERNAL STRUCTURE**

SDI24  
UNIQUE UE130 LEATHER

**INTERNAL CUSHIONING**

IDI24  
KUBO KH612 FABRIC

**BACK CUSHIONS**

CCS75 KUBO KH612 FABRIC  
N4 CCS55 KUBO KH612 FABRIC  
CCS45 KALIPSO KH 411 FABRIC  
N2 CCS45 WOK WH211 FABRIC

**CLEO**

**SEATING SYSTEM**

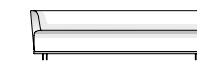

W 348 D 158 H 67

**EXTERNAL STRUCTURE**

STR20 SX + SCC14 DX  
UNIQUE UE130 LEATHER

**INTERNAL CUSHIONING**

ITR20 SX + ICC14 DX  
KUBO KH612 FABRIC

**BACK CUSHIONS**

CCS75 KUBO KH612 FABRIC  
N5 CCS55 KUBO KH612 FABRIC  
CCS45 KALIPSO KH 411 FABRIC  
N3 CCS45 WOK WH211 FABRIC

**CLEO**

**COFFEE TABLES**



CTV1 W 60 D 60 H 31  
GALAXY PAINTED TOP  
SUNRISE OAK BASE

N2 CTV2 W 60 D 60 H 44  
TAUPE ECO SKIN TOP  
SUNRISE OAK BASE

CTV3 W 90 D 90 H 31  
GALAXY PAINTED TOP  
SUNRISE OAK BASE

CTV4 W 120 D 120 H 31  
GALAXY PAINTED TOP  
SUNRISE OAK BASE

**YOELL**

**ARMCHAIRS**



N2 OPO1 W 65 D 84 H 88  
SIRIA S1220 LEATHER  
EUCALYPTUS SRUCTURE

**PALETTE**

**CARPET**

600 X 500 / CUSTOMISED CARPET  
DOVE GREY COLOUR

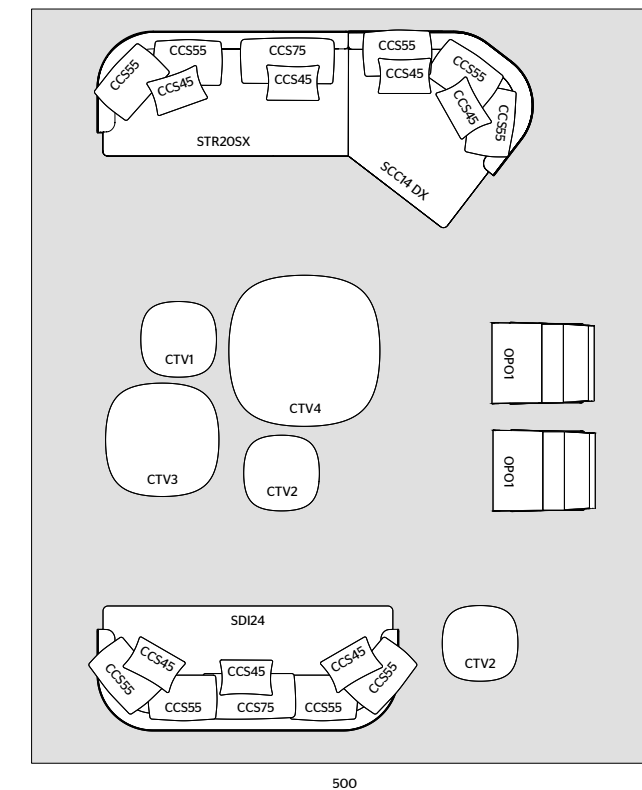



MEASUREMENTS IN CM

**CLEO**



**SEATING SYSTEM**

N.2 – W 350 D 156 H 67  
**EXTERNAL STRUCTURE**  
 STC20 SX + STC20 DX  
 UNIQUE UE122 LEATHER

**INTERNAL CUSHIONING**  
 ITC20 SX + ITC20 DX  
 KIWI KH513 FABRIC

**BACK CUSHIONS**  
 N.2 CCS75 KIWI KH513 FABRIC  
 N.4 CCS55 KIWI KH513 FABRIC  
 CCS45 KERMESSE KH746 FABRIC  
 CCS45 KALIPSO KH411 FABRIC  
 N.2 CCS45 KIWI KH513 FABRIC

**CLEO**



**COFFEE TABLES**

CTV1 W 60 D 60 H 31  
 GALAXY PAINTED TOP  
 EUCALYPTUS BASE

N.2 CTV2 W 60 D 60 H 44  
 DARK BROWN ECO SKIN TOP  
 EUCALYPTUS BASE

CTV3 W 90 D 90 H 31  
 GALAXY PAINTED TOP  
 EUCALYPTUS BASE

**YOELL**



**ARMCHAIR**

OPO1 W 65 D 84 H 88  
 SIRIA S1235 LEATHER  
 EUCALYPTUS STRUCTURE

**SUTTON**



**ARMCHAIRS**

N.2 SPO1 W 83 D 84 H 69  
 KERMESSE KH746 FABRIC  
 UNIQUE UE121 LEATHER FEET

**VIBRAZIONI**

**CARPET**

650 X 500 / CUSTOMISED CARPET  
 ICE COLOUR

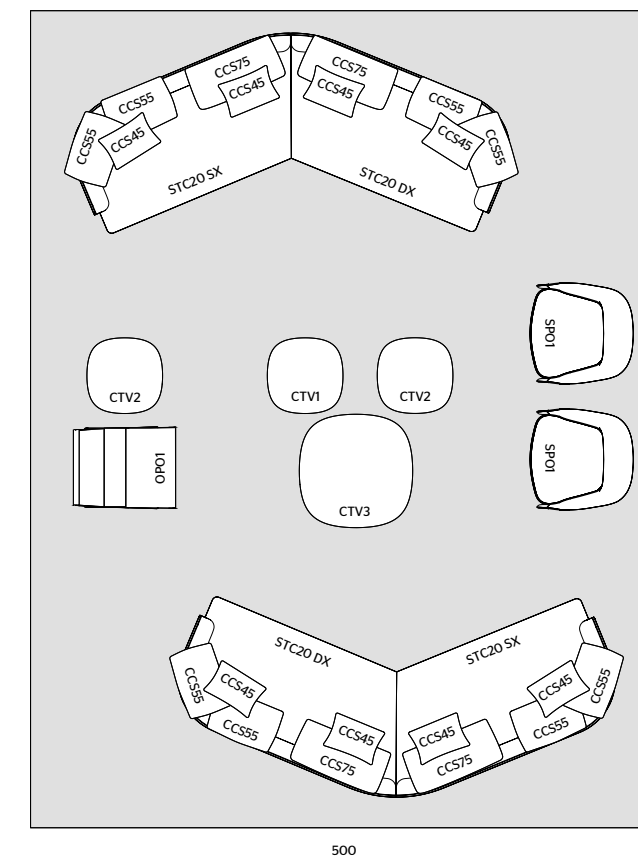

## **BLEVIO**

Ignazio Gardella

## **JANET**

Vincent Van Duysen



**Molteni & C**

# VISUAL INDEX

COMPOSITION 1

page 77



COMPOSITION 2

page 78



COMPOSITION 3

page 79





**BLEVIO**



**TABLE**

BT32/10  
 W 320 D 105 H 74  
 ECLIPSE SINGLE-MATERIAL

**JANET**



**CHAIRS**

N.3 JSE1  
 W 49,5 D 60 H 81  
 ZANZIBAR ZH320 FABRIC  
 SUNRISE OAK STRUCTURE

**STRIPE**

MEASUREMENTS IN CM

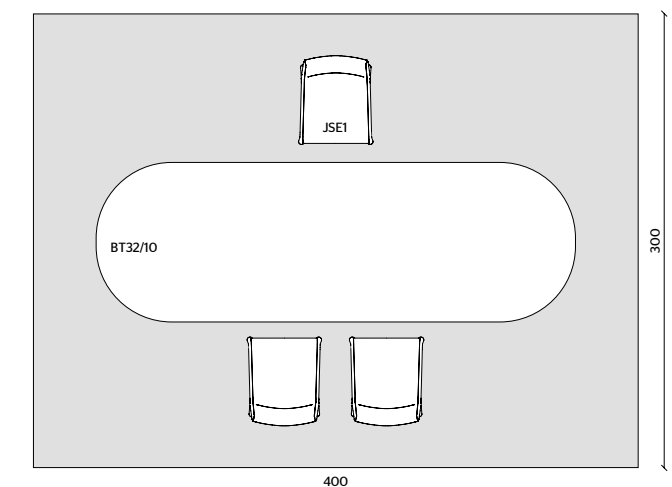

**CARPET**

TASTO3  
 400 X 300  
 CREAM GREY COLOUR





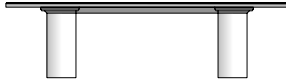

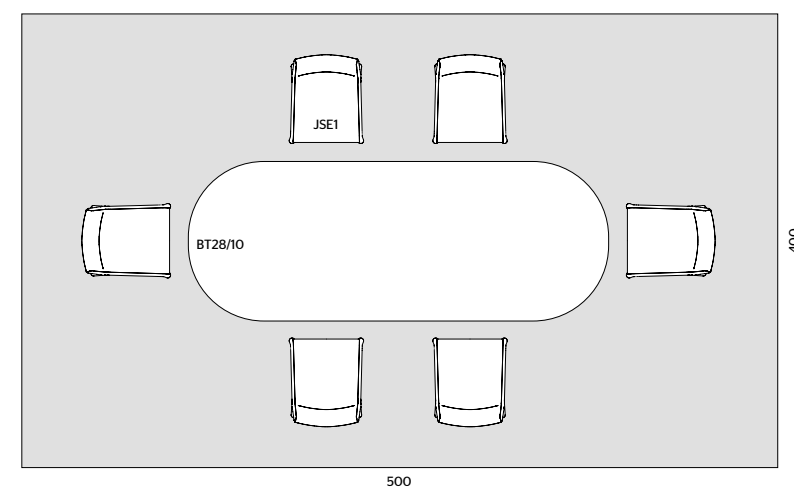

<b>BLEVIO</b>	<b>TABLE</b>
	BT28/10 W 280 D 105 H 74 ECLIPSE STRUCTURE BRECCIA CAPRAIA MARBLE TOP
<b>JANET</b>	<b>CHAIRS</b>
	N.6 JSE1 W 49,5 D 60 H 81 KIWI KH522 FABRIC BLACK OAK STRUCTURE
<b>VIBRAZIONI</b>	<b>CARPET</b>
MEASUREMENTS IN CM	TAVIO4 500 X 400 ICE COLOUR

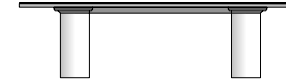

<b>BLEVIO</b>	<b>TABLE</b>
	BT32/10 W 320 D 105 H 74 ECLIPSE SINGLE-MATERIAL
<b>JANET</b>	<b>CHAIRS WITH ARMS</b>
	N.8 JSB1 W 53,5 D 60 H 81 SIRIA S1254 LEATHER EUCALYPTUS STRUCTURE
<b>PALETTE</b>	<b>CARPET</b>
MEASUREMENTS IN CM	TAPA03 500 X 300 TAUPE COLOUR

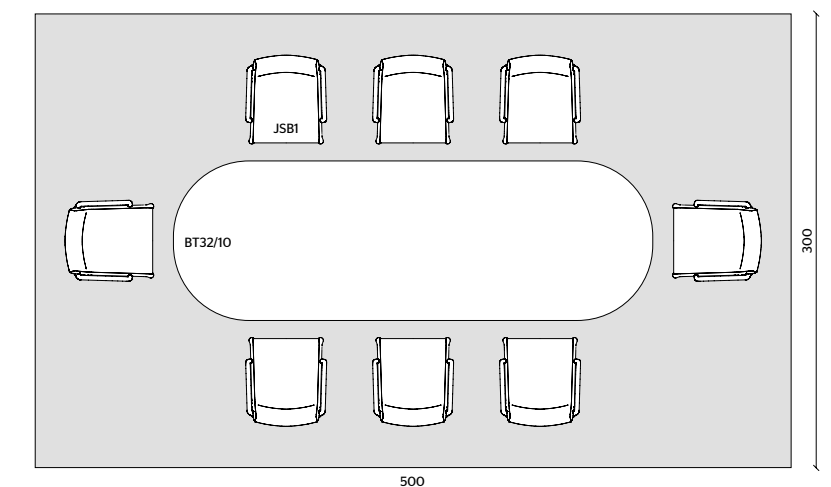



# GLISS MASTER

Vincent Van Duysen

Molteni & C

# VISUAL INDEX

COMPOSITION 1

page 84



COMPOSITION 2

page 86



COMPOSITION 3

page 88



COMPOSITION 4

page 90



# Gliss Master



## WARDROBE WITHOUT DOORS

### STRUCTURE

DARK CHESTNUT

### GLASS CENTRAL PARTITIONS

EARTH ECO SKIN INSERT  
PEWTER COLOUR FRAME /  
TRANSPARENT GLASS

### SHELVES

EARTH ECO SKIN INSERT  
PEWTER COLOUR PROFILE

### CLOTHES RAILS

EARTH ECO SKIN

### PULL-OUT FRAMES

EARTH ECO SKIN BOTTOM  
WITH AND WITHOUT INTERNAL GRID

### PULL-OUT FRAMES WITH SACK

EARTH ECO SKIN  
PEWTER COLOUR FRAME

### TROUSER HOLDER

PULL-OUT FRAMES  
PEWTER COLOUR

LED LIGHTING BARS,  
RADIO CONTROL KIT

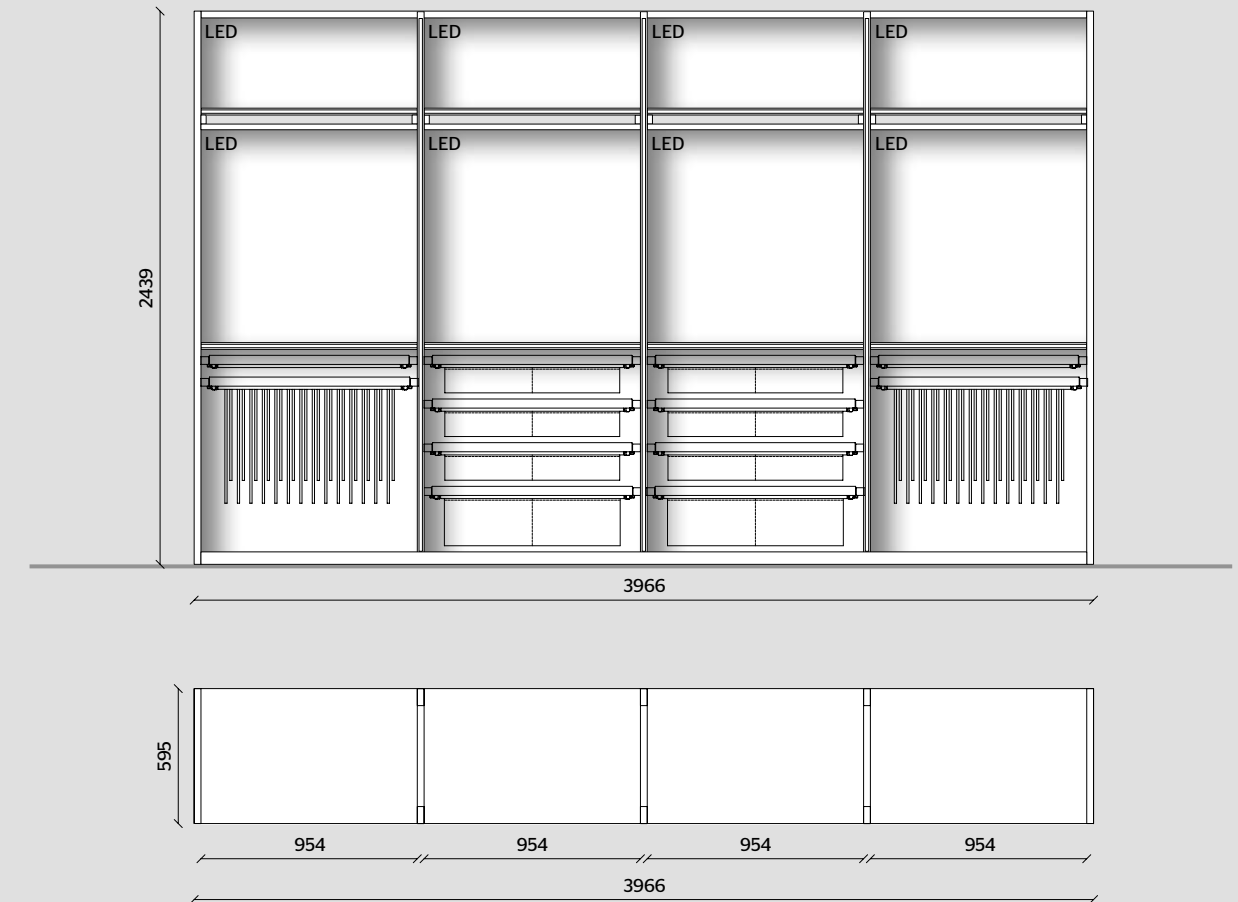
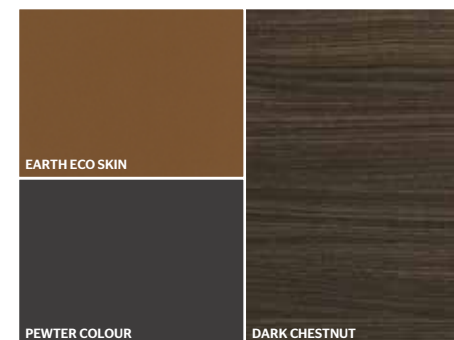

# Gliss Master

2



## WARDROBE WITH DOORS

**"FIND ME" HINGED DOORS**  
LUNAR

**STRUCTURE, SHELVES,  
SHOE RACK SHELF**  
LIGHT CHESTNUT

**CLOTHES RAILS**  
PEWTER COLOUR

**PULL-OUT FRAME**  
HEMP ECO SKIN BOTTOM  
WITH INTERNAL GRID

**PULL-OUT FRAME WITH SACK**  
HEMP ECO SKIN  
PEWTER COLOUR FRAME

**TROUSER HOLDER**  
**PULL-OUT FRAME**  
PEWTER COLOUR

**LED LIGHTING BARS**  
WITH SENSOR

## WARDROBE WITHOUT DOORS

**STRUCTURE**  
LIGHT CHESTNUT

**GLASS CENTRAL PARTITIONS**  
HEMP ECO SKIN INSERT  
PEWTER COLOUR FRAME /  
TRANSPARENT GLASS

**SHELVES**  
HEMP ECO SKIN INSERT  
PEWTER COLOUR PROFILE

**CLOTHES RAILS**  
HEMP ECO SKIN

**PULL-OUT FRAMES**  
HEMP ECO SKIN BOTTOM  
WITH AND WITHOUT INTERNAL GRID

**PULL-OUT FRAMES WITH SACK**  
HEMP ECO SKIN  
PEWTER COLOUR FRAME

**LED LIGHTING BARS,  
RADIO CONTROL KIT**

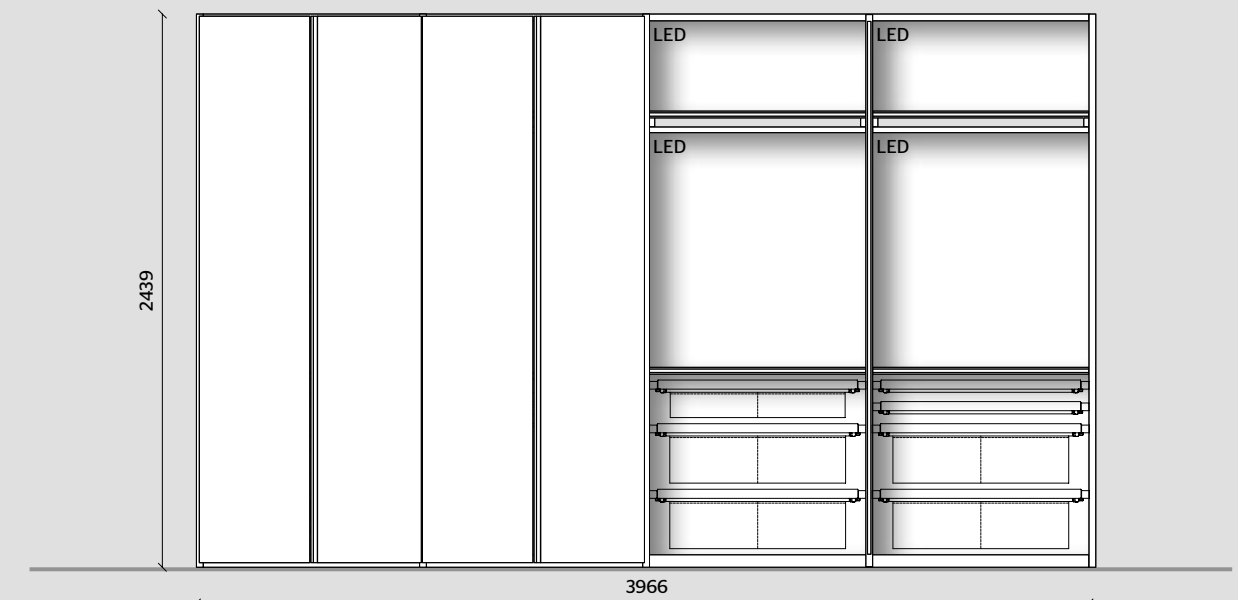
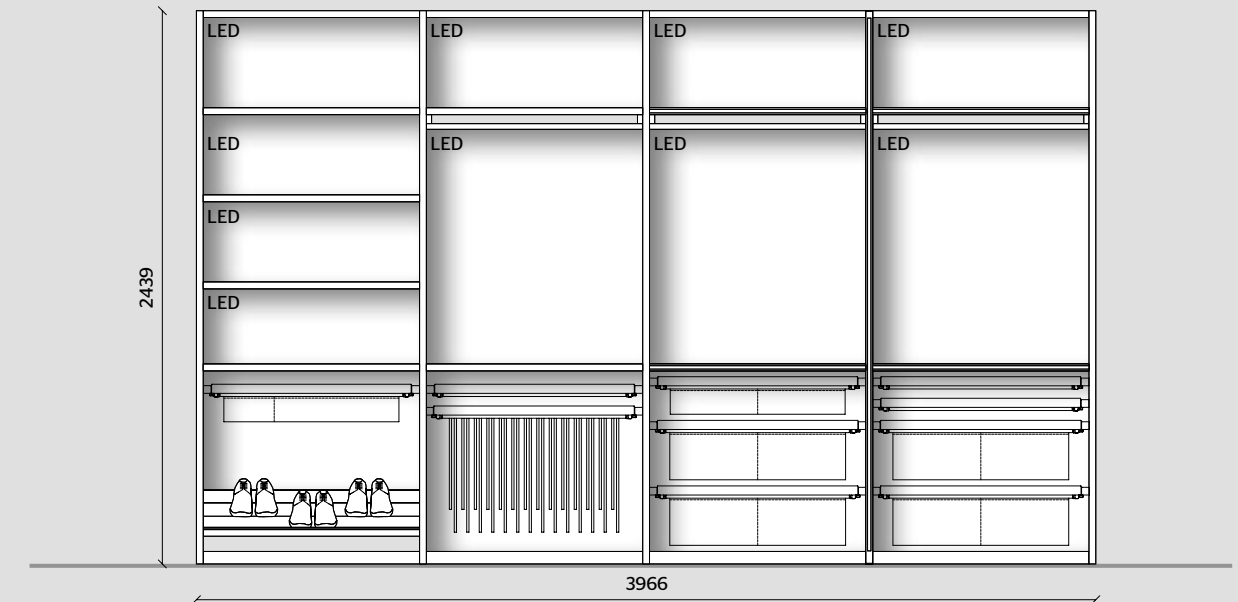
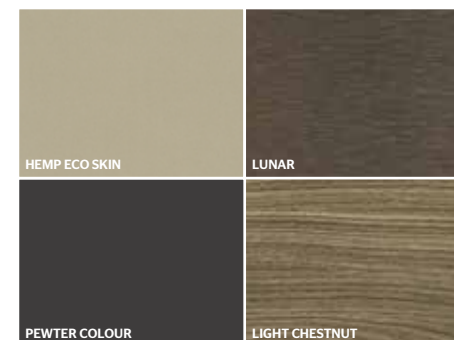

# Gliss Master

3



## WARDROBE WITH DOORS

**"SMOOTH" HINGED DOORS**  
EARTH ECO SKIN,  
PEWTER COLOUR HANDLE AND  
PERIMETER PROFILES

**STRUCTURE, SHELVES**  
LIGHT CHESTNUT

**CLOTHES RAILS**  
EARTH ECO SKIN

**DRAWERS, TROUSER HOLDERS TRAY**  
LIGHT CHESTNUT,  
PEWTER COLOUR "HOLD" HANDLE

**LED LIGHTING BARS**  
WITH SENSOR

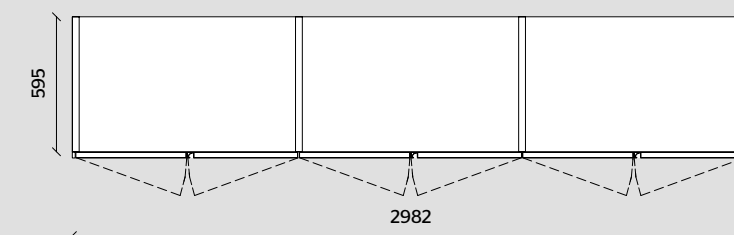
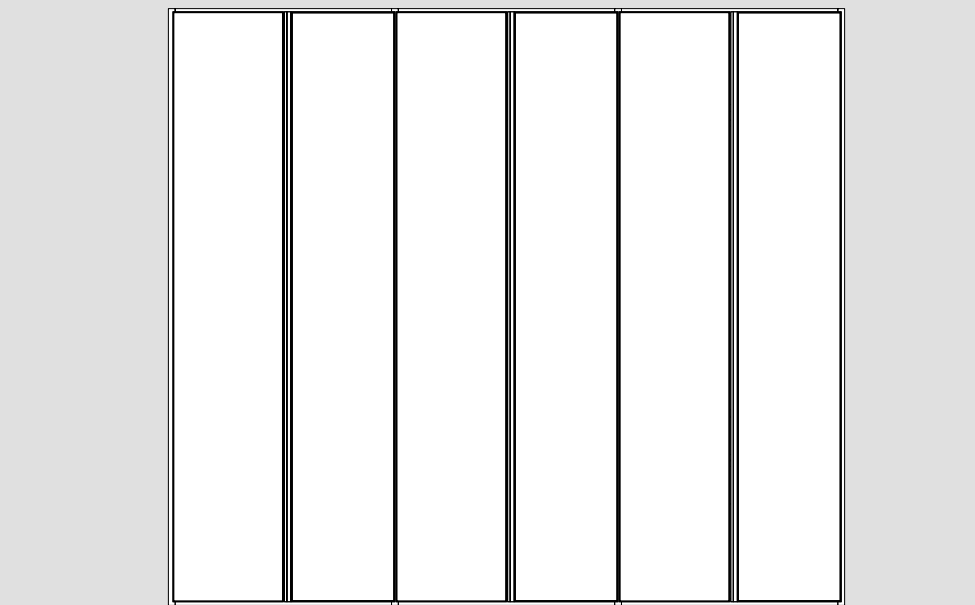
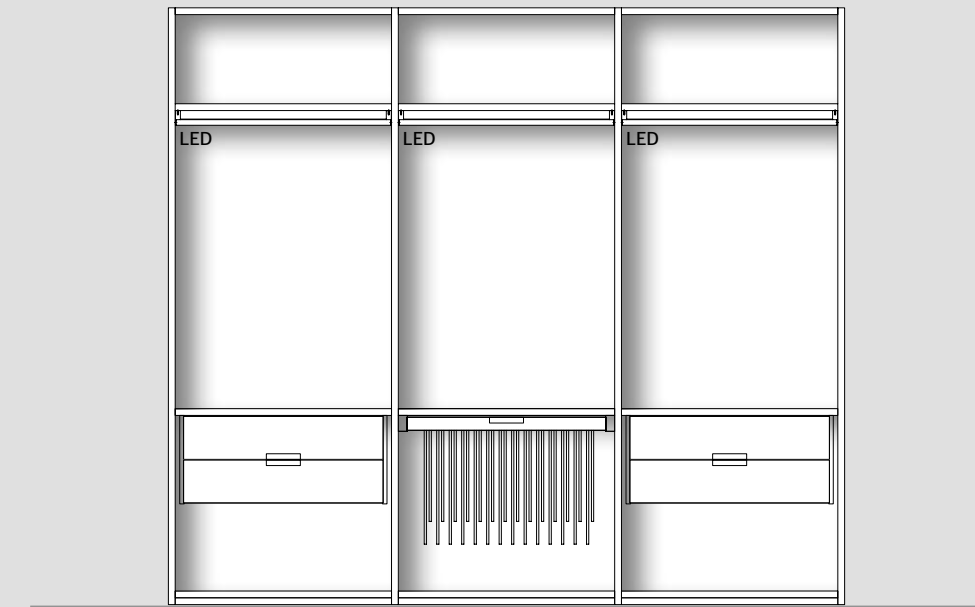
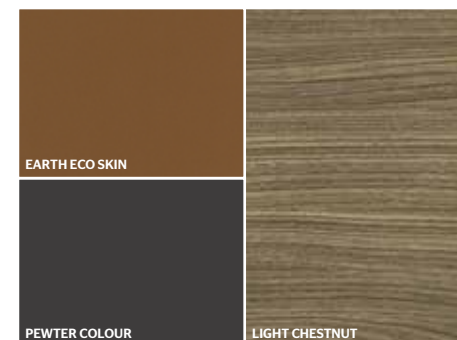

# Gliss Master

4



## WARDROBE WITH DOORS

**"GLASS" HINGED DOORS**  
 TRANSPARENT STOPSOL,  
 PEWTER COLOUR HANDLE AND  
 PERIMETER PROFILES

**STRUCTURE**  
 DARK CHESTNUT

**SIDE PANELS**  
 TRANSPARENT STOPSOL,  
 PEWTER COLOUR  
 PERIMETER FRAMES

**CENTRAL PARTITION**  
 PEWTER COLOUR FRAME

**CLOTHES RAILS**  
 TAUPE ECO SKIN

**PULL-OUT FRAMES WITH SACK**  
 TAUPE ECO SKIN  
 PEWTER COLOUR FRAME

**LED LIGHTING BARS**  
 WITH SENSOR

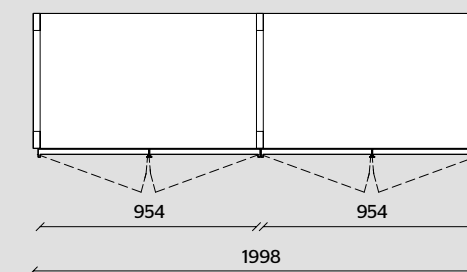
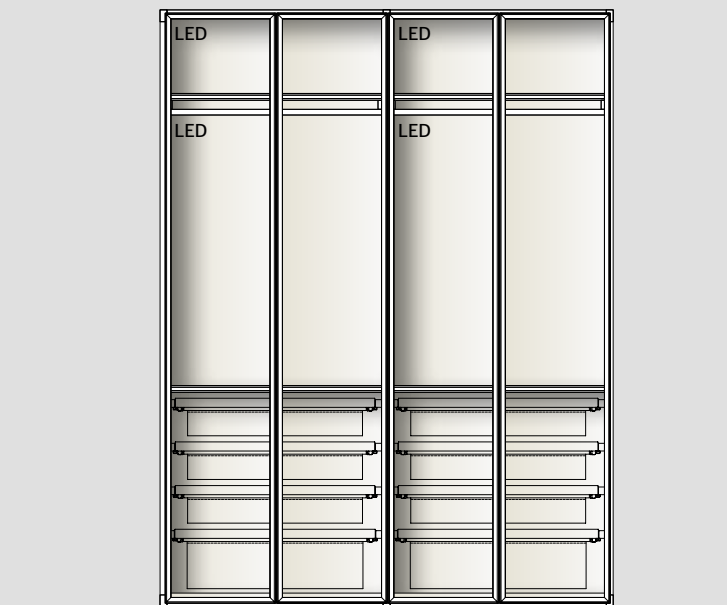
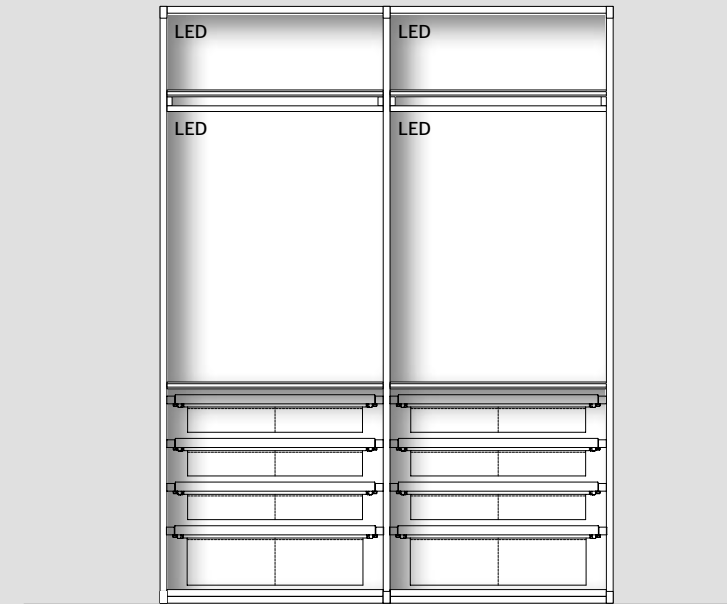



## **ALDGATE**

Rodolfo Dordoni

## **7070**

Rodolfo Dordoni

**Molteni & C**



# VISUAL INDEX

COMPOSITION 1

page 96



COMPOSITION 2

page 98



1



MEASUREMENTS IN CM

**ALDGATE** **BED**

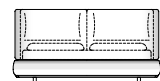

ALT17  
W 190 D 238 H 97 outer dimensions

**BED SURROUND**  
KIWI KH530 FABRIC

**GROSGRAIN**  
DARK BROWN COLOUR

**PAIR OF HEADBOARD CUSHIONS**  
SIRIA S1221 LEATHER

**ALDGATE** **BENCH**



CPN1  
W 163 D 53 H 36  
KIWI KH530 FABRIC  
BLACK NICKEL FEET

**7070** **DRAWER UNITS**



SCD1  
NIGHT TABLE W 60 D 50,2 H 42,4  
SPICE MATT LACQUER  
GLOSSY EUCALYPTUS TOP

SCD2  
NIGHT TABLE WITH PULL-OUT TRAY  
W 60 H D 50,2 H 51,1  
PLATINUM MATT LACQUER  
EUCALYPTUS TRAY  
WITH BOTTOM IN DARK BROWN ECO SKIN

**PALETTE** **CARPET**

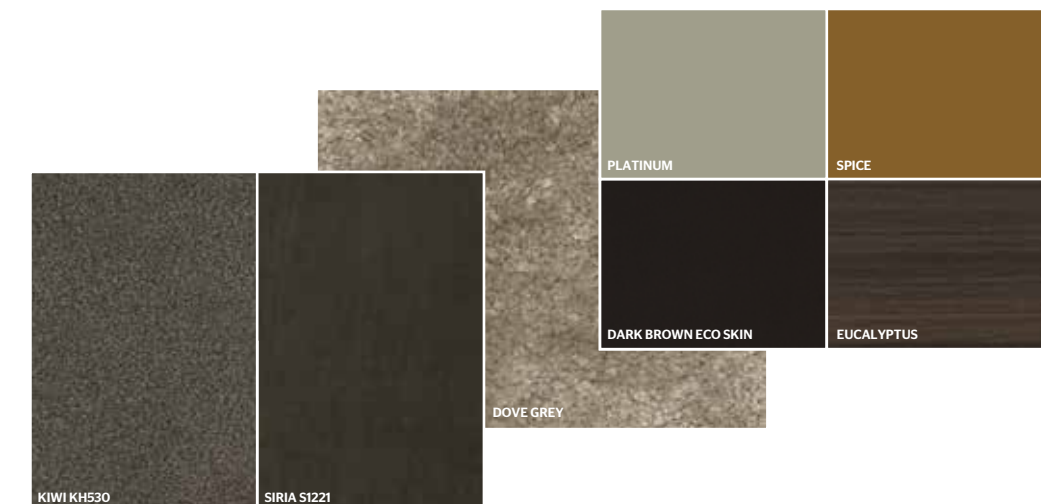
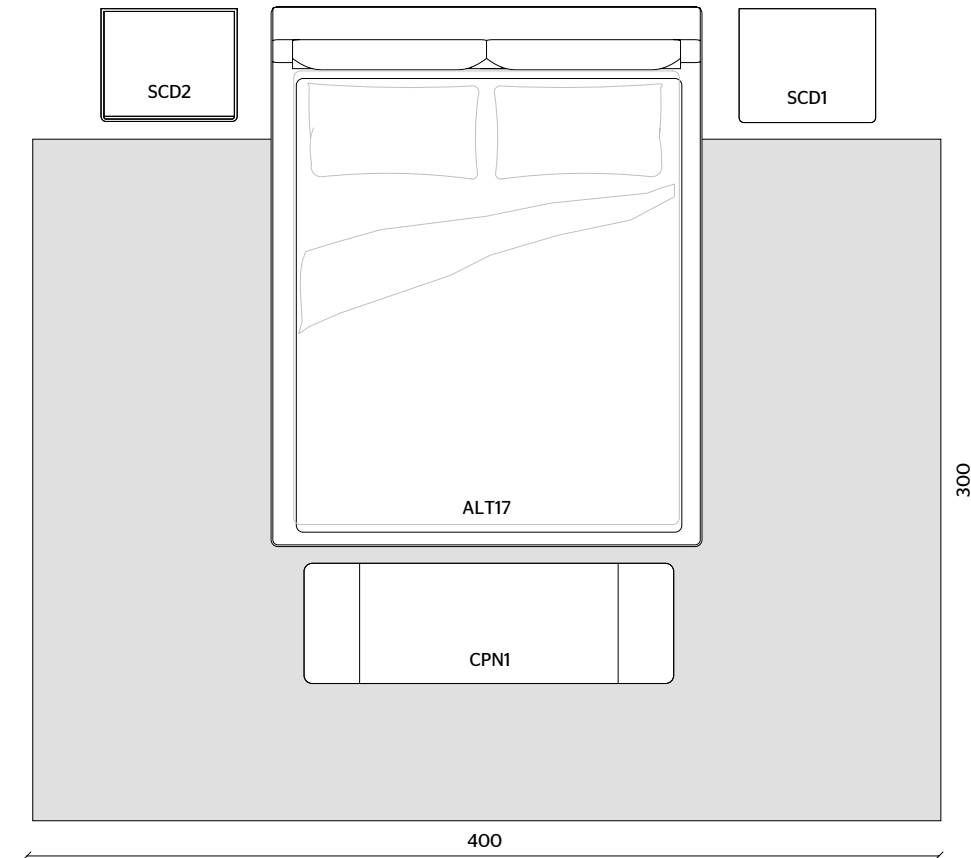

TAPAO2  
400 X 300  
DOVE GREY COLOUR

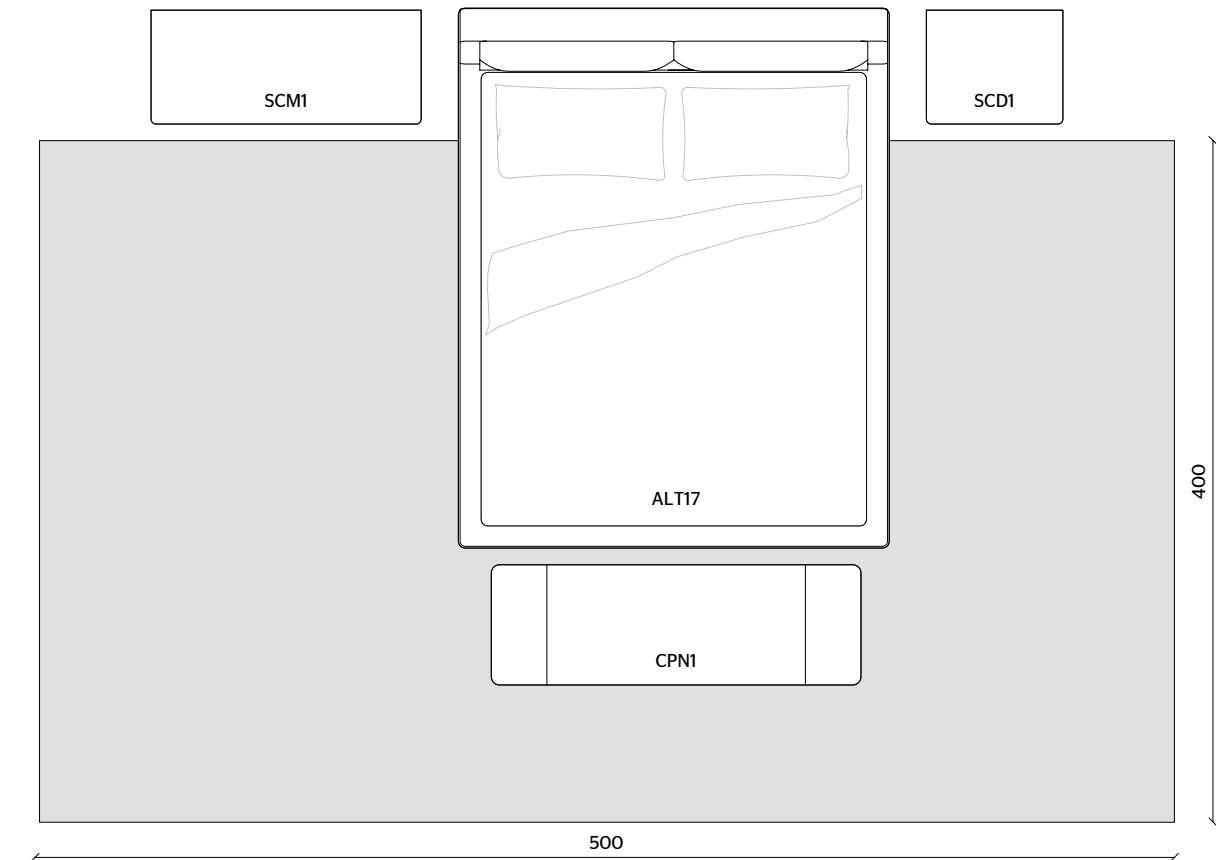

2

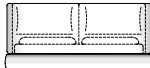

MEASUREMENTS IN CM

<p><b>ALDGATE</b></p> 	<p><b>BED</b></p> <p>ALT 17 W 190 D 238 H 97 outer dimensions</p> <p><b>BED SURROUND</b> UNIQUE UE122 LEATHER</p> <p><b>GROSGRAIN</b> DARK BROWN COLOUR</p> <p><b>PAIR OF HEADBOARD CUSHIONS</b> WOK WH220 FABRIC</p>	<p><b>7070</b></p> 	<p><b>DRAWER UNITS</b></p> <p>SCD1 NIGHT TABLE W 60 D 50,2 H 42,4 PEWTER COLOUR MATT LACQUER MATT EUCALYPTUS TOP</p> <p>SCM1 CHEST OF DRAWERS W 119 H D 50,2 H 61,7 SPICE MATT LACQUER MATT EUCALYPTUS TOP</p>
<p><b>ALDGATE</b></p> 	<p><b>BENCH</b></p> <p>CPN1 W 163 D 53 H 36 UNIQUE UE122 LEATHER BLACK NICKEL FEET</p>	<p><b>STRIPE</b></p>	<p><b>CARPET</b></p> <p>TASTO4 500 X 400 CREAM GREY COLOUR</p>



PHOTO—  
MAX ZAMBELLI



MADE  
IN  
ITALY



moltenigroup.com  
moltenimuseum.com  
#MolteniGroup  
#MolteniMuseum



@MolteniandC



Molteni&C



@MolteniandC



@MolteniandC



@MolteniandC



@MolteniandC



Molteni&C



MolteniC



@MolteniandC

■▼■ **MOLTENIGROUP**

**ONLINE STORE** for US market  
Molteni&C selected pieces  
available also at [shop.molteni.it](https://shop.molteni.it)

DESIGN SOLUTIONS 2022