

Molteni & C

GRID — VINCENT VAN DUYSSEN 2018

1—
16



Grid is a study on the evolution of domestic space expressed by the system's absolute compositional freedom. The project is open, flexible and functional with an innovative modular grid, which organises the compositional elements and enhances individual functions.

DATASHEET

REGISTERED
DESIGN

IX.2023

moltenigroup.com

Dimensions in millimeters and inches. The right to discontinue and make changes is reserved. This information is based on the latest product information available at the time of printing.

FINISHES

finishes	matt lacquer colours	woods	glossy lacquer colours	transparent glass	transparent stopsol glass	pewter colour / copper	Eco Skin	bonded hide leather	bronze mirror
components									
WALL PANELLING									
panel									
SUPPORT SHELF									
shelf									
TRAY									
shelf									
accessory bottom									
CONTAINER UNDER SUPPORT SHELF OR TRAY									
structure / internal partition									
flap door / drawer front									
BOOKCASE									
shelf									
back									
partitions									
WALL UNIT									
top th 30 mm									
back / central shelf / central partition									
glass door and glass partition	profile								
	glass								
GLASS CABINETS									
back and internal shelves									
glass side / hinged door	profile								
	glass								
base / lid									
SHOWCASE									
structure / support									
mirror									
CHARGING ACCESSORY									
structure									

colours

Matt lacquer

BC chalk white
PE pearl
DN dune
PL platinum
NE black
AT anthracite
SE mustard
SI silica
DO dolomite grey
AL clay
MK moka
CZ light blue grey
SA sand
RU ruby
PX pewter colour
RX copper
TO dove grey
PR petroleum blue
BG burgundy
LS london sky
SU stardust
ML moonlight
SP spice
PG pine green
AW almond white

Glossy lacquer

BC chalk white
PE pearl
DN dune
PL platinum
NE black
AT anthracite
SE mustard
SI silica
DO dolomite grey
AL clay
MK moka
CZ light blue grey
SA sand
RU ruby
PX pewter colour
RX copper
TO dove grey
PR petroleum blue
BG burgundy
LS london sky
SU stardust
ML moonlight
SP spice
PG pine green
AW almond white

Woods

EU eucalyptus
RF graphite oak

Eco Skin

grey
mink
ivory
dark brown

Molteni & C

2—
16

DATASHEET

REGISTERED
DESIGN

IX.2023

moltenigroup.com

Dimensions in millimeters and inches. The right to discontinue and make changes is reserved. This information is based on the latest product information available at the time of printing.

MODULARITY

Molteni & C

3-4—
16

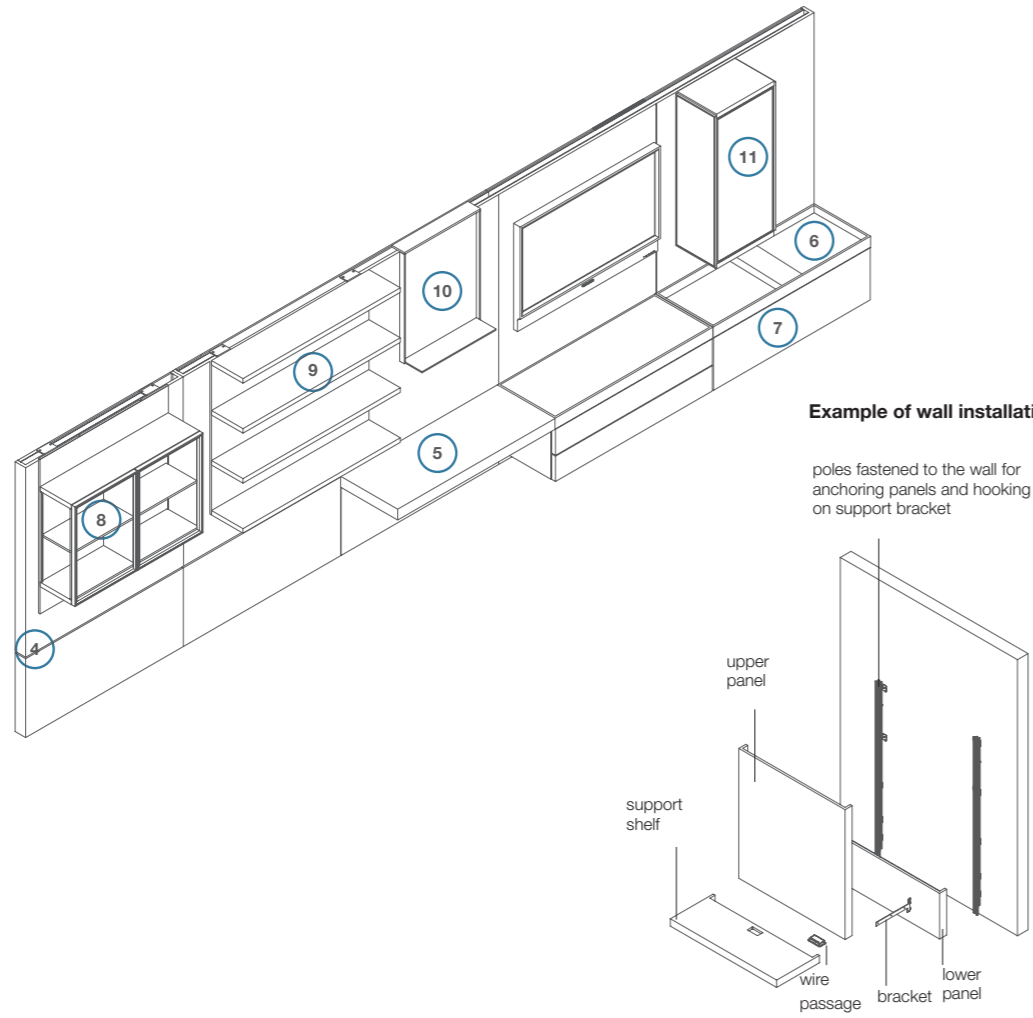
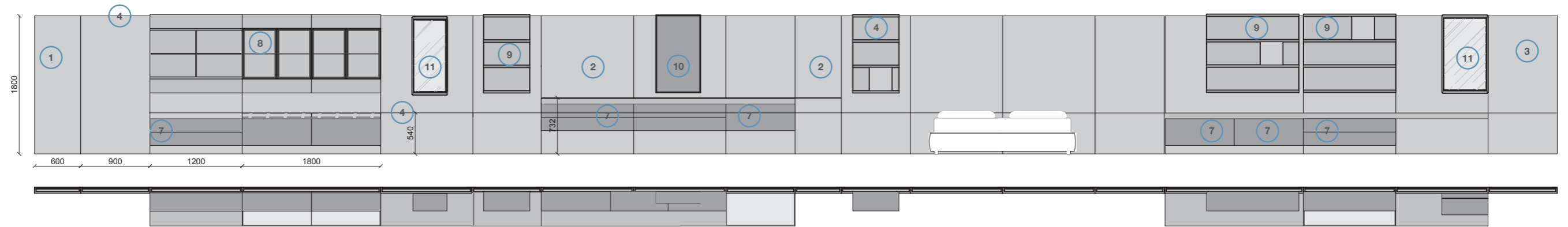

Example of wall installation

- 1 Left lateral panel
- 2 Central panel
- 3 Right lateral panel
- 4 Upper LED lighting and central LED lighting optional + Remote control kit
- 5 Support shelf
- 6 Tray
- 7 Wall-mounted storage unit
- 8 Open wall unit or with doors
- 9 Wall-mounted bookcase
- 10 Display stand
- 11 Display cabinets

Modular panelling
W 600/900/1200/1800 mm
H 540/732 mm - Tot H from floor 1800 mm

MODULARITY

**Modularity
of individual
panelling**

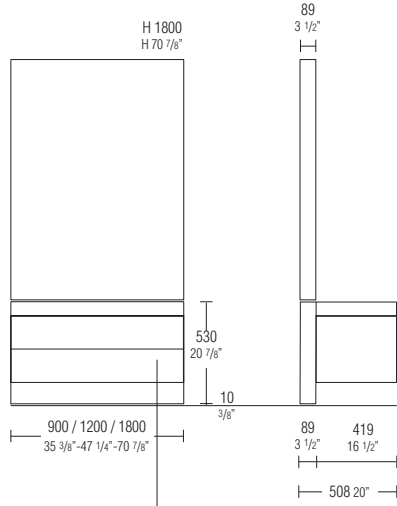

**Modularity
of modular
panelling**

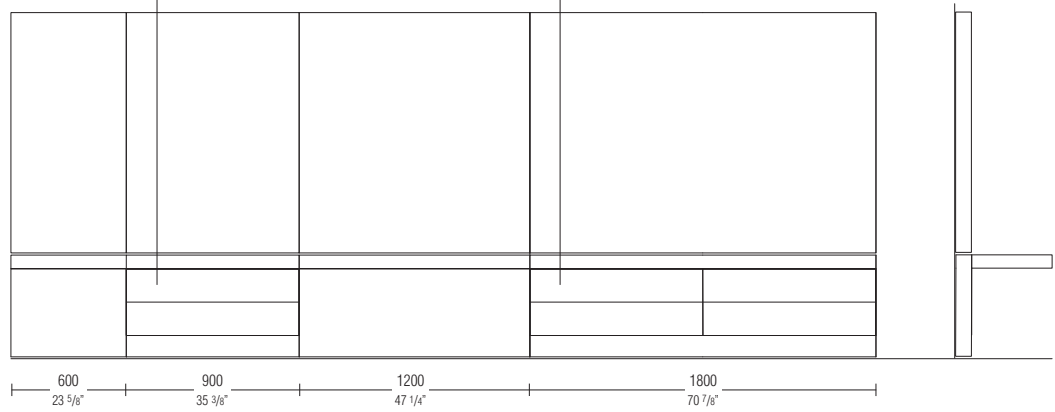

Suspended containers are always of the same width as the panelling since they hook onto the upright sections

Molteni & C

5—
16

DATASHEET

REGISTERED
DESIGN

IX.2023

EXAMPLE OF WIRE PASSAGE

Molteni & C

6—
16

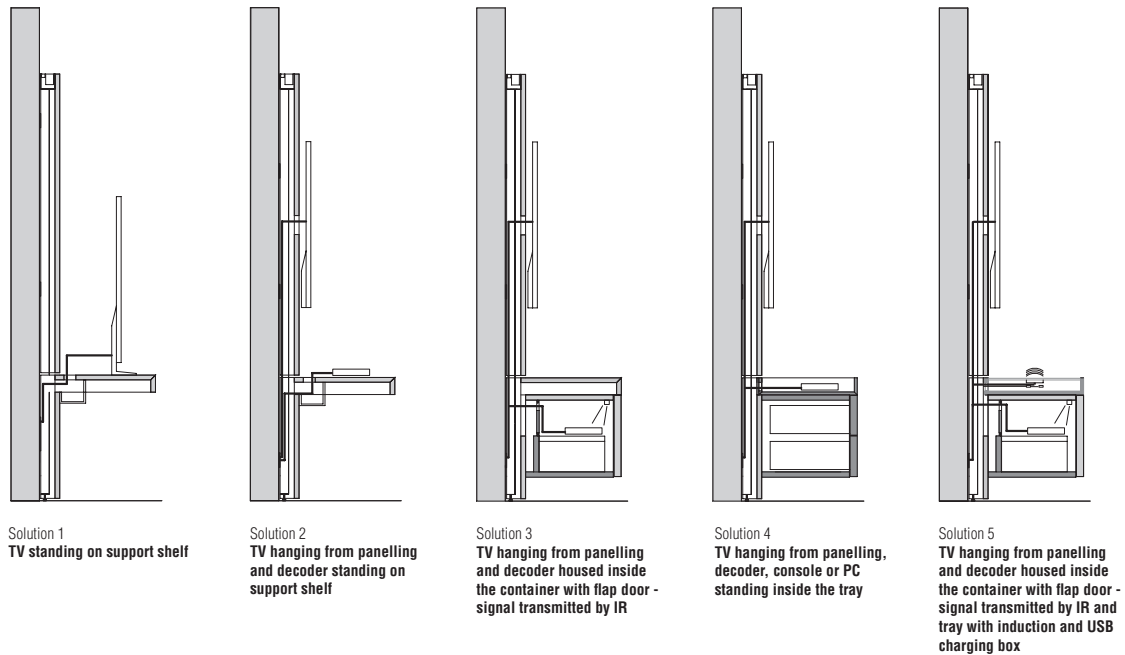
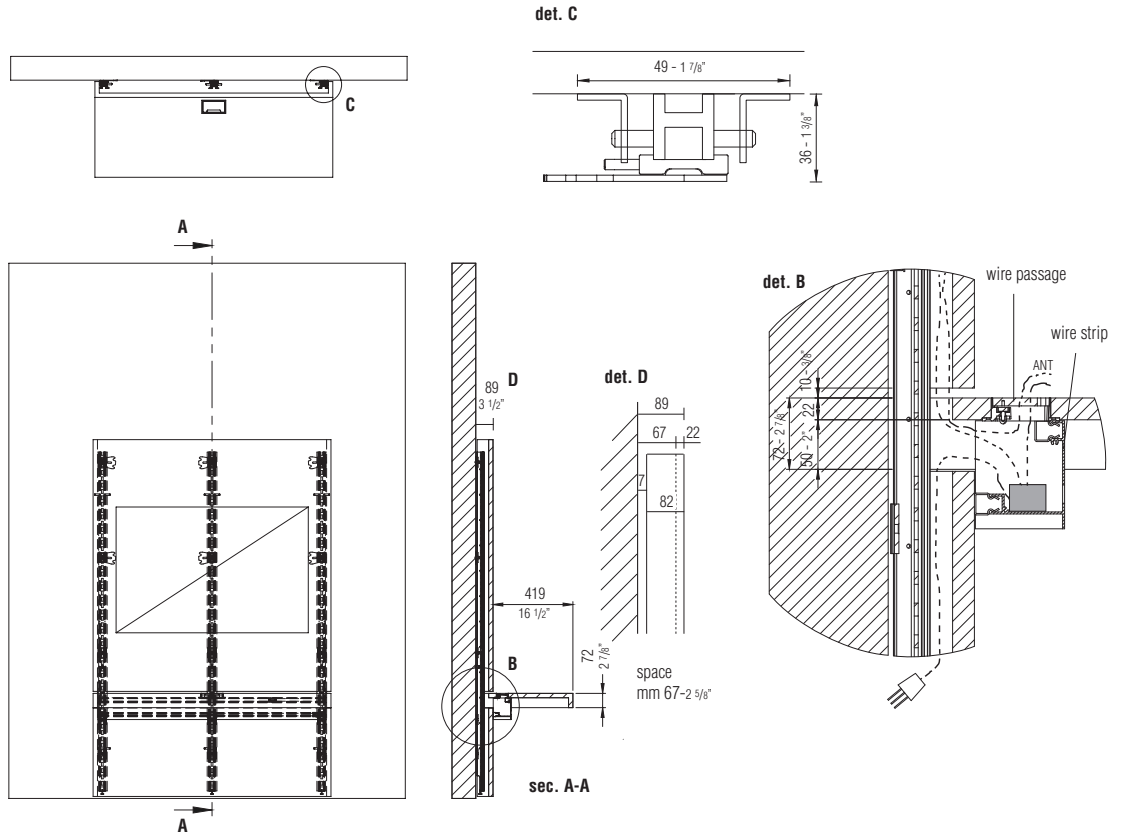

DATASHEET

REGISTERED
DESIGN

IX.2023

DIMENSIONS

Individual panelling D 82 (89 from the wall)
H1 from the ground 540
Total H from the ground 1800

The panels can be reduced in width considering a surcharge (per module).
 Consider a space of 15 mm in width to mount the panels.

Molteni & C

7—
16

All panelling is equipped to receive hanging elements in the upper part

panelling

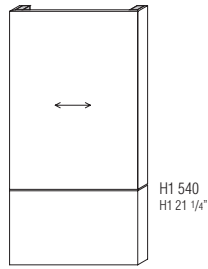

W 900 W 1200 W 1800
PIC09/18A PIC12/18A PIC18/18A

panelling for support shelf

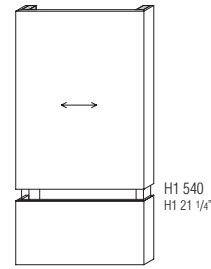

W 900 W 1200 W 1800
PIC09/18B PIC12/18B PIC18/18B

All panelling is equipped to receive hanging elements in the upper part

panelling for hanging container and free-standing container with tray or support shelf

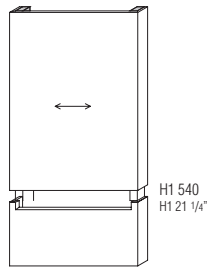

W 900 W 1200 W 1800
PIC09/18C PIC12/18C PIC18/18C

Cannot be made on mirror-finished panelling

work for TV cable passage (to be requested on the order form)

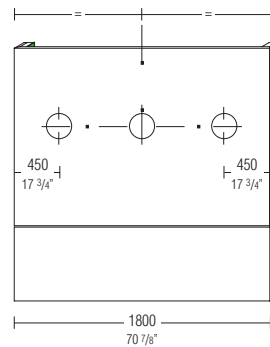
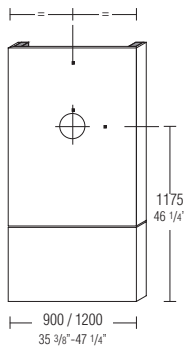

DATASHEET

REGISTERED
DESIGN

IX.2023

DIMENSIONS

Modular panelling D 82 (89 from the wall)
H1 from the ground 540
Total H from the ground 1800

The panels can be reduced in width considering a surcharge (per module).
 Mirror-finished panels cannot be fitted with wire passages and TV sets cannot be fastened to them.
 Consider a space of 15 mm in width to mount the panels.

Molteni & C

8—
16

All panelling is equipped to receive hanging elements in the upper part

left-sx panelling

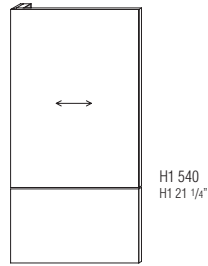

W 600 W 900 W 1200 W 1800
PSC06/18A PSC09/18A PSC12/18A PSC18/18A

left-sx panelling for support shelf

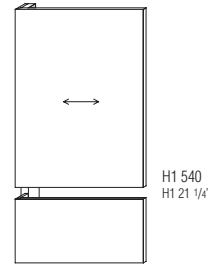

W 600 W 900 W 1200 W 1800
PSC06/18B PSC09/18B PSC12/18B PSC18/18B

left-sx panelling for hanging container and free-standing container with tray or support shelf

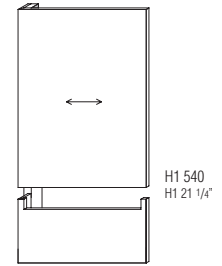

W 600 W 900 W 1200 W 1800
PSC06/18C PSC09/18C PSC12/18C PSC18/18C

All panelling is equipped to receive hanging elements in the upper part

central panelling

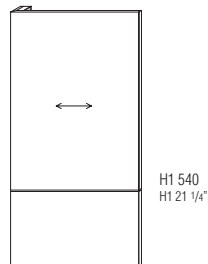

W 600 W 900 W 1200 W 1800
PCC06/18A PCC09/18A PCC12/18A PCC18/18A

central panelling for support shelf

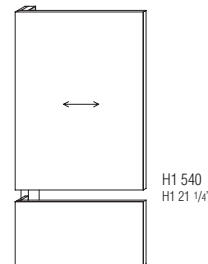

W 600 W 900 W 1200 W 1800
PCC06/18B PCC09/18B PCC12/18B PCC18/18B

central panelling for hanging container and free-standing container with tray or support shelf

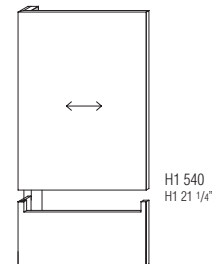

W 600 W 900 W 1200 W 1800
PCC06/18C PCC09/18C PCC12/18C PCC18/18C

All panelling is equipped to receive hanging elements in the upper part

right-dx end panelling

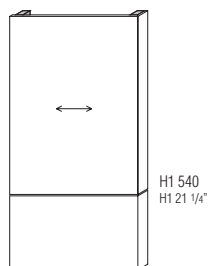

W 600 W 900 W 1200 W 1800
PDC06/18A PDC09/18A PDC12/18A PDC18/18A

right-dx end panelling for support shelf

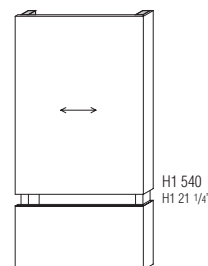

W 600 W 900 W 1200 W 1800
PDC06/18B PDC09/18B PDC12/18B PDC18/18B

right-dx end panelling for hanging container and free-standing container with tray or support shelf

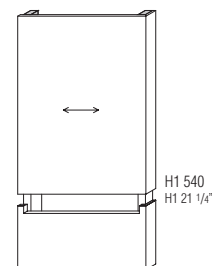

W 600 W 900 W 1200 W 1800
PDC06/18C PDC09/18C PDC12/18C PDC18/18C

DATASHEET

REGISTERED
DESIGN

IX.2023

moltenigroup.com

Dimensions in millimeters and inches. The right to discontinue and make changes is reserved. This information is based on the latest product information available at the time of printing.

DIMENSIONS

Wall panelling lighting

It is possible to light the panelling by inserting LED bars, along the entire length of the composition, in the top part, in the central part, or both.

It is possible to connect the system to a socket with switch, or to use a radio control kit (optional).

Molteni & C

9—
16

**LED bars 6W per metre
max length 3000 mm**
for calculations, consider the sum
of all modules
(3000° K)



per linear meter
EBIML

**power supply
unit 100W**

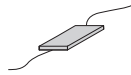

EAL1

**connector
for power supply
units**



EC01

**radio control kit
with brightness
setting
(1 per power supply
unit)
optional**



EKRR1

**DALI kit
(for DOMOTICA)**
n. 1 for each
power supply unit
cannot be used with
radio remote control

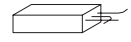

EKDA1

Example of lit wall

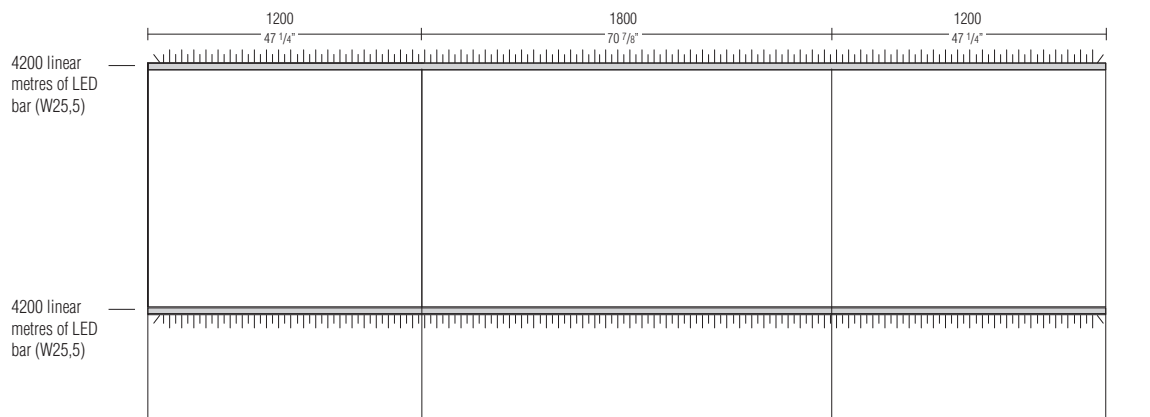

n° 1 power supply unit **EAL1**
n° 1 connector **EC01**
n° 1 radio control kit **EKRR1**

DATASHEET

REGISTERED
DESIGN

IX.2023

DIMENSIONS

Support shelf D 419 H 72

Supporting shelves can be reduced in width considering a surcharge each.

The support shelf is always equipped with the side brackets, while the central brackets must be added according to the modularity of the composition.

Molteni & C

10—
16

support shelf

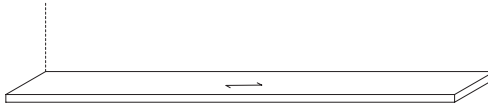

W 600	W 900	W 1200	W 1500	W 1800	W 2100	W 2400	W 2700	W 3000
MAP4/06	MAP4/09	MAP4/12	MAP4/15	MAP4/18	MAP4/21	MAP4/24	MAP4/27	MAP4/30

detachable track underneath the support shelf

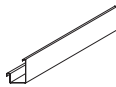

W 900	W 1200	W 1800
MCS09	MCS12	MCS18

central bracket for support shelf



ST4

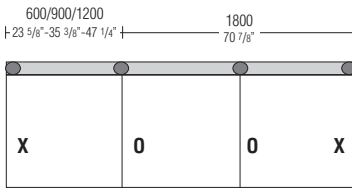

X = included in the price

O = to be added

wire passage for support shelf W 112 D 57



EPA3

Positioning wire passage on the support shelf

The cable gland on the supporting shelf can be positioned in relation to the modules as shown in the specified drawings

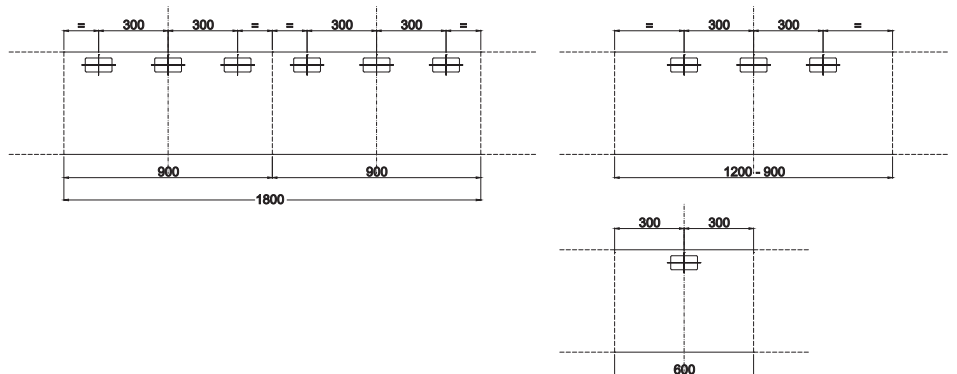

DATASHEET

REGISTERED
DESIGN

IX.2023

moltenigroup.com

Dimensions in millimeters and inches. The right to discontinue and make changes is reserved. This information is based on the latest product information available at the time of printing.

DIMENSIONS

Tray
D 419 H 72

Reductions
No reductions possible

Always to be used resting
on suspended or
free-standing containers

tray
W 600

W 900

W 1200

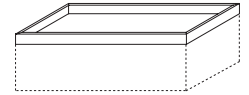
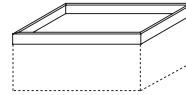
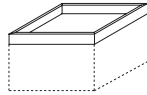

VA4/06

VA4/09

VA4/12

Molteni & C

11—
16

finishes:
ivory
dark brown
grey
mink

bottoms in Eco Skin
for trays W 600

for trays W 900

for trays W 1200



VE4/06

VE4/09

VE4/12

Including the cost
of adding the wire passage
to the tray

charging module
W 150 D 407 H 56
a) Qi inside wireless recharge
b) 2 USB recharge plugs

wire passage
on the tray
W 112 D 57

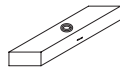

EMR1



EPA5

**tray wire passage position and
charge module position**

W 600

W 900

W 1200

central

central

central

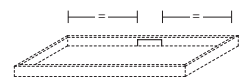
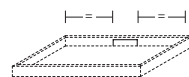
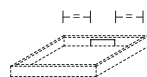

right/left

right/left

right/left



right version

right version

right version

DATASHEET

REGISTERED
DESIGN

IX.2023

DIMENSIONS

Hanging container D 419 H 347

Reductions
No reductions possible

Containers with flap door can be equipped with a wire passage, which must be indicated in the order phase.
The inside is clear of the "T" shelf (optional).

Molteni & C

Always to be used under the support shelf or with top tray

Including fastening brackets

W 600 with pressure-opening flap door

W 900

W 1200

W 1800 (W 900 + W 900)

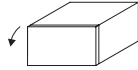

matt lacquer structure wood structure
CQSR06/34



matt lacquer structure wood structure
CQSR09/34



matt lacquer structure wood structure
CQSR12/34

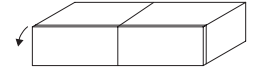

matt lacquer structure wood structure
CQSR18/34

12—
16

Always to be used under the support shelf or with top tray

Including fastening brackets

W 600 with drawers

usable space
W 513 D 326 H 83

W 900

usable space
W 813 D 326 H 83

W 1200

usable space
W 1113 D 326 H 83

W 1800 (W 900 + W 900)

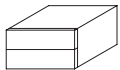

matt lacquer structure wood structure
CQSC06/34



matt lacquer structure wood structure
CQSC09/34



matt lacquer structure wood structure
CQSC12/34

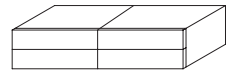

matt lacquer structure wood structure
CQSC18/34

additional "T" shelf H 151 for flap door containers



W 600 RQT06 W 900 RQT09/15 W 1200 RQT12/15

TV signal transmitting/receiving system with LED light for containers with flap door (transmission frequency from 30 to 38 KHz)

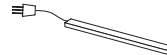

ETV1

DATASHEET

REGISTERED
DESIGN

IX.2023

DIMENSIONS

Wall unit open or with doors

The elements can be hung from the panelling as shown in the composition diagrams, using open wall units with the addition of sides panels and glass doors. To make up wall units with LED spotlights, consider_ kit with 4 spotlights, power supply unit and, if no provision has been made for a controlled socket, the radio control kit. The lighting system for wall units is separate from that for the panelling, but can be included in that for bookcases and glass cabinets, if these do not exceed 100W.

LED light 3000°K.

No reductions or changes of any kind are available. The glass sides must only be used when a door is included.

Composition diagrams

Open

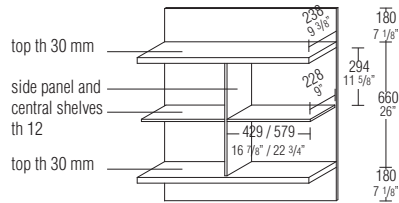

With 1 door

(right-dx or left-sx)

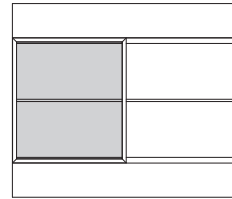

With 2 doors

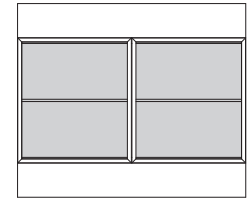

left-sx version

Molteni & C

13—
16

open wall units D 252 H 1020

W 900

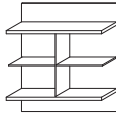

tops, side and central shelves
matt lacquered
GPS09/10

tops, side and central shelves
in wood

W 1200

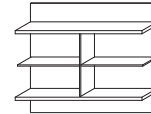

tops, side and central shelves
matt lacquered
GPS12/10

tops, side and central shelves
in wood

glass door W 448 H 658 th 25



GABV04/06

glass door W 598 H 658 th 25



GABV06/06

glass side panel H 600 D 238 th 10



GSV2/06

kit of 4 spotlights W5

EFK4

power supply unit 100W

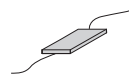

EAL1

radio control kit with brightness setting (1 per power supply unit) optional



EKRR1

connector for power supply units

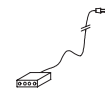

EC01

DATASHEET

REGISTERED
DESIGN

IX.2023

DIMENSIONS

Bookcase D 252

- To create bookcases with LED lighting consider: LED increase, power supply unit and, if there is no pre-fitted element for the switched socket, also the remote control kit.

- The bookcase lighting system is separate from the one for the panelling, but it can be integrated with the one for the glass cabinets if they do not exceed 100W.
- The lighting system includes LEDs on all shelves in the bookcase, excepted the lower shelf.
- 3000° K LED light

Reductions

No reductions possible

Molteni & C

14—
16

H 1020 4 shelves

W 450
12 watt

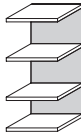

matt lacquer
back
LDS04/10

W 600
15 watt

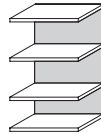

matt lacquer
back
LDS06/10

W 900
22,5 watt

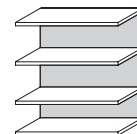

matt lacquer
back
LDS09/10

W 1200
30 watt

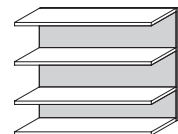

matt lacquer
back
LDS12/10

finishes:
ivory
dark brown
dove grey
black
natural
mud green

Bookcase accessories

partition
W 300 H 298 D 238



DVL03

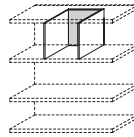

power supply
unit 100W

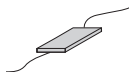

EAL1

radio control kit
with brightness setting
(1 per power supply unit)
optional



EKRR1

connector
for power supply
units



EC01

DATASHEET

REGISTERED
DESIGN

IX.2023

DIMENSIONS

Showcase
D 150

Reductions
No reductions possible

Max capacity of the shelf 5 kg
evenly distributed

H 686
W 580

Molteni & C

15—
16

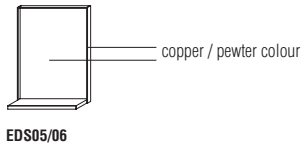

Showcase
with mirror

H 1016
W 580

In the order, specify the finish
of the perimeter profile and
shelf (pewter colour /
copper lacquer)

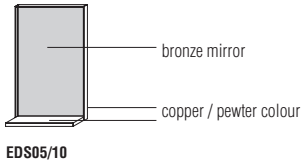

DATASHEET

REGISTERED
DESIGN

IX.2023

DIMENSIONS

Glass cabinet D 300 Glass side

- Pewter colour / copper painted profile.
- Transparent stopsol glass.
- Optional interior lighting.
- To create glass cabinets with LED lighting consider: LED increase, power supply unit and, if there is no pre-fitted element for the switched socket, also the remote control kit.

- The glass cabinet lighting system is separate from the one for the panelling, but it can be integrated with the one for the bookcases if they do not exceed 100W.
- Provision is made to position the LED bar in the lid.
- 3000° K LED light

Reductions

No reductions possible

Molteni & C

16—
16

H 1020
W 600
5 watt
opening only right

inside layout

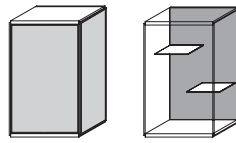

pewter colour/copper
lacquered back
VTSV06/10

**power supply
unit 100W**

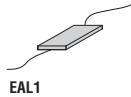

EAL1

**radio control kit
with brightness setting
(1 per power supply unit)
optional**



EKRR1

**connector
for power supply
units**

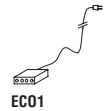

EC01

DATASHEET

REGISTERED
DESIGN

IX.2023