

Molteni & C

45°/TAVOLINO — RON GILAD 2012

1—
3



45°/Tavolino by Ron Gilad, underlines the designer's interest in basic geometric shapes. Complex but essential shapes, "open box" table, of which we can only see the contours, able to integrate into all furnishing solutions with character.

DATASHEET

REGISTERED
DESIGN

2026

WOOD STRUCTURE FINISHES

American walnut - black oak - coffee oak - sunrise oak

METALLIC STRUCTURE FINISHES

black nickel - pewter colour (satin finish)

LOWER SHELVES FINISHES

transparent extraclear glass - smoked glass

marble (black marquina/emperador dark/white Carrara/orient grey/silver wave/green alpine)

Sahara noir marble - calacatta marble - red lapanto marble - avocadus green marble

UPPER SHELVES FINISHES

transparent extraclear glass

smoked glass

TECHNICAL INFORMATION

STRUCTURE

Extruded aluminium covered with wood veneer in Oak (*Quercus*) or American walnut (*Juglans nigra*) or anodised.

GLASS TOP

Tempered glass (5 mm thick).

FEET

Chromed plastic element with non-slip rubber insert for floor placement.

MARBLE TOP

Marble in Range finishes with anti-stain, water-repellent treatments.

WOODEN TOP

Composite panel of MDF and sheet aluminium (1 mm thick), covered with wood veneer.

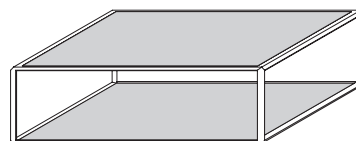
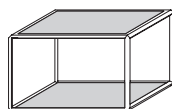
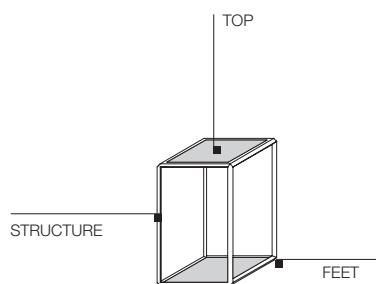

DATASHEET

REGISTERED
DESIGN

2026

DIMENSIONS

Notes

- ▶ The upper shelf can only be in glass.
- ▶ Tables cannot be stacked and fastened together.

floor standing small tables structure

GXT1

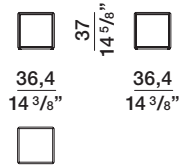

GXT2

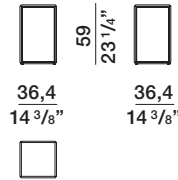

GXT3

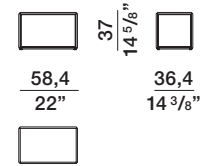

GXT4

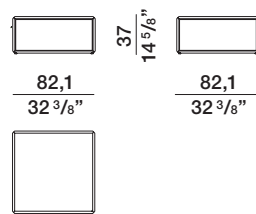

GXT6

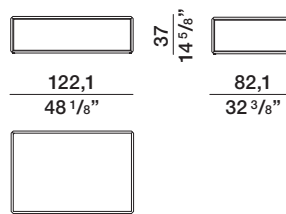

GXT5

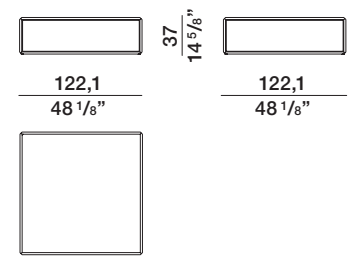

shelves

marble shelves th 1,5-5/8" can only be used for the lower part

for structure

GXRI1

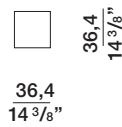

GXRI3

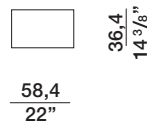

GXRI4

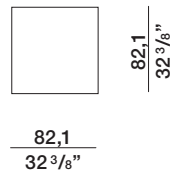

GXRI6

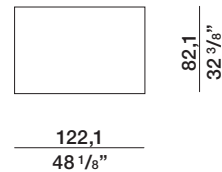

GXRI5

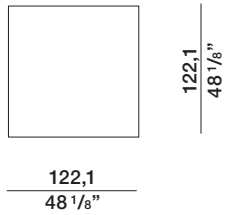

Composite small tables

floor standing small tables with shelves

WGXT1

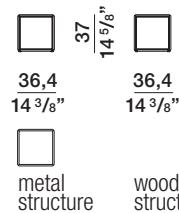

WGXT2

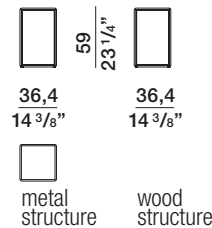

WGXT3

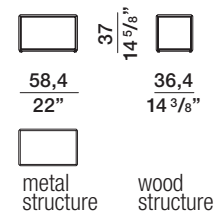

WGXT4

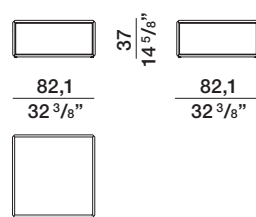

WGXT6

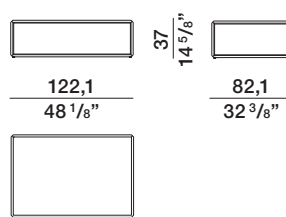

WGXT5

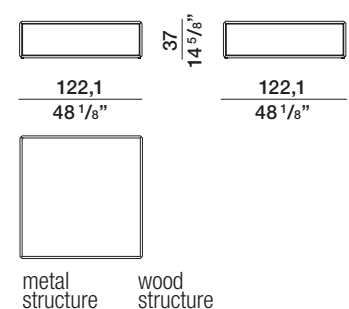

DATASHEET

REGISTERED
DESIGN

2026