

Molteni & C

BLEVIO Table — IGNAZIO GARDELLA 1930 / 2022

1—
3



Designed in 1930, Blevio is a table that Gardella (1905-1999) made as a single model for his own family home, Villa Usuelli in Blevio on Lake Como. It is an extraordinarily harmonious and timeless piece of furniture, which today becomes collective heritage; it combines the purest features and intrinsic simplicity. Gardella was already an established figure on the Italian architecture scene and in those same years he designed Alessandria's Vittorio Emanuele III Sanatorium (1928-1938) with its rationalist chapel, the Hygiene and Prophylaxis Laboratory (1933-1938) and the Antituberculosis Dispensary (1933-1938).

DATASHEET

REGISTERED
DESIGN

IX.2022

BLEVIO
TABLE—
IGNAZIO
GARDELLA
1930 / 2022

FINISHES

LEG/STRUCTURE
FINISHES
eclipse

TOP FINISHES
eclipse
breccia capraia

NOTES

No reductions of any kind are possible.

Molteni & C

TECHNICAL INFORMATION

LEGS

Medium density fibreboard panel, curved in a mould and painted.

ECLIPSE TOP

Painted medium density fibreboard panel and with a metal support structure.

MARBLE TOP

Painted medium density fibreboard panel with a perimeter profile in curved extruded aluminium and a marble top.
Metal support structure.

2—
3

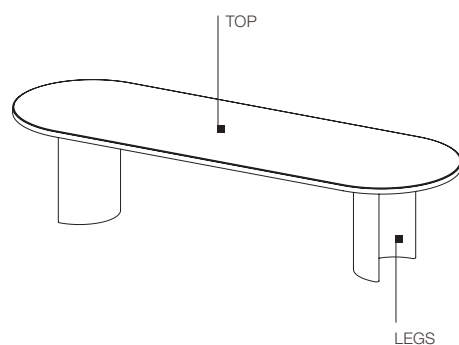

DATASHEET

REGISTERED
DESIGN

IX.2022

moltenigroup.com

Dimensions in centimeters and inches. The right to discontinue and make changes is reserved. This information is based on the latest product information available at the time of printing.

DIMENSIONS

Eclipse single-material table
BT24/10

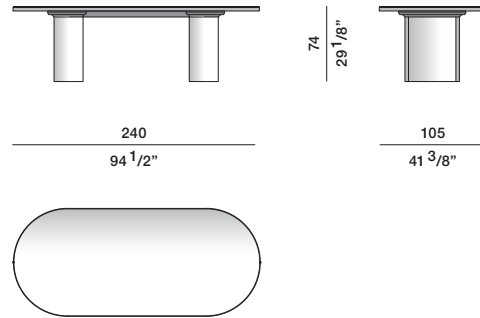
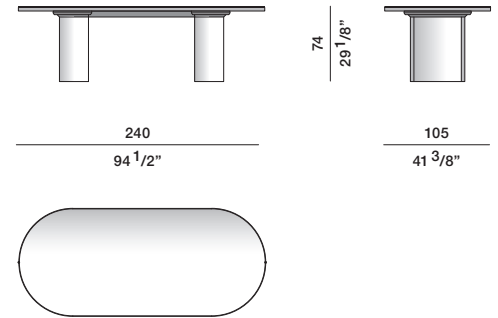

table with Breccia Capraia top
Eclipse structure
BT24/10



Eclipse single-material table
BT28/10

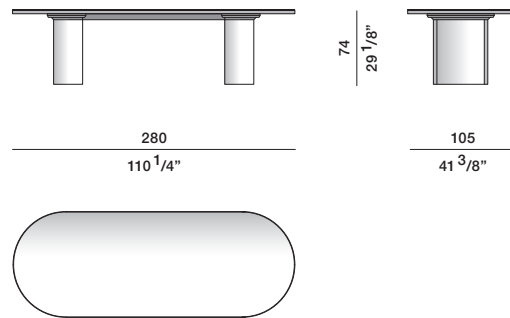
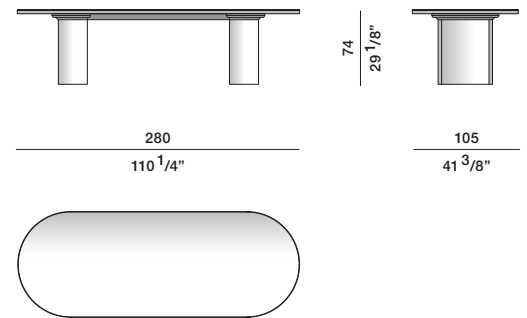
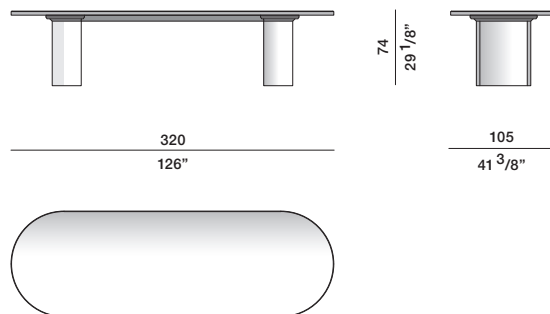

table with Breccia Capraia top
Eclipse structure
BT28/10



Eclipse single-material table
BT32/10



DATASHEET

REGISTERED
 DESIGN

IX.2022