

Molteni & C

PAUL — VINCENT VAN DUYSSEN 2016

1—
11



Paul is a set of elegantly proportioned sofas with reassuring lines, elements that emphasize Vincent Van Duysen's expressive rationality. The project includes linear sofas, angular compositions, chaises longues and islands, all with a single seat cushion. Paul features generous dimensions, distinctive double seams and great comfort, elements that look good, even in the center of the room. The impression is lightweight, accentuated by the neat design of the pressure die-cast aluminum feet. Items featuring considerable depth complete the project, for a comfortable, luxurious and cosy way of sitting.



This symbol shows that the product has removable upholstery. Only qualified personnel can remove the upholstery of some of our products. If this information is pertinent, it will be included in the warnings section.



This symbol shows that the product is available on request in a fire resistant version that complies with the standards BS 5852 and TB 117-2013. The buyer is responsible for checking to make sure that the product is suitable and compliant with the requirements for the designated use and the current applicable laws and standards for the destination and use of the product.

DATASHEET

REGISTERED
DESIGN

I.2024

moltenigroup.com

Dimensions in centimeters and inches. The right to discontinue and make changes is reserved. This information is based on the latest product information available at the time of printing.

FINISHES

BASE FINISH

pewter colour
shiny aluminium

TECHNICAL INFORMATION

STRUCTURE INTERIOR

Frame made of solid Fir (Picea abies) and chipboard, with elastic straps.

STRUCTURE PADDING

High capacity variable density foam polyurethane. Light velvet cover.

DEPTH 100 / DEPTH 120:

SEAT CUSHION

Shaped polyurethane and recycled, biodegradable polyester fibre insert. 100% cotton cover.

BACK CUSHIONS

Recycled, biodegradable polyester fibre. 100% cotton cover.

DEPTH 64:

SEAT CUSHION

Insert in shaped polyurethane and sterilised feathers. 100% cotton cover.

BACK CUSHIONS

Recycled polyester fibre. 100% cotton cover.

FEET

In die cast metal with non-slip plastic tips.

REMOVABLE OUTER COVER

(See attached card, specifically for the cover).



AVAILABLE IN FIRE-RESISTANT
VERSION TB117 AND BS5852

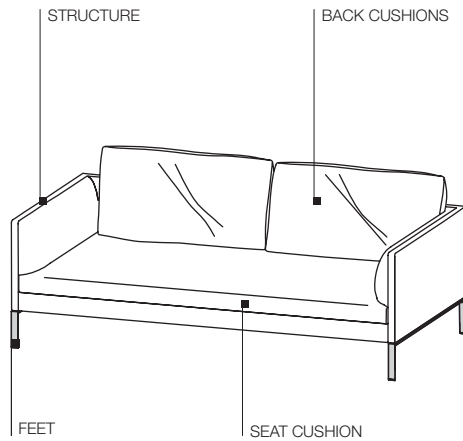

BACKREST CUSHION
WITH ROLL

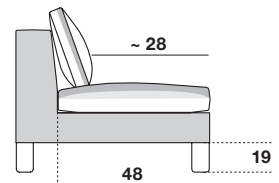
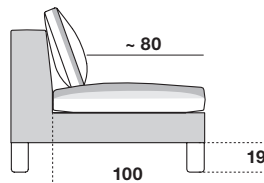
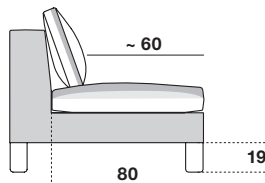
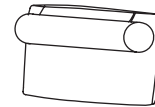

DATASHEET

REGISTERED
DESIGN

I.2024

DEPTH 100 cm

Seat depth for structure only, 80 cm
Seat depth with backrest cushion, ~ 60 cm
Feet height 19 cm (from ground to under seat)

DEPTH 120 cm

Seat depth for structure only, 100 cm
Seat depth with backrest cushion, ~ 80 cm
Feet height 19 cm (from ground to under seat)

DEPTH 64 cm

Seat depth for structure only, 48 cm
Seat depth with backrest cushion, ~ 28 cm
Feet height 19 cm (from ground to under seat)

Notes

- ▶ It is possible to match sofas with different depths, excluding D 64.
- ▶ At the time of ordering, specify the typology of the backrests (with or without the roller).
If backrests with rollers are selected, specify the quantity.

EXAMPLE OF COMPOSITIONS

Molteni & C

3—
11

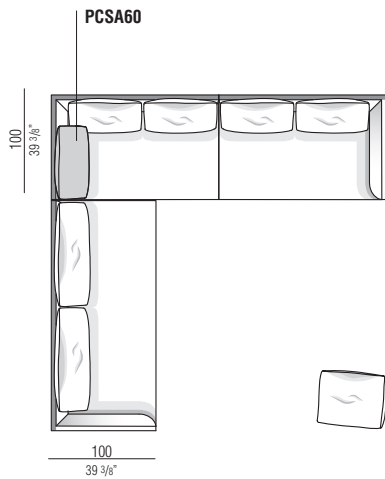

Attention:
in compositions with corner
please add a corner cushion:
for elements with D 100 **cod. PCSA60**
for elements with D 120 **cod. PCSA80**
for elements with D 64 **code CU50**

Corner cushions can also be fitted with headrest
rollers at the specific surcharge, excluding **CU50**

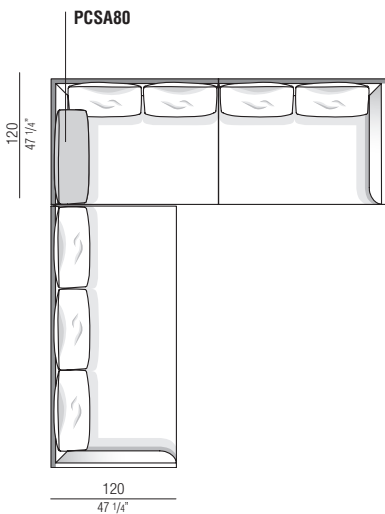

Depth 64

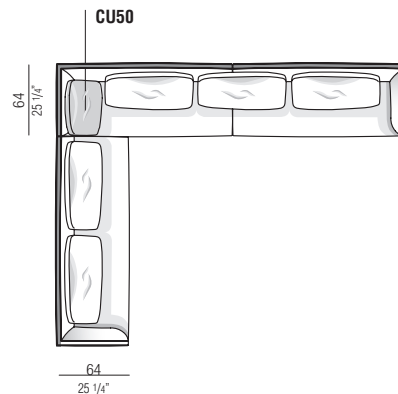
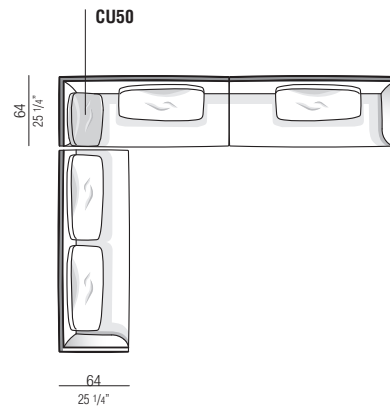

DATASHEET

REGISTERED
DESIGN

I.2024

DIMENSIONS

Paul depth 100

sofas
backrest cushions W 65

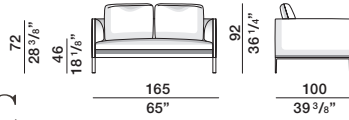

DI1610

backrest cushion W 100

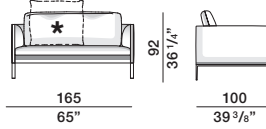

DI1610/B

*** ornamental cushion**

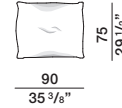

PCU90/75

surcharge for the headrest roller

optional element to match to the single cushion



sofas
backrest cushions W 80

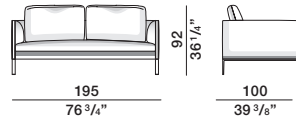

DI1910

backrest cushions W 65

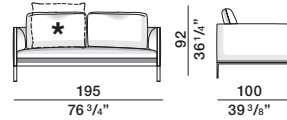

DI1910/B

*** ornamental cushion**

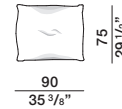

PCU90/75

surcharge for the headrest roller

optional element to match to the single cushion



sofas
backrest cushions W 95

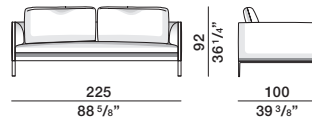

DI2210

backrest cushions W 80

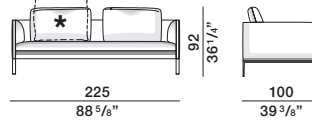

DI2210/B

*** ornamental cushion**

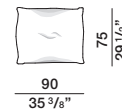

PCU90/75

surcharge for the headrest roller

optional element to match to the single cushion



sofas
backrest cushions W 75

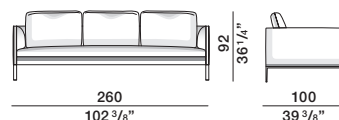

DI2610

backrest cushions W 95

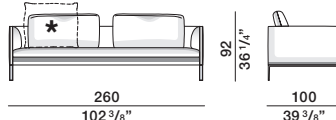

DI2610/B

*** ornamental cushion**

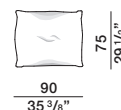

PCU90/75

surcharge for the headrest roller

optional element to match to the single cushion



DATASHEET

REGISTERED
DESIGN

I.2024

DIMENSIONS

Paul depth 100

end elements

backrest cushions W 70

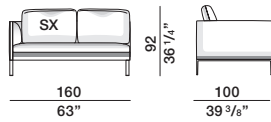

TE1610 dx - sx

backrest cushion W 100

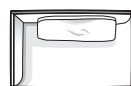
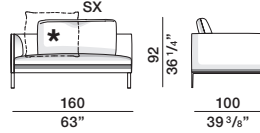

TE1610/B dx - sx

*** ornamental cushion**

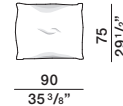

PCU90/75

surcharge for the headrest roller

optional element to match to the single cushion



end elements

backrest cushions W 85

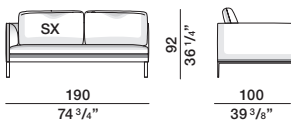

TE1910 dx - sx

backrest cushions W 65

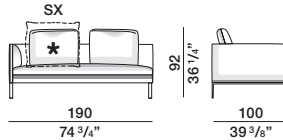

TE1910/B dx - sx

*** ornamental cushion**

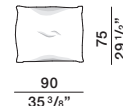

PCU90/75

surcharge for the headrest roller

optional element to match to the single cushion



end elements

backrest cushions W 100

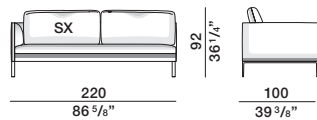

TE2210 dx - sx

backrest cushions W 80

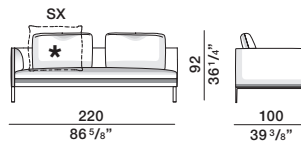

TE2210/B dx - sx

*** ornamental cushion**

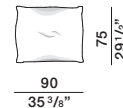

PCU90/75

surcharge for the headrest roller

optional element to match to the single cushion



end elements

backrest cushions W 80

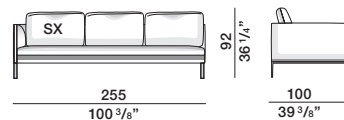

TE2510 dx - sx

backrest cushions W 95

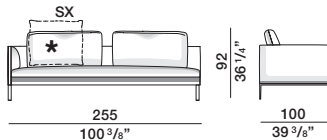

TE2510/B dx - sx

*** ornamental cushion**

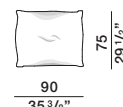

PCU90/75

surcharge for the headrest roller

optional element to match to the single cushion



DATASHEET

REGISTERED
DESIGN

I.2024

DIMENSIONS

Paul depth 100

central
backrest cushions W 70

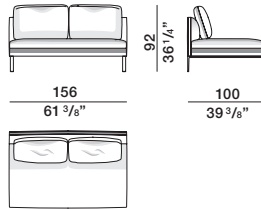

CE1610

backrest cushion W 100

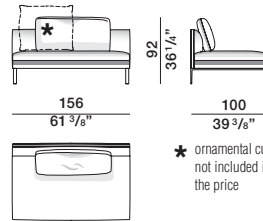

CE1610/B

* ornamental cushion
not included in
the price

*** ornamental
cushion**

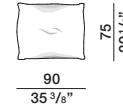

PCU90/75

**surcharge for
the headrest
roller**

optional element
to match
to the single cushion



central
backrest cushions W 85

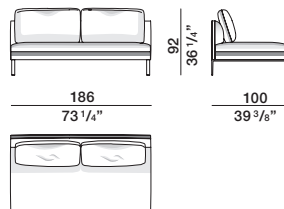

CE1910

backrest cushions W 65

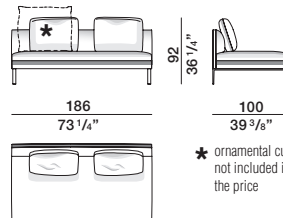

CE1910/B

* ornamental cushion
not included in
the price

*** ornamental
cushion**

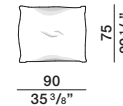

PCU90/75

**surcharge for
the headrest
roller**

optional element
to match
to the single cushion



DATASHEET

REGISTERED
DESIGN

I.2024

DIMENSIONS

Paul common elements

island element
backrest cushions W 80

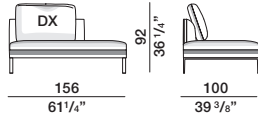

IS1510 dx - sx

surcharge for the headrest roller
optional element to match to the single cushion



chaise longue
backrest cushions W 80

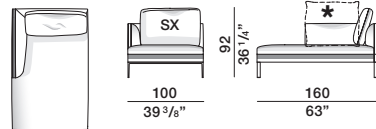

CL1610 dx - sx

*** ornamental cushion**

surcharge for the headrest roller
optional element to match to the single cushion

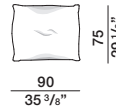

PCU90/75

chaise longue
backrest cushions W 80

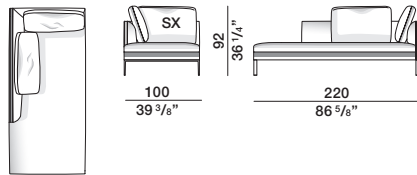

CL2210 dx - sx

backrest cushions W 80

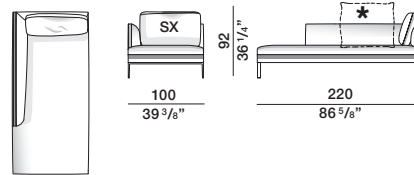

CL2210/B dx - sx

*** ornamental cushion** **surcharge for the headrest roller**
optional element to match to the single cushion

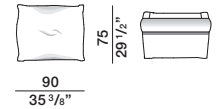

PCU90/75

Paul depth 120

sofas
backrest cushions W 80

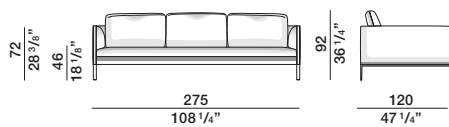

DI2712

backrest cushions W 95

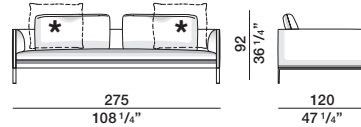

DI2712/B

*** ornamental cushion**

surcharge for the headrest roller
optional element to match to the single cushion



PCU90/75

DIMENSIONS

Paul depth 120

end elements
backrest cushions W 70

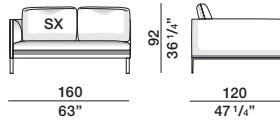

TE1612 dx - sx

backrest cushion W 100

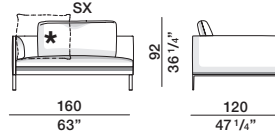

TE1612/B dx - sx

*** ornamental cushion**

surcharge for the headrest roller
optional element to match to the single cushion

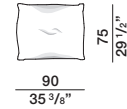

PCU90/75



end elements
backrest cushions W 80



TE2512 dx - sx

backrest cushions W 95

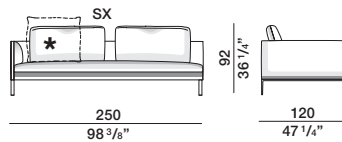

TE2512/B dx - sx

*** ornamental cushion**

surcharge for the headrest roller
optional element to match to the single cushion

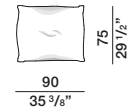

PCU90/75



Paul common elements

pouf

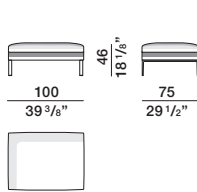

PF1075

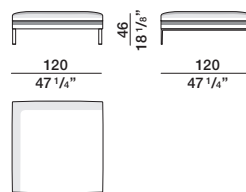

PF1212

surcharge for the headrest roller

optional element to match to the single cushion



corner cushion



PCSA60

corner cushion

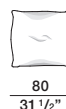

PCSA80

pair of additional cushions

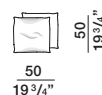

CCQ/50

additional cushion

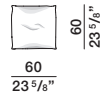

CU/60

additional cushion

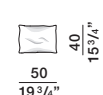

CU/50/40

DATASHEET

REGISTERED
DESIGN

I.2024

DIMENSIONS

Paul depth 64

end

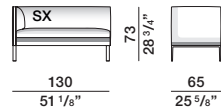

TE1306 dx - sx

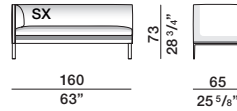

TE1606 dx - sx

end

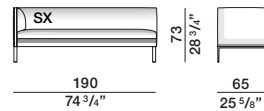

TE1906 dx - sx

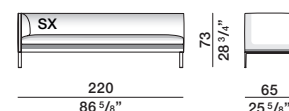

TE2206 dx - sx

**back
and corner
cushions**

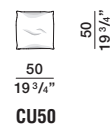

CU50

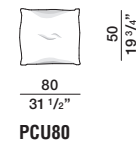

PCU80

DATASHEET

REGISTERED
DESIGN

I.2024

DIMENSIONS

Paul depth 64

central

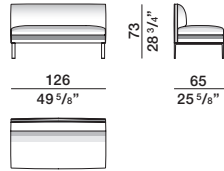

CE1306

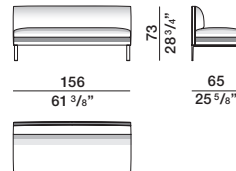

CE1606

central

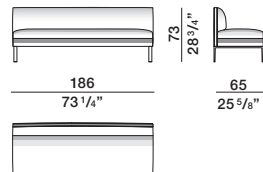

CE1906

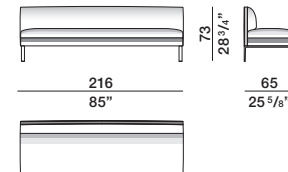

CE2206

**back
cushions**

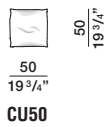

CU50

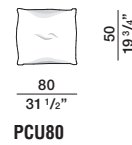

PCU80

DATASHEET

REGISTERED
DESIGN

I.2024

code	gross weight kg.	volume mc.	packages	code	gross weight kg.	volume mc.	packages
CL1610	64	1,527	1	PF1075	22,5	0,505	1
CL2210	89	2,148	1	PF1212	40	0,946	1
CL2210/B	89	2,148	1	TE1610	68	1,626	1
DI1610	73,5	1,619	1	TE1610/B	68	1,626	1
DI1610/B	73,5	1,619	1	TE1612	86	1,868	1
DI1910	90	1,861	1	TE1612/B	86	1,868	1
DI1910/B	90	1,861	1	TE1910	79	1,794	1
DI2210	104	2,139	1	TE1910/B	79	1,794	1
DI2210/B	104	2,139	1	TE2210	92	2,013	1
DI2610	117	2,46	1	TE2210/B	92	2,013	1
DI2610/B	117	2,46	1	TE2510	110	2,424	1
DI2712	130	3,123	1	TE2510/B	110	2,424	1
DI2712/B	130	3,123	1	TE2512	117	2,703	1
IS1510	57	1,474	1	TE2512/B	117	2,703	1