

Molteni & C

HIGH-WAVE — HANNES WETTSTEIN 2007

1—
5



Severe volumes for amazing functionality. Hannes Wettstein designs “architecture for rest” of classic elegance, without giving up ergonomic comfort. An upholstered bed with classic shape and proportions which is embellished by a vertical cord placed on the padded headboard. The inside of the headboard houses a moving mechanism with two positions to ensure adequate support for a comfortable reading position. All versions in the Wave range can be ordered with a structure equipped with a large storage container. The feet have a shiny chrome finish.

In case of customer slatted base and/or mattress, check the correspondence of the measurements with the standard ones in the price list.

For the versions with lifting base, please consider a mattress weight limit of 45 kg.



This symbol shows that the product has removable upholstery. Only qualified personnel can remove the upholstery of some of our products. If this information is pertinent, it will be included in the warnings section.



This symbol shows that the product is available on request in a fire resistant version that complies with the standards BS 5852 and TB 117-2013.

The buyer is responsible for checking to make sure that the product is suitable and compliant with the requirements for the designated use and the current applicable laws and standards for the destination and use of the product.

DATASHEET

REGISTERED
DESIGN

IX.2022

moltenigroup.com

Dimensions in centimeters and inches. The right to discontinue and make changes is reserved. This information is based on the latest product information available at the time of printing.

FINISHES

FEET FINISH
shiny chrome

TECHNICAL INFORMATION

STRUCTURE

Made of solid wood and multi-layered wooden panels upholstered with shaped polyurethane and cover in double-layer velveteen.

HEAD REST

Metallic framework with elastic straps upholstered with polyurethane covered in cold moulded foam. Cover in double-layer velveteen.

BASES (FOR BED-BASE STORAGE CONTAINER)

Melamine finished chipboard panelling with nylon positioning handles.

HIGH FEET

Steel structure covered with polished and varnished plastic material. Supports in antiskid plastic.

LOW FEET

Chrome-plated steel with supports in anti-skid plastic.

INTERNAL CROSSPIECES

Varnished metal.

MATTRESS-BASE SPACER

Plastic.

EXTERNAL REMOVABLE SLIPCOVERS

(See enclosed label, referring to the specific slipcover).



AVAILABLE IN FIRE-RESISTANT
VERSION TB117 AND BS5852

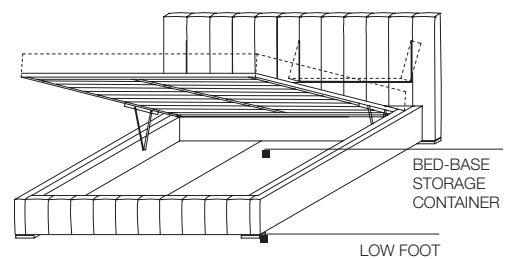
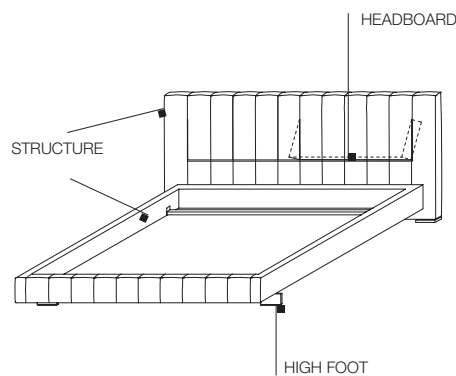

WITHOUT SPACER

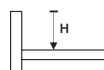

MATTRESS-BASE SPACER

WITH SPACER (1)

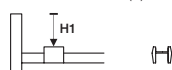

WITH SPACER (2)

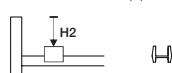

Mattress-base height adjustment

Without spacer	H	11,5
With spacer (1)	H1	9,5
With spacer (2)	H2	7,5

DATASHEET

REGISTERED
DESIGN

IX.2022

DIMENSIONS

Notes

- ▶ Depth of 210 cm (82 3/4") (inner measurement) is also available on HW16 - HW17 - HW18.
- ▶ Depth 210 cm (inner measurement) is not available for beds with container under the slatted base.
- ▶ In the versions with container under the slatted base it is not possible to use slatted bases with electric movement.

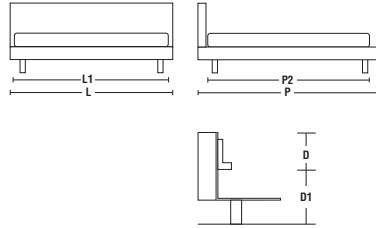

Molteni & C

3—
5

	INNER DIMENSIONS		OUTER DIMENSIONS		D / D1 Space for insertion of the slatted base
	L1 Width	P2 Length	Bed base L Total width	P Length	
HW16-16C/HWF16-16C	160 63"	200 78 3/4" standard model *	180 70 7/8"	220 86 5/8" standard model *	7,5 / 23,5 3" / 9 1/4"
HW17-17C/HWF17-17C	170 66 7/8"	200 78 3/4" standard model *	190 74 3/4"	220 86 5/8" standard model *	9,5 / 21,5 3 3/4" / 8 1/2"
HW18-18C/HWF18-18C	180 70 7/8"	200 78 3/4" standard model *	200 78 3/4"	220 86 5/8" standard model *	11,5 / 19,5 4 1/2" / 7 5/8"
HWKS/HWFKS	195 76 3/4"	205 80 3/4"	215 84 5/8"	225 88 5/8"	
		* 210 on request 82 3/4" beds with container excluded		* 230 on request 90 1/2" beds with container excluded	

Beds with headboard with mechanism

bed taking a single slatted base
or 2 individual slatted bases

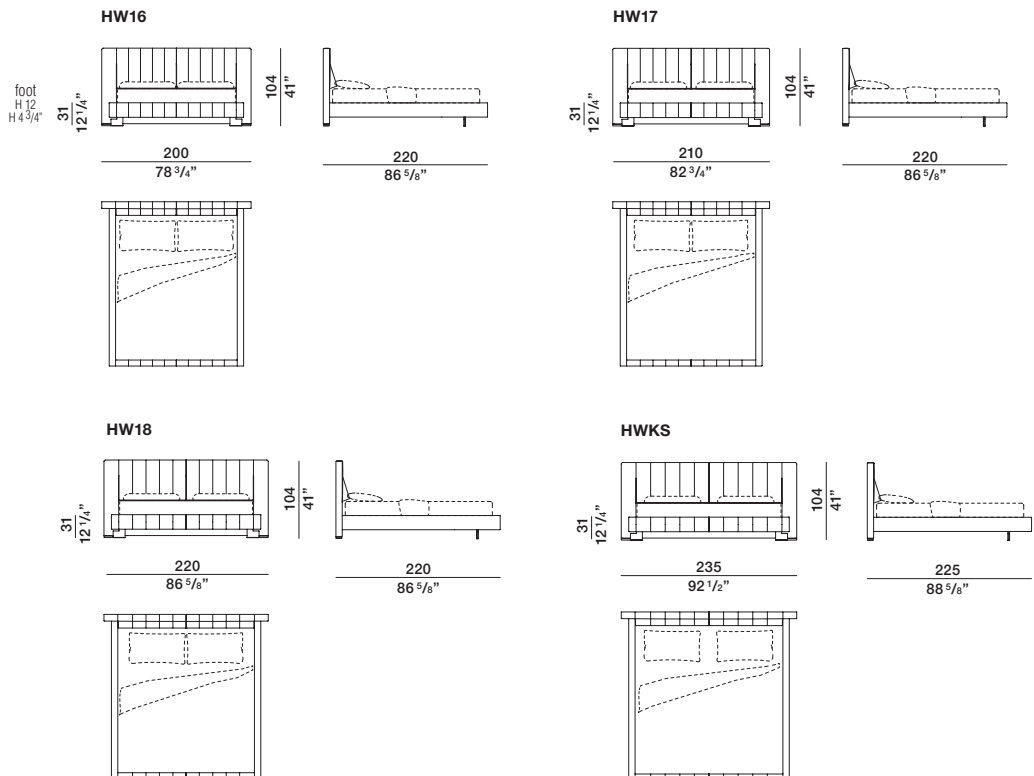

DATASHEET

REGISTERED
DESIGN

IX.2022

DIMENSIONS

Beds with headboard with mechanism

double bed with tilting slatted base and container under the slatted base

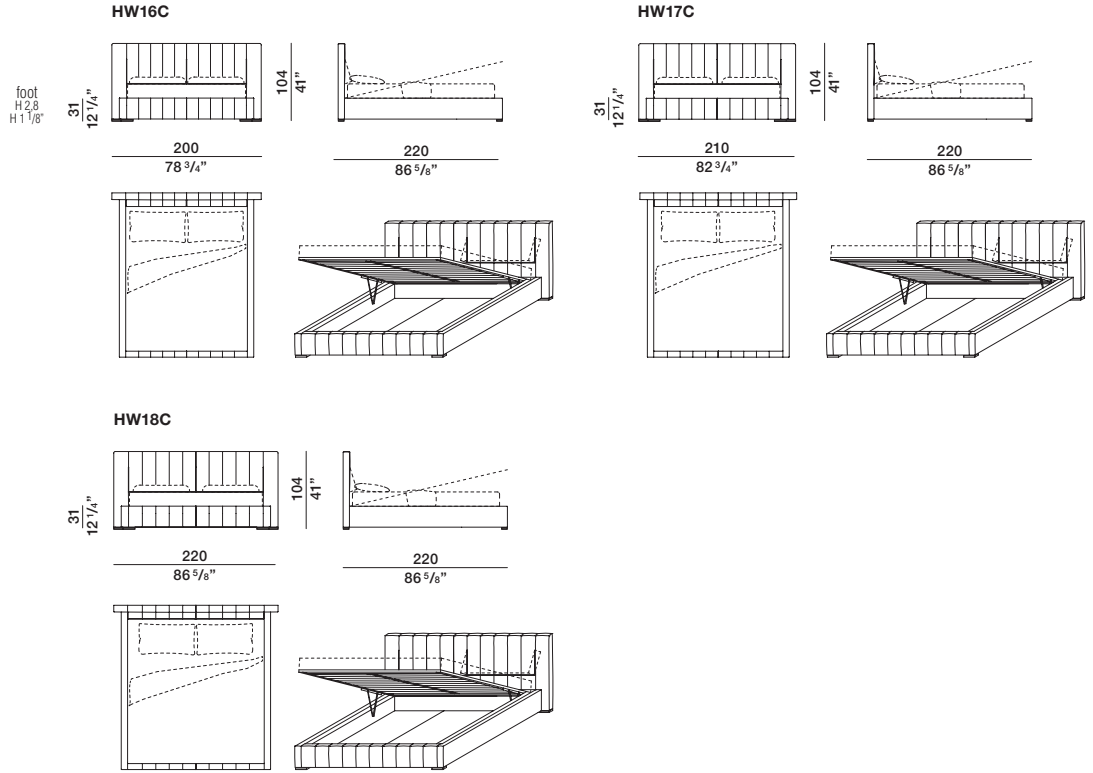

Beds with headboard without mechanism

bed taking a single slatted base or 2 individual slatted bases

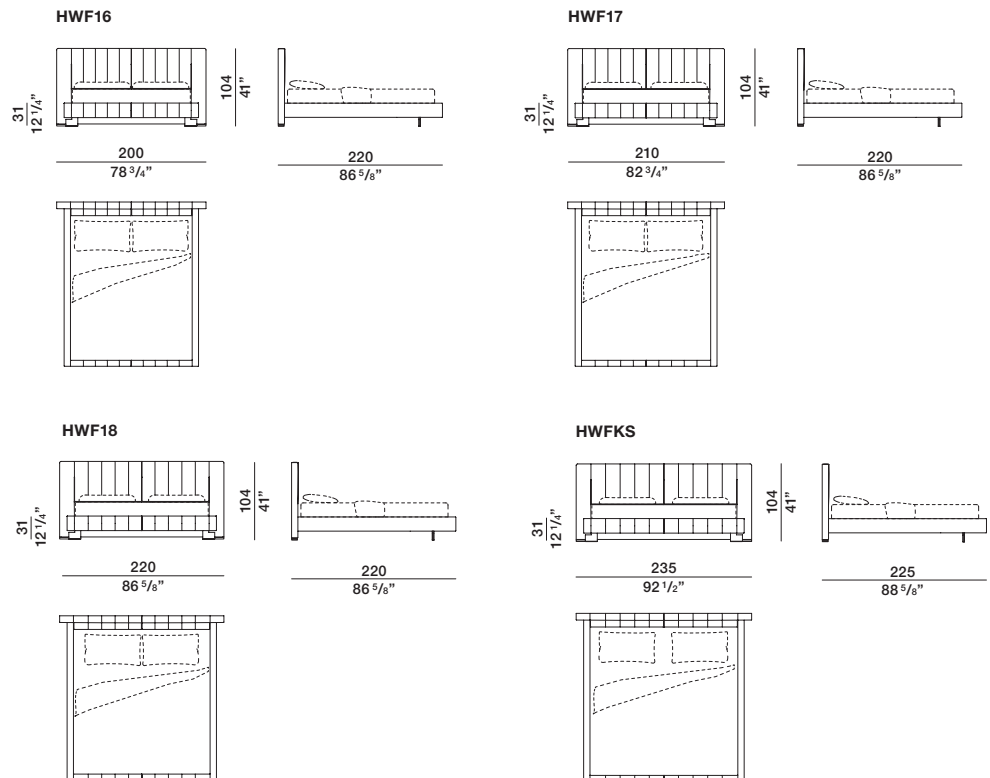

Molteni & C

4—
5

DIMENSIONS

Beds with headboard without mechanism

double bed with tilting slatted base and container under the slatted base

HWF16C

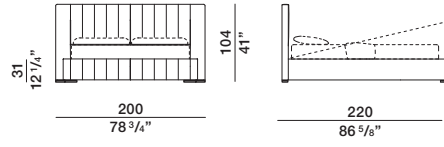

HWF17C

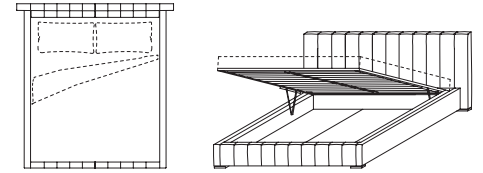
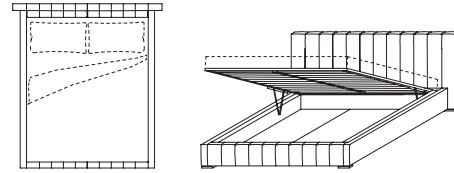
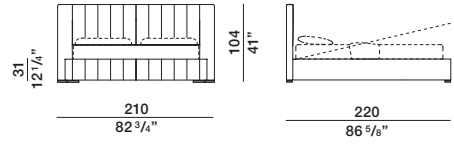

HWF18C

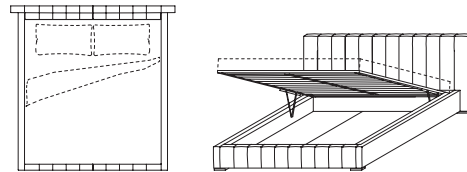
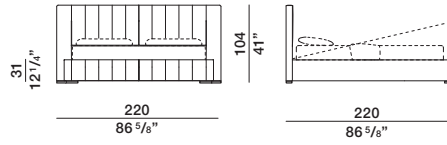

Molteni & C

5—
5

DATASHEET

REGISTERED
DESIGN

IX.2022