

Molteni & C

MARTEEN — VINCENT VAN DUYSSEN 2021

1—
8



The Marteen is a multifunctional seating and storage system introducing harmony with perfectly balanced volumes, in an alternation of solids and voids.



This symbol shows that the product has removable upholstery. Only qualified personnel can remove the upholstery of some of our products. If this information is pertinent, it will be included in the warnings section.



This symbol shows that the product is available on request in a fire resistant version that complies with the standards BS 5852 and TB 117-2013. The buyer is responsible for checking to make sure that the product is suitable and compliant with the requirements for the designated use and the current applicable laws and standards for the destination and use of the product.

DATASHEET

REGISTERED
DESIGN

IX.2023

moltenigroup.com

Dimensions in centimeters and inches. The right to discontinue and make changes is reserved. This information is based on the latest product information available at the time of printing

FINISHES

BASE FINISHES

painted pewter colour

TECHNICAL INFORMATION

INTERNAL STRUCTURE

Frame made of solid Firwood (Picea abies) and wood particle panels with elastic straps.

STRUCTURE PADDING

High performance variable density polyurethane foam. Cover in bonded velveteen.

BACK CUSHIONS

Solotex. 100% cotton cover.

BASE

Feet in painted hot-welded steel with non-slip plastic ferrules.

REMOVABLE OUTER COVER

(See enclosed sheet, specific for the cover in question).

MODULES WITH DRAWER

Top: Honeycombed panel covered with an Oak (Quercus) or Eucalyptus (Eucalyptus globulus) wood veneer;
Drawer: Folded and matt lacquered medium-density fibre panel; structure reinforced with metal plates.

SMALL TABLES WITH DRAWER

Top: Honeycombed panel covered with an Oak (Quercus) or Eucalyptus (Eucalyptus globulus) wood veneer;
Drawer: Folded and matt lacquered medium-density fibre panel; structure reinforced with metal plates.
Base: Wood particle panel, matt lacquered.

SMALL TABLES

Top: Honeycombed panel covered with an Oak (Quercus) or Eucalyptus (Eucalyptus globulus) wood veneer;
Base: Laminate-faced, matt lacquered honeycombed panel.



AVAILABLE IN FIRE-RESISTANT
VERSION TB117 AND BS5852

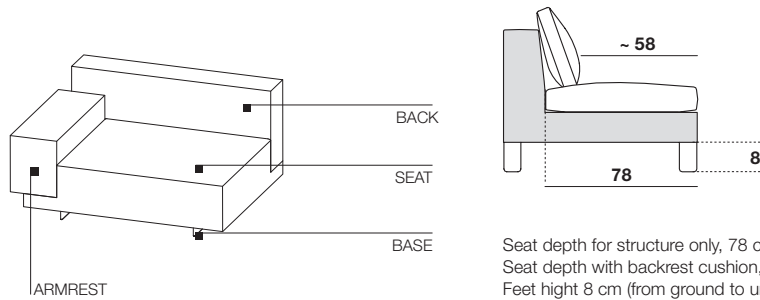

MODULES WITH DRAWER

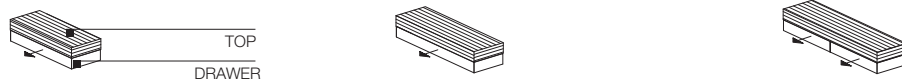

SMALL TABLES WITH DRAWER

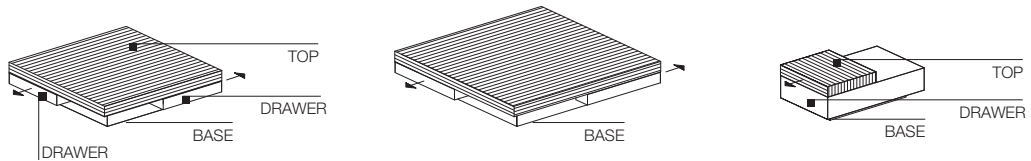

SMALL TABLES

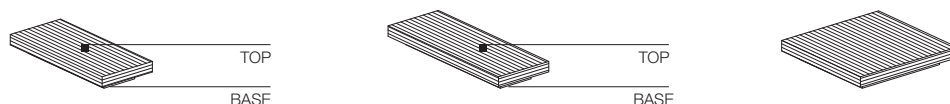

DATASHEET

REGISTERED
DESIGN

IX.2023

NOTES

For correct ergonomics and maximum comfort, it is advisable to design each module using one or more back cushions, according to the sizes proposed in the price list.

In addition to correct ergonomics, the presence of these elements gives the product a complete and elegant appearance.

When ordering

Specify the type and the number of backrests.

Molteni & C

3—
8

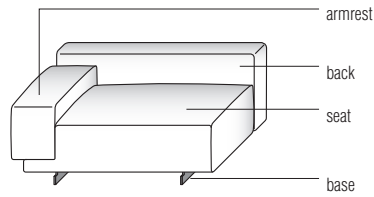

Modules with drawer

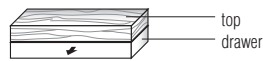

Small tables

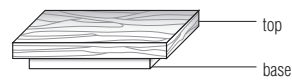

Small tables with drawer

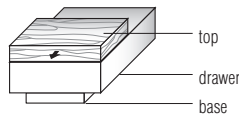
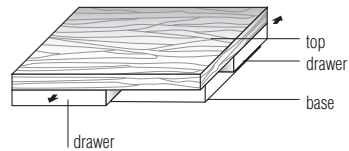

DATASHEET

REGISTERED
DESIGN

IX.2023

DIMENSIONS

Molteni & C

4—
8

end element with low armrest

TEB128 dx - sx

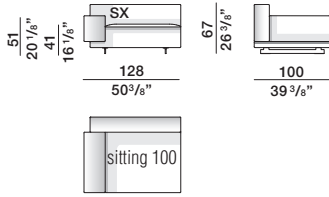

end element with drawer

TEC128 dx - sx

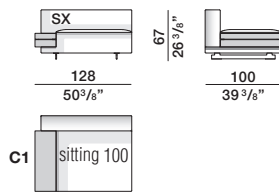

corner end element

TEA120 dx - sx

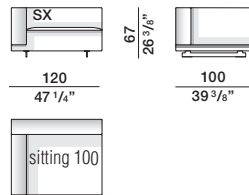

end element with low armrest

TEB108 dx - sx

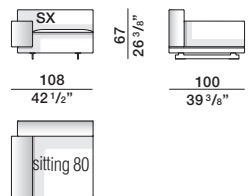

end element with drawer

TEC108 dx - sx

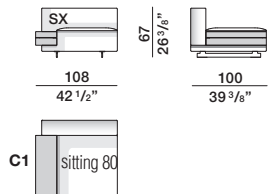

corner end element

TEA100 dx - sx

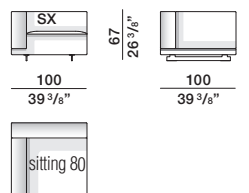

back cushion

CS80/50

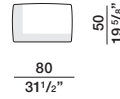

back cushion

CS10/50

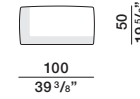

back cushion

CS80/36

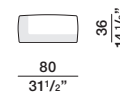

back cushion

CS10/36

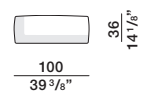

back cushion

CS80/50

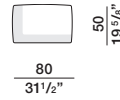

back cushion

CS10/50

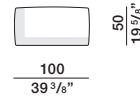

back cushion

CS80/36

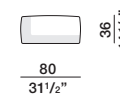

back cushion

CS10/36

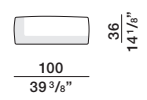

back cushion

CS80/50

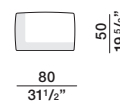

back cushion

CS10/50

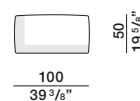

back cushion

CS80/36

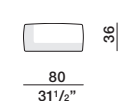

back cushion

CS10/36

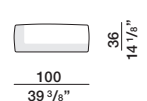

back cushion

CS60/50

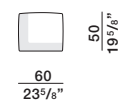

back cushion

CS80/50

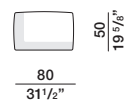

back cushion

CS60/36

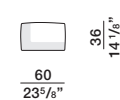

back cushion

CS80/36

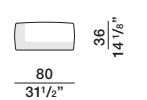

back cushion

CS60/50

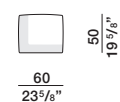

back cushion

CS80/50

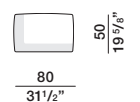

back cushion

CS60/36

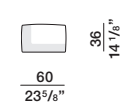

back cushion

CS80/36

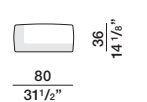

back cushion

CS60/50

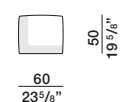

back cushion

CS80/50

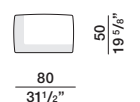

back cushion

CS60/36

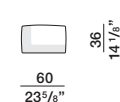

back cushion

CS80/36

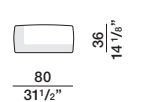

DATASHEET

REGISTERED
DESIGN

IX.2023

DIMENSIONS

central element
CEN120

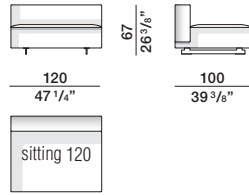

seat with drawer
CEC120

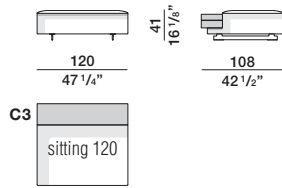

central element
CEN100

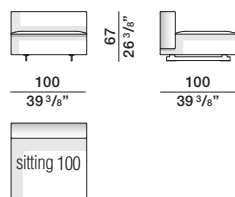

seat with drawer
CEC100

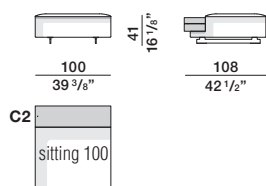

central element
CEN080

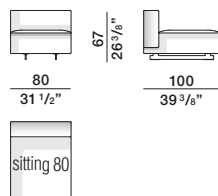

seat with drawer
CEC080

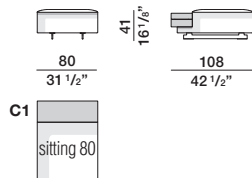

back cushion

CS10/50

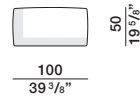

back cushion

CS60/50

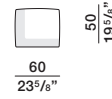

back cushion

CS10/36

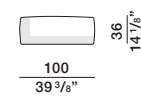

back cushion

CS60/36

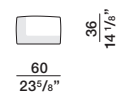

back cushion

CS80/50

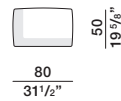

back cushion

CS10/50

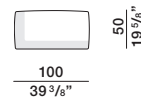

back cushion

CS80/36

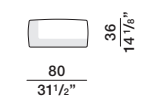

back cushion

CS10/36

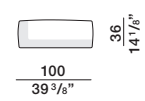

back cushion

CS60/50

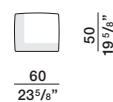

back cushion

CS80/50

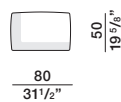

back cushion

CS60/36

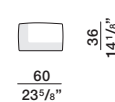

back cushion

CS80/36

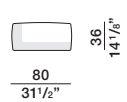

DATASHEET

REGISTERED
DESIGN

IX.2023

DIMENSIONS

low armrest island

ISB128 dx - sx

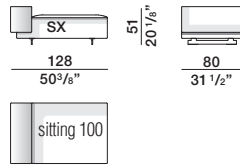

island with drawer

ISC128 dx - sx

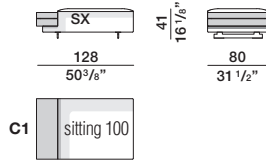

low armrest island

ISB108 dx - sx

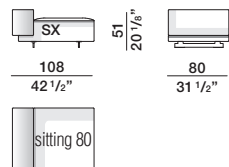

island with drawer

ISC108 dx - sx

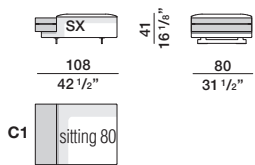

chaise longue with low armrest

CLB128 dx - sx

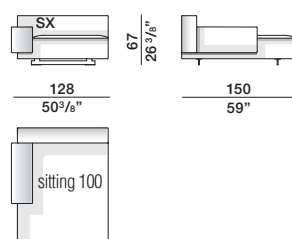

chaise longue with drawer

CLC128 dx - sx

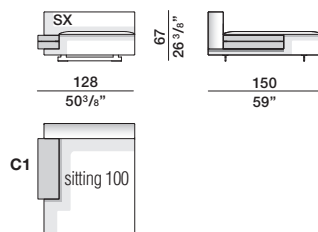

back cushion

CS80/50

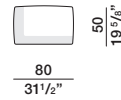

back cushion

CS10/50

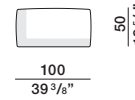

back cushion

CS80/36

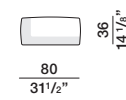

back cushion

CS10/36

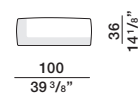

back cushion

CS80/50

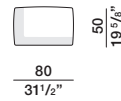

back cushion

CS10/50

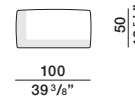

back cushion

CS80/36

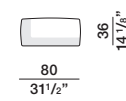

back cushion

CS10/36

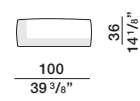

back cushion

CS60/50

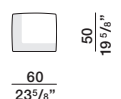

back cushion

CS80/50

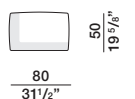

back cushion

CS60/36

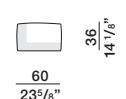

back cushion

CS80/36

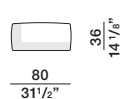

back cushion

CS60/50

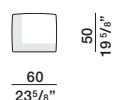

back cushion

CS80/50

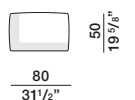

back cushion

CS60/36

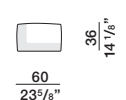

back cushion

CS80/36

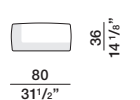

back cushion

CS80/50

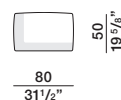

back cushion

CS10/50

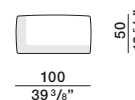

back cushion

CS80/36

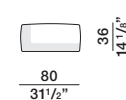

back cushion

CS10/36

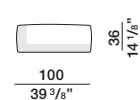

back cushion

CS80/50

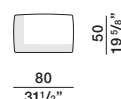

back cushion

CS10/50

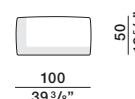

back cushion

CS80/36

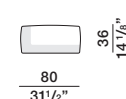

back cushion

CS10/36

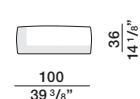

DATASHEET

REGISTERED
DESIGN

IX.2023

DIMENSIONS

daybed
DBE100

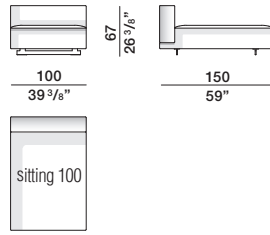

back cushion
CS80/50

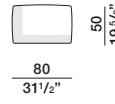

back cushion
CS10/50

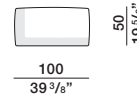

back cushion
CS80/36

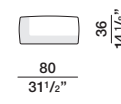

back cushion
CS10/36

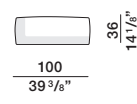

pouf
PF12/10

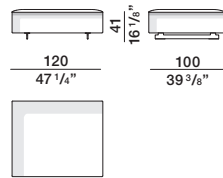

pouf
PF10/10

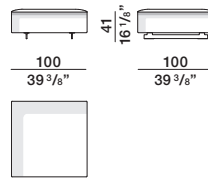

pouf
PF60/10

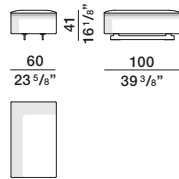

pouf
PF10/80

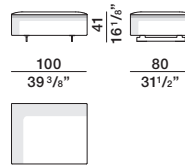

pouf
PF80/80

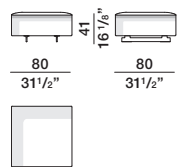

ornamental cushion
PCU90/75

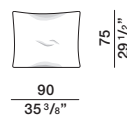

ornamental cushion
CF48

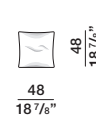

DATASHEET

REGISTERED
DESIGN

IX.2023

FINISHES

DRAWERS
AND BASE FINISH
pewter colour lacquered

TOP FINISHES

eucalyptus
thermo oak

ATTENTION:

► The modules with drawers (C1-C2-C3) can not ordered individually, but only in combination with the modules provided as per the price list

► No reductions of any kind are possible

Molteni & C

8—
8

DIMENSIONS

**C1
module with 1 drawer**

CAS1

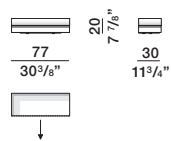

small table

TAV1

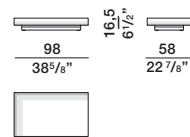

small table with 2 drawers

TAC2

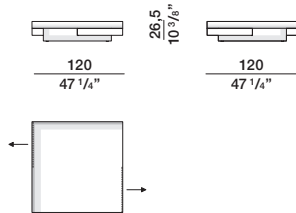

**C2
module with 1 drawer**

CAS2

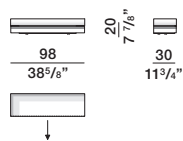

small table

TAV2

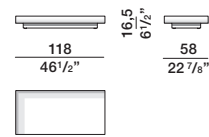

small table with 2 drawers

TAC3

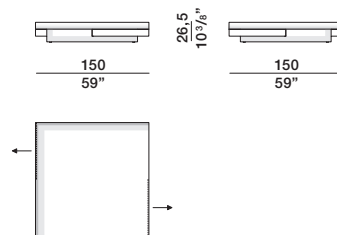

**C3
module with 2 drawers**

CAS3

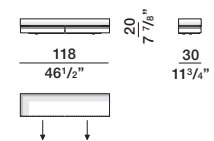

small table

TAV3

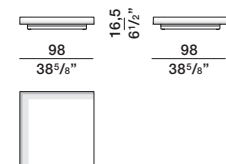

small table with 1 drawer

TAC1

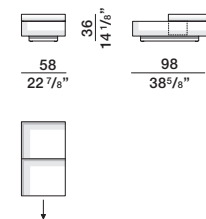

code	gross weight kg.	volume mc.	packages	code	gross weight kg.	volume mc.	packages
TEB128	69	1,1	1	CLC128	72	1,56	1
TEC128	59,5	1,05	1	DBE100	62	1,25	1
TEA120	67	1,025	1	PF12/10	40	0,63	1
TEB108	61,8	0,94	1	PF10/10	36,8	0,53	1
TEC108	53	0,88	1	PF60/10	29	0,34	1
TEA100	61	0,87	1	PF10/80	32	0,46	1
CEN120	62	1,07	1	PF80/80	29	0,37	1
CEC120	42,5	0,8	1	CAS1	21	0,073	1
CEN100	55	0,92	1	CAS2	23	0,16	1
CEC100	38,5	0,6	1	CAS3	37	0,27	1
CEN080	48	0,69	1	TAV1	23	0,16	1
CEC080	34	0,443	1	TAV2	27	0,18	1
ISB128	45	0,69	1	TAV3	37	0,27	1
ISC128	35	0,61	1	TAC1	36	0,3	1
ISB108	42	0,63	1	TAC2	0,72	77	3
ISC108	32	0,475	1	TAC3	0,9	95,5	3
CLB128	81	1,63	1				

DATASHEET

REGISTERED
DESIGN

IX.2023