

Molteni & C

TOUCH DOWN UNIT — STUDIO KLASS 2020 UNIFORM FOR MOLteni&C

1—
4



This small but functional mobile station fits the bill. It can easily follow someone around the home, adapting itself to continuous changes in layout and spatial configuration and to a range of usage modes for working seated on an armchair, office chair or stool, or standing. It acts as a service module, providing a place to store your bag and other personal items, work on a laptop, check your email, answer a message, make a phone call, or charge your devices. The project was in fact created for, and designed around, individual workers who live in different ways each day—and throughout the day—depending on the activity to be carried out.

The mobile unit has a metal structure consisting of a base with a central upright fixed to it. The upright also supports the structure of the worktop, which features vertical and horizontal sliding devices that allow the user to adjust the height and position of the worktop so that it is comfortable and ergonomic for every type of activity. The unit has a compartment where a rechargeable power bank can be inserted. The central structural upright is accessorised also with USB ports where electronic devices can be charged. To facilitate moving the workstation about the office the base is on concealed 360° swivel castors.

DATASHEET

REGISTERED
DESIGN

IX.2023

FINISHES

Finish pairings

shell	American walnut *
central body	painted bronze
worktop	American walnut *

* UniFor American walnut finish
sample available on request

Molteni & C

2—
4

TECHNICAL INFORMATION

CENTRAL BODY

Structure in painted metal with door designed for electrification.

EXTERNAL SHELL IN WOOD

Medium density fibreboard panel with solid wood edges, covered in wood veneer.

WORKTOP

American walnut with solid wood edges.

CASTORS

Base fitted with concealed castors with 360° rotation.

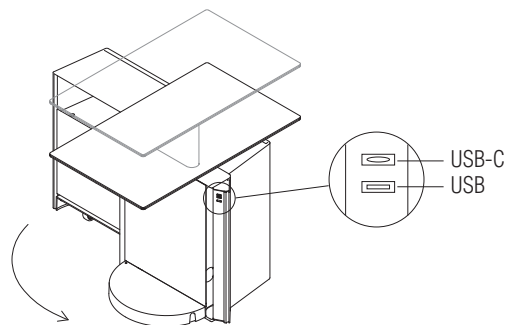

DATASHEET

REGISTERED
DESIGN

IX.2023

DIMENSIONS

Notes

The TDU has a compartment that can contain a power bank.
The power bank is not supplied with the product.
It is advisable to use a power bank with a USB-C power output and laptop charge capacity.
Max. dimensions for purchasing the power bank:
H 23 x W 7 x D 2,5 cm / H 23 x W 7,5 x D 2 cm
H 9" x W 2 3/4" x D 1" / H 9" x W 3" x D 3/4"

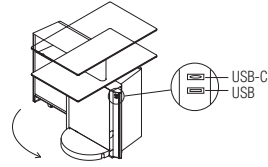

Molteni & C

mobile station

PMO1

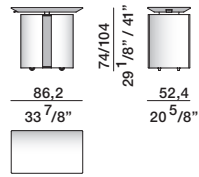

dimensions of internal compartments

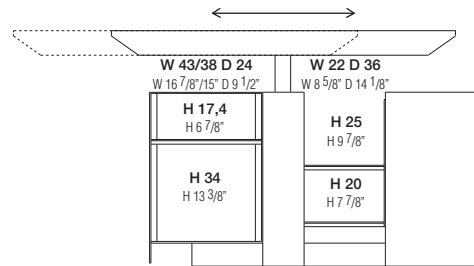

3—
4

internal fittings

W 22/19 D 24,2
W 8 5/8" / 7 1/2" D 9 1/2"

W 22/19 D 24,2
W 8 5/8" / 7 1/2" D 9 1/2"

W 44/38 D 24,2
W 17 3/8" / 15" D 9 1/2"

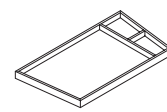
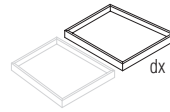
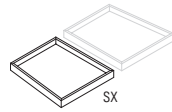

trays

VAS1

VAD1

VA2

dimensions of the different configurations

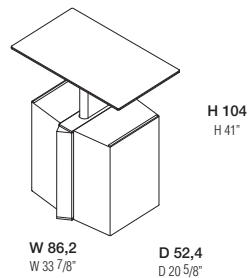
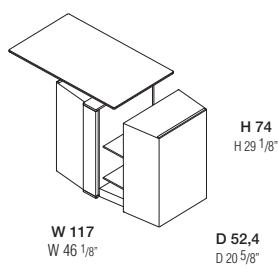
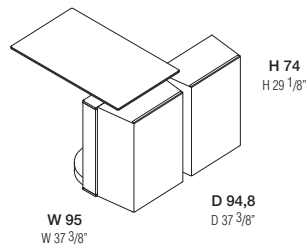
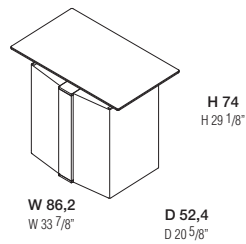

DATASHEET

REGISTERED
DESIGN

IX.2023

TOUCH
DOWN UNIT—
STUDIO KLASS
2020

DESCRIPTION

Molteni & C

4—
4

- 1 Sliding height adjustable worktop
- 2 Container with horizontal glide opening
- 3 Container with rotational opening
- 4 Auxiliary shelves
- 5 Compartment for personal items
- 6 360° swivel castors
- 7 Power bank compartment



painting bronze

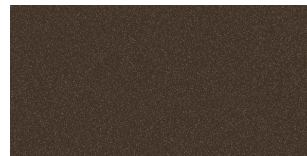

UniFor American walnut finish

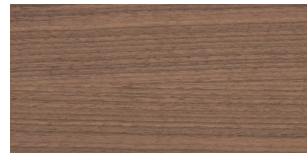

DATASHEET

REGISTERED
DESIGN

IX.2023

moltenigroup.com

Dimensions in centimeters and inches. The right to discontinue and make changes is reserved. This information is based on the latest product information available at the time of printing