

# Molteni & C

## **BELSIZE —** RODOLFO DORDONI 2017

1—  
3



Original series of small, round and trapezoidal tables. Always three-legged, metallic with a pewter finish and of two heights. Table tops with rounded edges made of eucalyptus or graphite oak, glossy anthracite or clay. Some versions can be fitted with orient grey or black marquina marble tops. Designed for various functions; small coffee or occasional tables, they can be included in the components of the Sloane system to create articulated compositions. In the version with tall legs they become desks or small breakfast or cocktail tables.

### DATASHEET

REGISTERED  
DESIGN

IX.2020

## FINISHES

### FINISHES OF TABLES TOPS WITH PEWTER COLOUR LEGS

eucalyptus  
graphite oak  
glossy clay  
glossy anthracite  
(other glossy colours from the  
Molteni range available at extra cost)

### FINISHES OF MARBLE TOPS ON BTV1 - BTV5 - BTV6

orient grey  
black marquina

# Molteni & C

2—  
3

## TECHNICAL INFORMATION

### LEG

Tapered, painted metal tube. Bracket for fastening to the painted die-cast aluminium top.  
Painted metal ferrule with non-slip rubber pad.

### WOOD TOP

Medium density fibre panel covered with Eucalyptus wood veneer (*Eucalyptus globulus*) and Oak (*Quercus*) or  
finished in glossy lacquer in range colours.

### MARBLE TOP

Marble in range finishes.

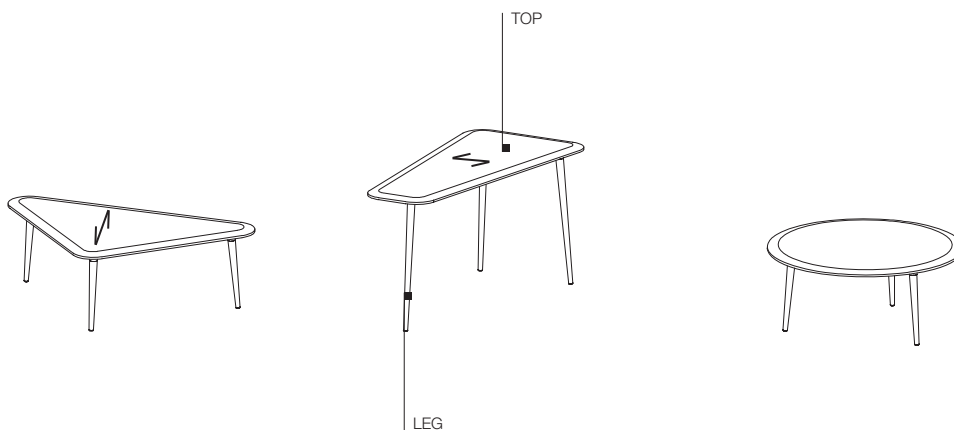

## DATASHEET

REGISTERED  
DESIGN

IX.2020

**DIMENSIONS**

**small tables**

**BTV1**

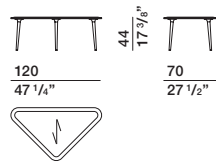

**BTV2**

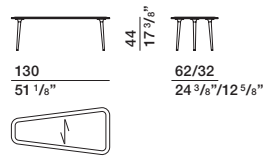

**BTV5**

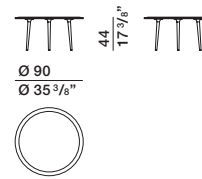

**BTV4**

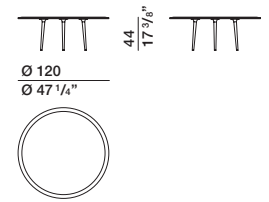

**Molteni & C**

**consoles**

**BTV3**

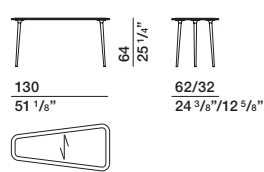

**BTV6**

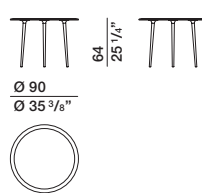

**BTV7**

