

## PRIME

DADA R&D 2018

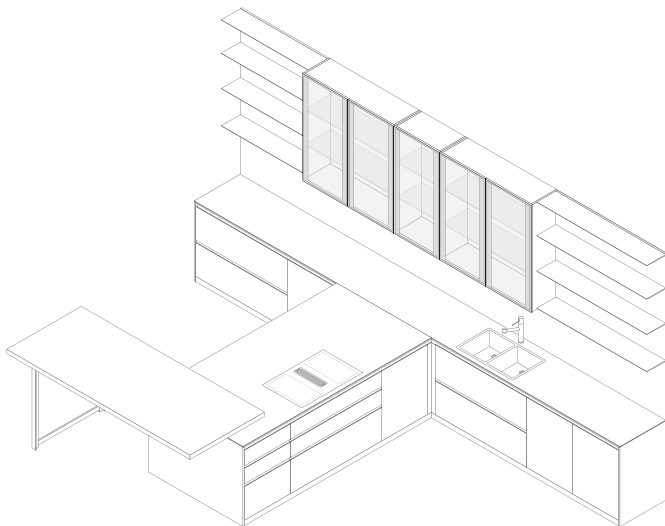

Prime is designed to express the full potential of a kitchen featuring recessed opening. It comes in a range of different compositions designed to meet the most sophisticated aesthetic demands. The finger recess runs seamlessly the length and breadth of the product and ends on the side panels, an alternative solution to the finished sides, offering ample scope for personalization.

The Prime door is shaped at the top at 45° to make opening simpler and more ergonomic. The project also presents a new glass door for Flair wall units and columns, both lit with concealed LED profiles in the sides of the units, and the new Wing system with tapered aluminium shelves.



### FINISHES

#### Peninsula

Clay glossy lacquered base units, sandblasted brushed Billiemi Stone worktop, side panel and Splashback  
Pewter finger recess and skirting,  
Dark walnut Prime Snack table with pewter structure  
Bronze glass doors Flair wall units and pewter profiles  
Columns Bronze glass doors flair columns, Pewter profiles



### PLUSES

- Simple and intuitive design
- Design sobriety and project versatility
- Shaped upper door profile with 45° cut to maximize the ergonomic grip
- Dedicated inclined finger recess profile
- Transversal finish options
- Tailor made details for a complete customization of the project
- Shaped top and sides as optional
- Maxxigloss® finish

### Finger recess opening kitchen



H. unit structure = 828 mm

H. door = 797 mm

**H. kitchen with 60 mm skirting = 888 mm**

**H. kitchen with 100 mm skirting = 928 mm**

door th 19 mm

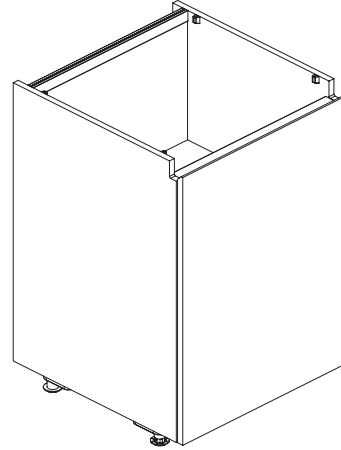

Horizontal finger recesses are used to open doors, drawers and pan drawers without handles. The finger recess can be selected as an opening method also for lower drawers and pan drawers. Available finishes are Titan, Pewter, Bronze or matt lacquer in range colours.

**A**  
First front opening on top

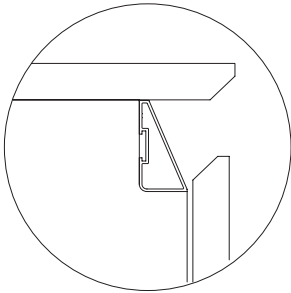

**B**  
Option with finger recess

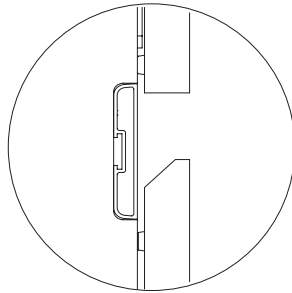

**C**  
Option with push-pull

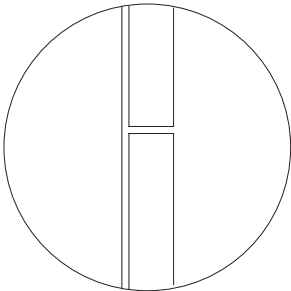

#### FINISHES

Titan

Pewter

Bronze

Matt lacquer in range colours



### End panels

Finished side panel: the profile of the finger recess ends against the structural side panel of the case, leaving the internal face visible.

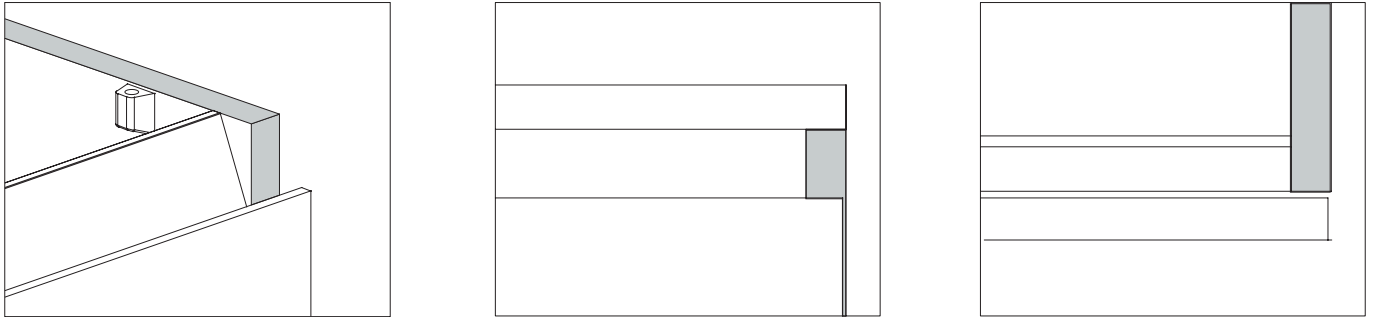

Additional end panel with square cross section, th 19 mm. Not compatible with shaped top. The end panel will have the same height as the case+skirting.

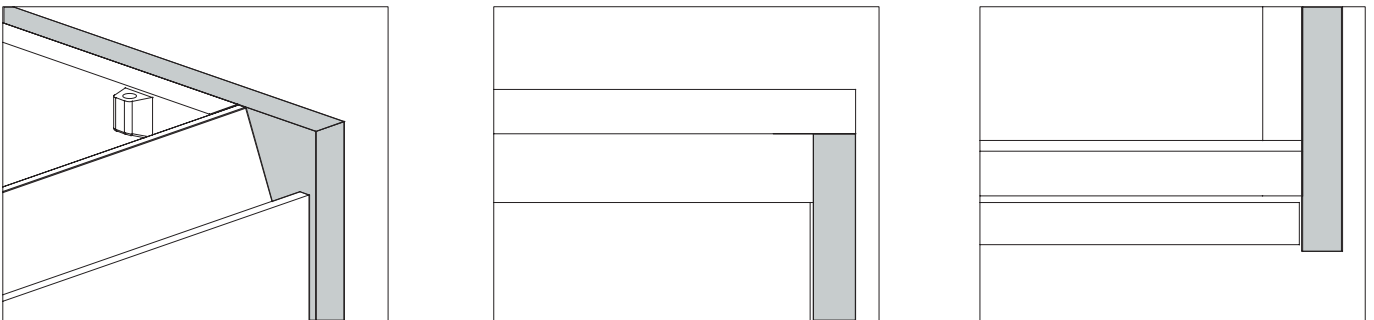

Shaped additional end panel, complete with finishing profile in aluminium, available in Titan, Pewter, Bronze finish. Not compatible with shaped top. The end panel will have the same height as the case + skirting.

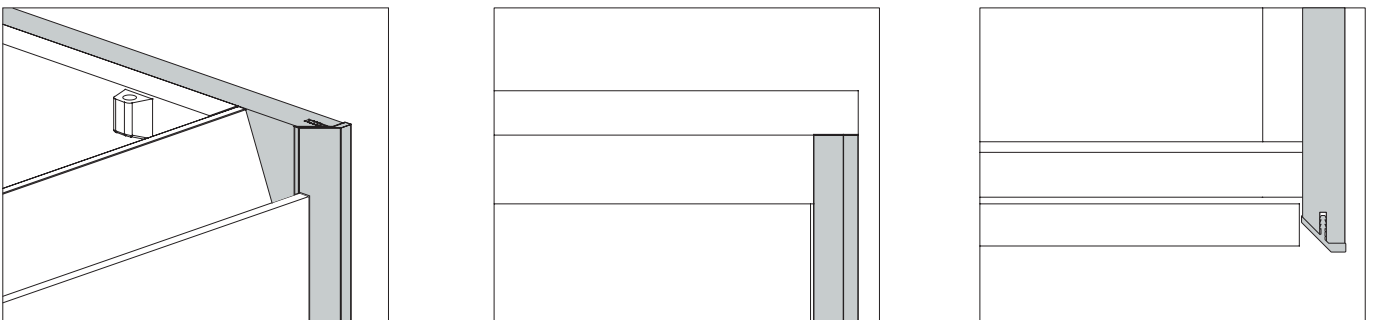

The additional end panel and the work top are bot shaped to joint to one another. It is mandatory for the top and end panel to be made of the same material.

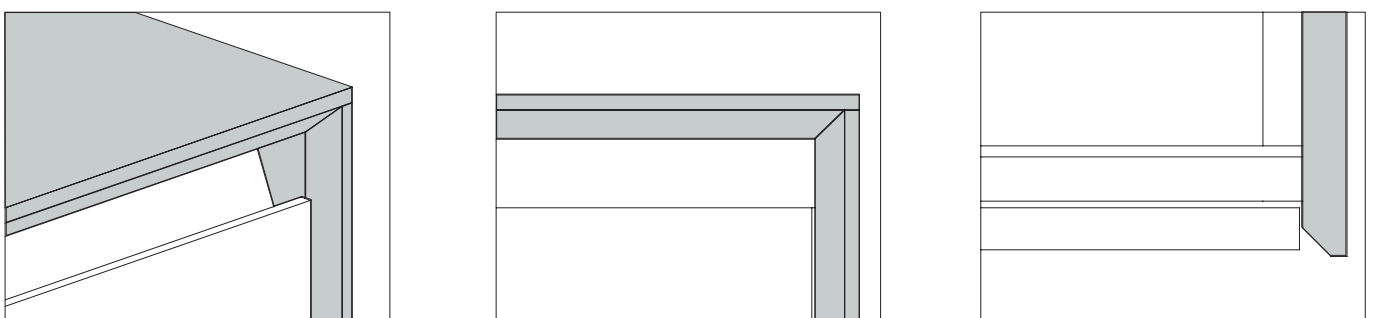

## PRIME

### Worktop

Shaped door th 19 mm

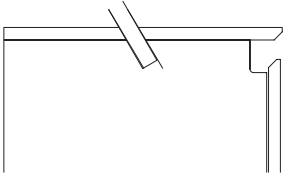

Wall composition

structure	worktop
331	356
595	620
745	770

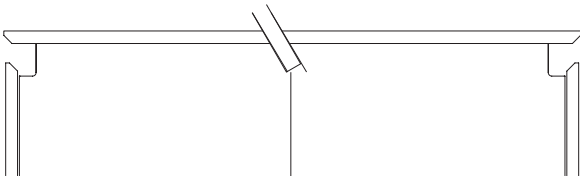

Island composition

structure	worktop
595	645
745	745
331 + 595	976
331 + 745	1126
595 + 595	1240

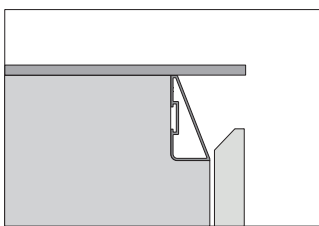
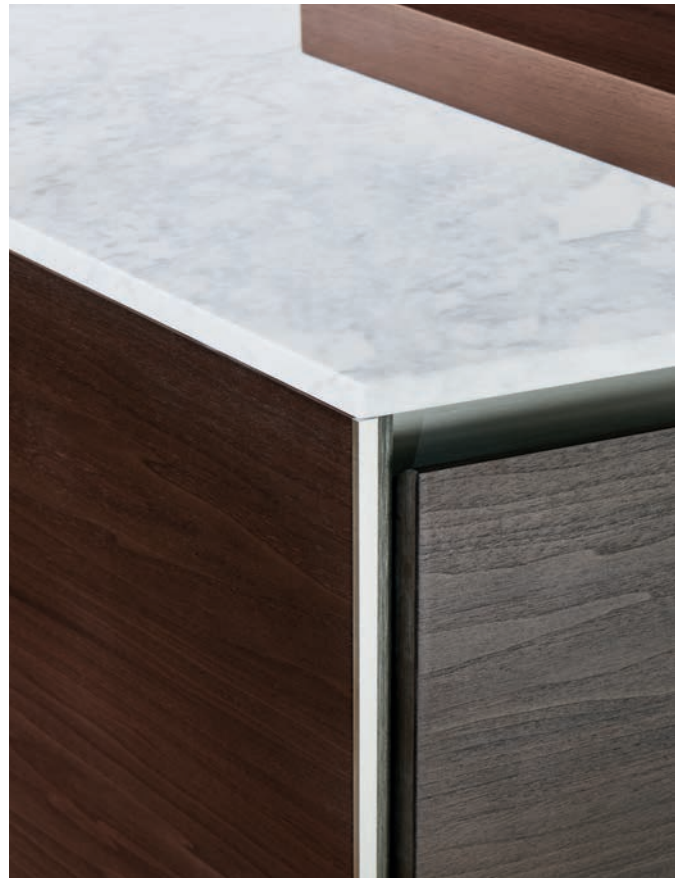

th 6 mm  
**FINISHES**  
 Stainless steel

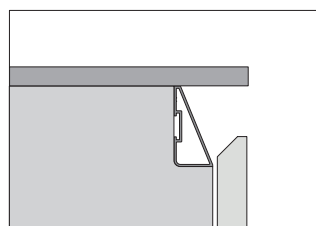

th 12 mm  
**FINISHES**  
 Ceramic  
 Steel  
 Glass

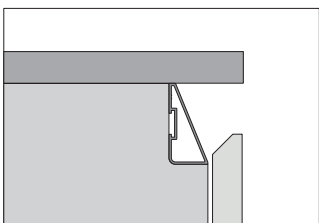

th 20 mm  
**FINISHES**  
 Laminato  
 Fenix®  
 Stones  
 Silestone  
 Dekton  
 Cartapietra  
 Corian®  
 Steel

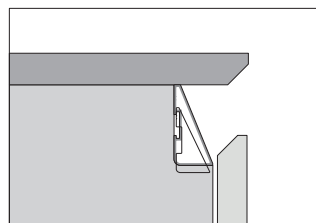

th 20 mm shaped  
**FINISHES**  
 Laminato  
 Fenix®  
 Stones  
 Silestone  
 Dekton  
 Cartapietra  
 Corian

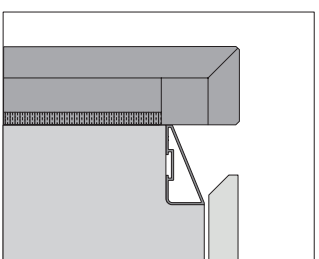

th 50 mm  
**FINISHES**  
 Laminato  
 Fenix®  
 Stones  
 Silestone  
 Dekton  
 Cartapietra  
 Corian®  
 Steel

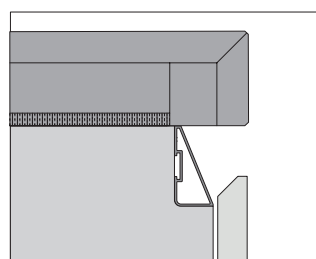

th 60 mm  
**FINISHES**  
 Stones

### Prime snack — th 50 mm

The snack Prime top is made of honeycomb reinforced panels, and is available with a laminated, fenix coloured, and wood finish. It is designed to be made to fit in with base unit support compositions, combined with its own custom support.

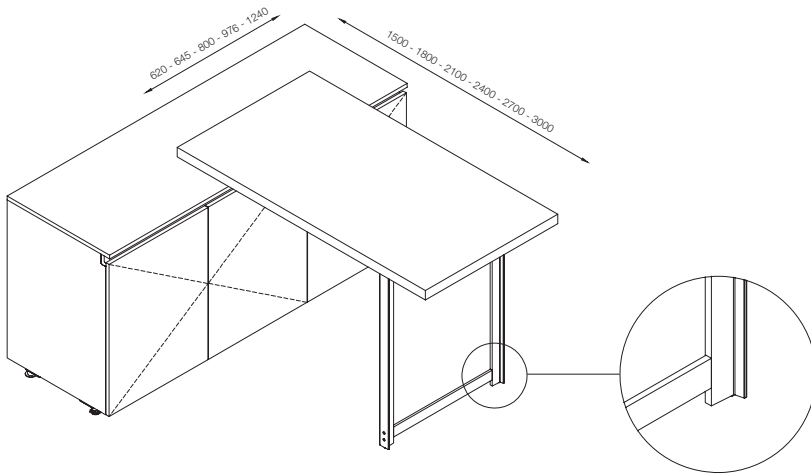

### Frame

A strongly aesthetic accessory, designed to support the snack Prime top, when combined with a projecting table. Height is adjustable to suit the height of the skirting and the top chosen, and easy to personalise in terms of dimensions.

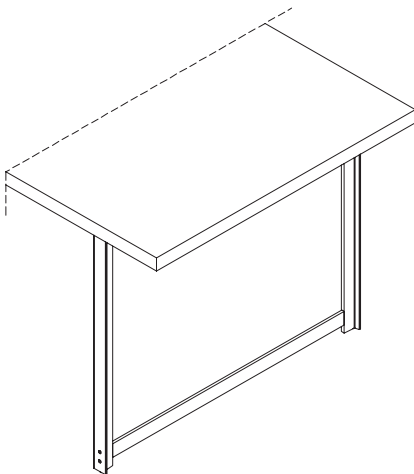

#### WORKTOP FINISHES

Woods  
Fenix®  
Laminate

#### STRUCTURE FINISHES

Pewter  
Bronze  
Titan

### Compositions



#### FINISHES

**PRIME**  
 slate structure  
 clay glossy lacq. doors  
 clay glossy lacq. fillers  
 billiemi marble shaped side panels,  
 shaped top th.20, backsplash  
 pewter "wing" lighting bar and shelves  
 clay etched glass back panels

**"FLAIR" GLASS WALL UNITS**  
 pewter horizontal finger recess  
 pewter skirting h.60  
 graphite oak snack with pewter support  
 all base units with led lighs

**PRIME COLUMNS**  
 slate structure  
 clay glossy lacq.  
 doors and extention units  
 clay glossy lacq. side panels  
 with pewter profile  
 pewter vertical finger recess  
 pewter skirting h.60

**FLAIR GLASS COLUMNS**  
 slate structure  
 pewter frame door with bronze glass  
 clay glossy lacq. side panels  
 with pewter profile  
 clear glass shelves  
 pewter vertical finger recess  
 pewter skirting h.60  
 integrated led light on sides  
 remote controle

**FLAIR GLASS WALL UNITS**  
 slate structure  
 pewter frame door with bronze glass  
 clear gloss shelves  
 integrated led light on sides  
 remote controle

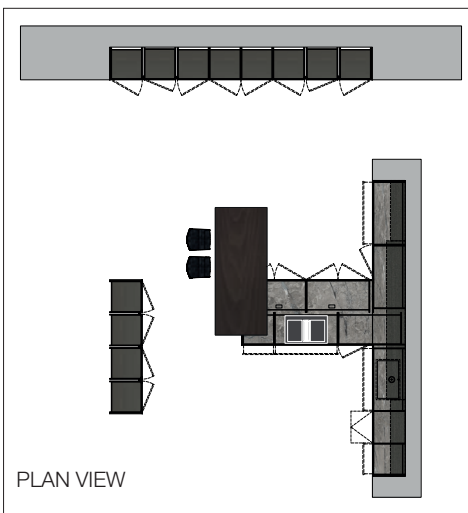

#### FRONT VIEW

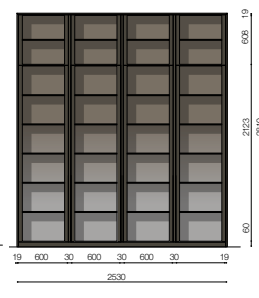
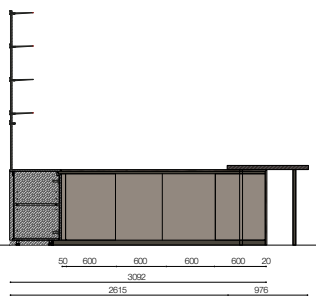
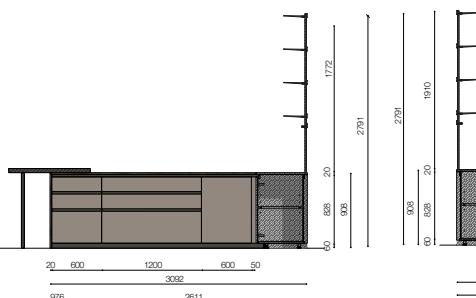
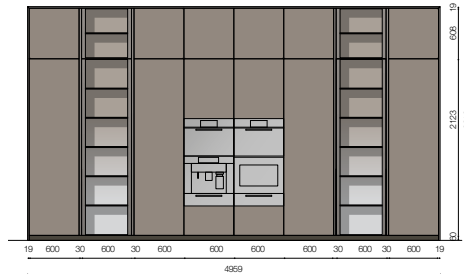
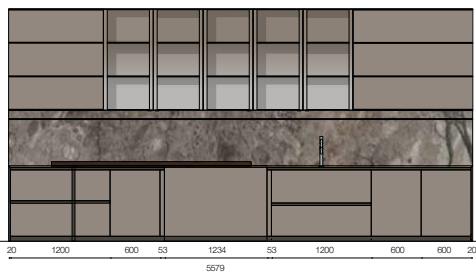

DOWNLOAD THE 2D/3D FILES

## PRIME

### Modularity

MODULE	LENGTH	HEIGHT	DEPTH	DOOR THICKNESS	DOOR THICKNESS WITH HANDLE
BASES	300 450 600 900 1200*	828	331 595	19	

### Door finishes

#### LM BILAMINATES | PRICE RANGE 1

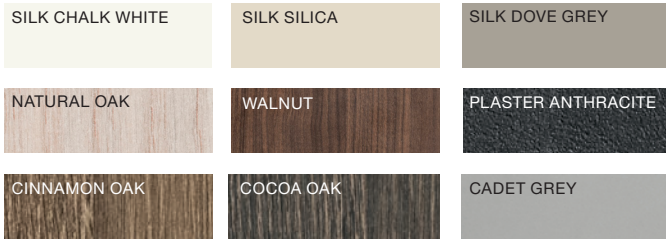

#### LM BILAMINATES HQ | PRICE RANGE 2

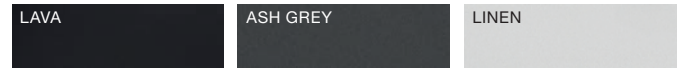

#### LX FENIX® NTM | PRICE RANGE 4



#### MX MAXXIGLOSS® | PRICE RANGE 2

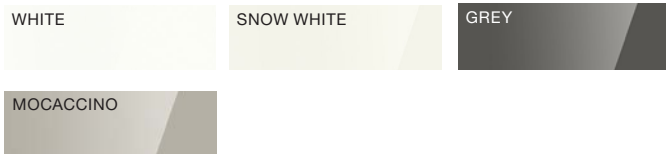

#### LP LAMINATES | PRICE RANGE 2



#### L0, LL LACQUERED | PRICE RANGE 5/7



#### ES WOODS | PRICE RANGE 6

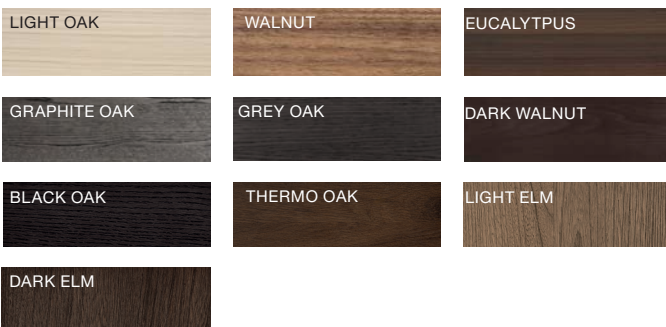

#### ES WOODS | PRICE RANGE 7

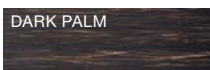

#### LX FENIX® NTA | PRICE RANGE 7

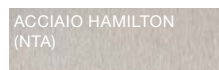

#### LSH SPECIAL LACQUERED | PRICE RANGE 7



#### LS SPECIAL LACQUERED | PRICE RANGE 6

