

Molteni & C

OCTAVE — VINCENT VAN DUYSSEN 2020

1—
9



Octave is a system of modular sofas featuring rigorous shapes. A design marked by geometrical lines, based on mix & match modular elements that came together in linear, angular compositions or with the addition of hanging trapezoidal or rectangular elements in unusual and highly appealing configurations. Blade-like extruded steel legs support the base on which rest low rectangular fabric or leather upholstered backrests, of the same thickness as the cosy seat cushions. Guaranteeing the utmost comfort, complementary cushions, again rectangular or square, along with the headrest that can be freely positioned on the backrest, enabling it to be used in various positions. In addition to the traditional linear or corner elements, Octave offers open elements with which to create chaises longues or poufs that can be arranged alongside the composition or used as free-standing elements, also for the centre of the room. The conjoining rectangular or trapezoidal elements feature innovative hide leather trays on which to place all kinds of objects. Thanks to the possibility of creating articulated compositions, Octave is ideal in a “smart working” environment via the use of binding components designed to support laptops and tablets.



This symbol shows that the product has removable upholstery. Only qualified personnel can remove the upholstery of some of our products. If this information is pertinent, it will be included in the warnings section.



This symbol shows that the product is available on request in a fire resistant version that complies with the standards BS 5852 and TB 117-2013. The buyer is responsible for checking to make sure that the product is suitable and compliant with the requirements for the designated use and the current applicable laws and standards for the destination and use of the product.

DATASHEET

REGISTERED
DESIGN

IX.2023

FINISHES

BASE FINISHES

painted zinc - painted pewter colour

BONDED HIDE LEATHER FINISHES

ivory - black - dark brown -
natural - mud green - dove grey

TECHNICAL INFORMATION

INTERNAL STRUCTURE

Frame made of solid Firwood (Picea abies) and wood particle panels with elastic straps.

STRUCTURE PADDING

High performance variable density polyurethane foam. Cover in bonded velveteen.

SEAT CUSHION

Insert in shaped polyurethane and sterilized feathers. Cover in 100% cotton.

BACKREST AND LOWER BACK SUPPORT CUSHIONS

Polyester fibre and sterilised down. Cover in 100% cotton.

HEADREST

Polyurethane foam with high bearing capacity. Cover in bonded velveteen.

TRINKET TRAYS

Hot-welded steel sheet covered in bonded hide leather in colours from the Molteni range.

FEET

In painted hot-welded steel with non-slip plastic ferrules.

REMOVABLE OUTER COVER

(See enclosed sheet, specific for the cover in question).



AVAILABLE IN FIRE-RESISTANT
VERSION TB117 AND BS5852

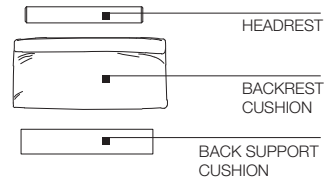
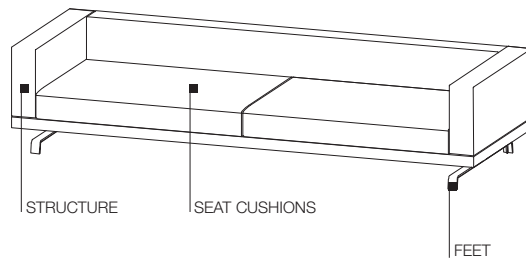

HEADREST



CORNER SHELF

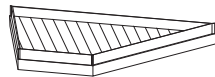

TRINKET TRAYS

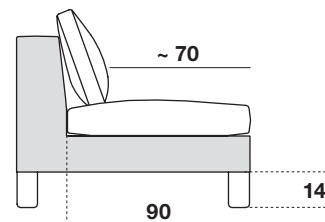
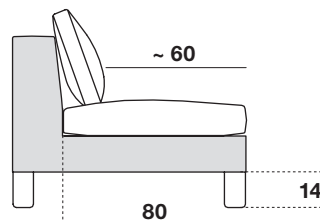
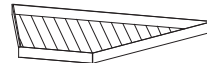
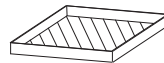

DATASHEET

REGISTERED
DESIGN

IX.2023

DEPTH 95 cm

Seat depth for structure only, 80 cm

Seat depth with backrest cushion, ~ 60 cm

Feet height 14 cm (from ground to under seat)

DEPTH 105 cm

Seat depth for structure only, 90 cm

Seat depth with backrest cushion, ~ 70 cm

Feet height 14 cm (from ground to under seat)

Dimensions in centimeters and inches. The right to discontinue and make changes is reserved. This information is based on the latest product information available at the time of printing.

NOTES

- ▶ List codes with **final A:**
Depth 105 cm.
- ▶ List codes with **final C:**
Depth 95 cm.
- ▶ **For correct ergonomics and maximum comfort, we recommend designing each module with a backrest cushion, headrest and lower back support cushion, in accordance with the pairings/measurements suggested in the price list. In addition to correct ergonomics, the presence of these elements makes the product look complete and elegant.**
- ▶ **ATTENTION:**
The trinket trays cannot be ordered individually but only combined with the modules provided in the price list.
- ▶ **The corner shelf must always be used with one padded element on the right and another on the left.
The corner shelf cannot be used as an end/final element.**

When ordering

Specify the measurements of backrests, headrests and back support cushions.

Molteni & C

3—
9

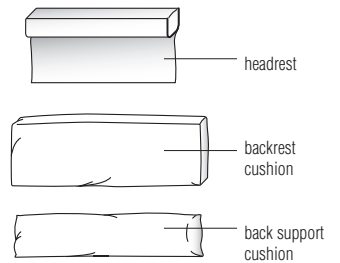
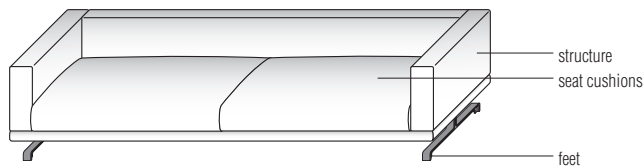

Corner shelf

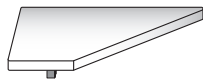

Trinket trays

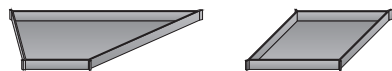

DATASHEET

REGISTERED
DESIGN

IX.2023

DIMENSIONS

Octave depth 95

Molteni & C

4—
9

sofa
DI270C

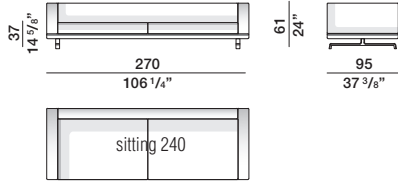

back cushion
W 120 - 47 1/4"

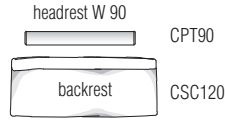

back cushion
W 105 - 41 3/8"

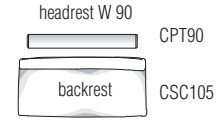

ornamental cushion
PCU90/75

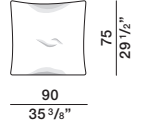

sofa
DI240C

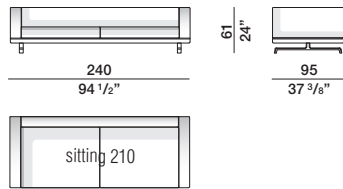

back cushion
W 105 - 41 3/8"

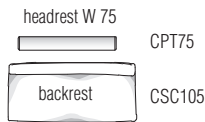

back cushion
W 90 - 35 3/8"

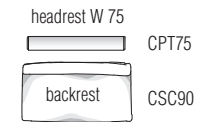

ornamental cushion
PCU90/75

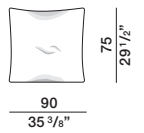

sofa
DI210C

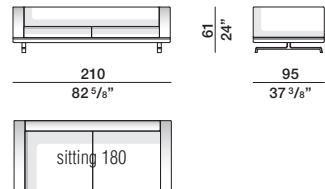

back cushion
W 90 - 35 3/8"

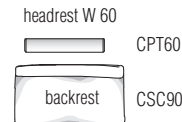

back cushion
W 75 - 29 1/2"

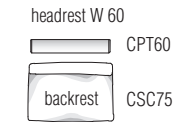

ornamental cushion
PCU90/75

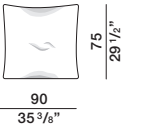

DATASHEET

REGISTERED
DESIGN

IX.2023

DIMENSIONS

Octave depth 105

Molteni & C

5—
9

sofa
DI270A

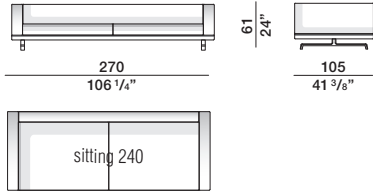

back cushion
W 120 - 47 1/4"

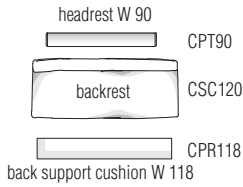

back cushion
W 105 - 41 3/8"

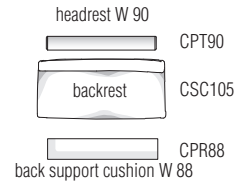

ornamental cushion
PCU90/75

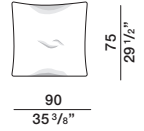

sofa
DI240A

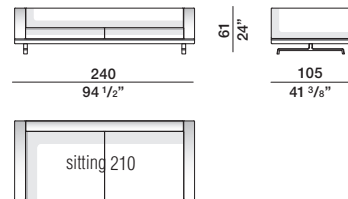

back cushion
W 105 - 41 3/8"

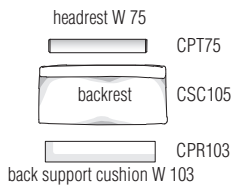

back cushion
W 90 - 35 3/8"

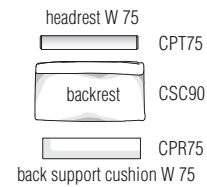

ornamental cushion
PCU90/75

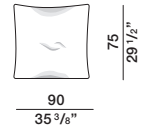

sofa
DI210A

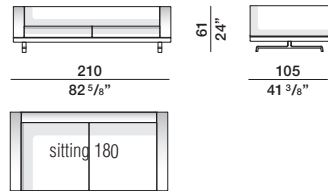

back cushion
W 90 - 35 3/8"

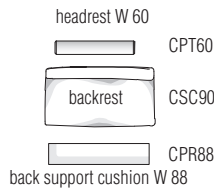

back cushion
W 75 - 29 1/2"

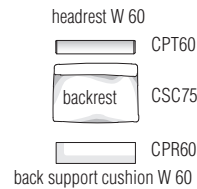

ornamental cushion
PCU90/75

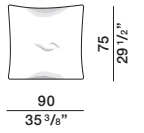

end element
TE255A dx - sx

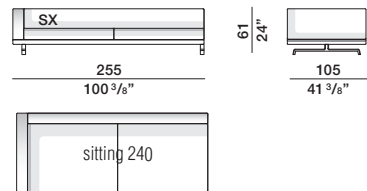

back cushion
W 120 - 47 1/4"

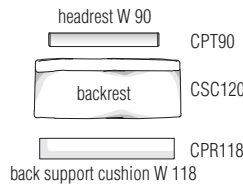

back cushion
W 105 - 41 3/8"

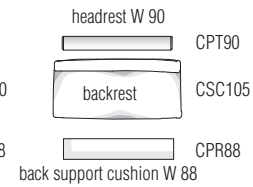

ornamental cushion
PCU90/75

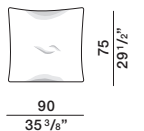

end element
TE225A dx - sx

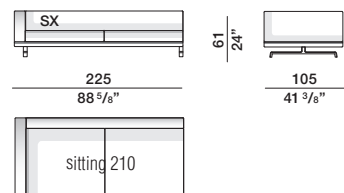

back cushion
W 105 - 41 3/8"

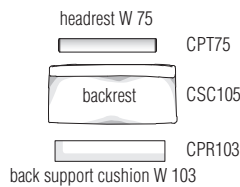

back cushion
W 90 - 35 3/8"

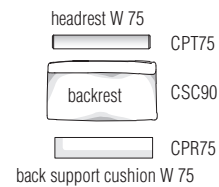

ornamental cushion
PCU90/75

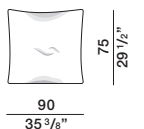

DATASHEET

REGISTERED
DESIGN

IX.2023

DIMENSIONS

Octave depth 105

end element
TE195A dx - sx

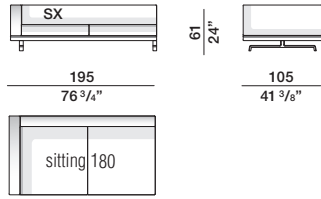

end element
TE135A dx - sx

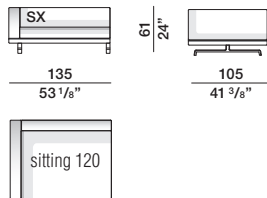

end element with tray (60x90)
TV255A dx - sx

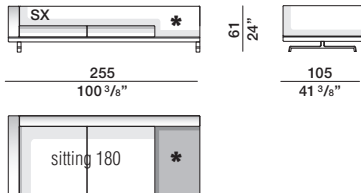

end element with tray (60x90)
TV195A dx - sx

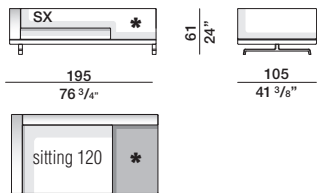

central element
CT210A

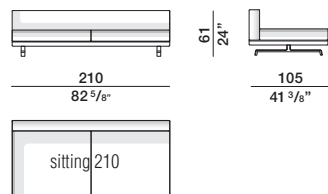

back cushion
W 90 - 35 3/8"

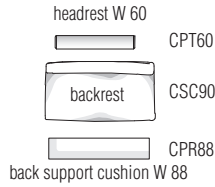

back cushion
W 120 - 47 1/4"

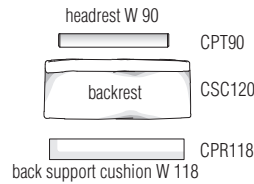

back cushion
W 90 - 35 3/8"

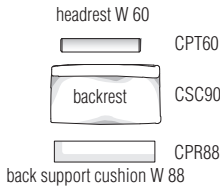

back cushion
W 120 - 47 1/4"

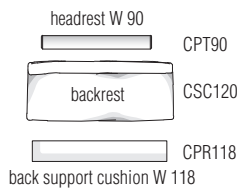

back cushion
W 105 - 41 3/8"

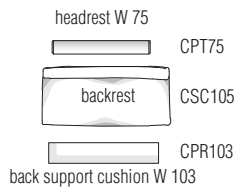

back cushion
W 75 - 29 1/2"

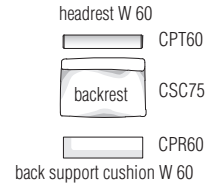

back cushion
W 105 - 41 3/8"

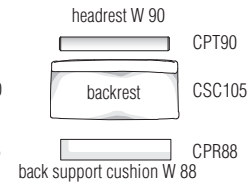

back cushion
W 75 - 29 1/2"

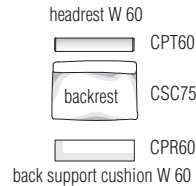

back cushion
W 105 - 41 3/8"

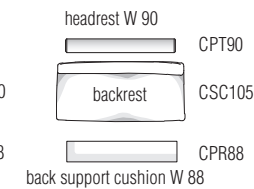

back cushion
W 90 - 35 3/8"

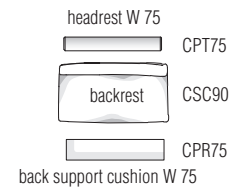

ornamental cushion
PCU90/75

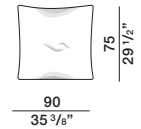

ornamental cushion
PCU90/75

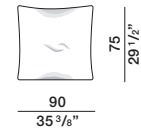

ornamental cushion
PCU90/75

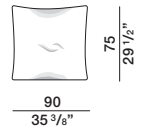

ornamental cushion
PCU90/75

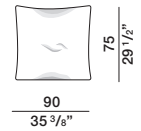

ornamental cushion
PCU90/75

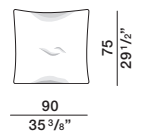

DATASHEET

REGISTERED
DESIGN

IX.2023

DIMENSIONS

Octave depth 105

central element
CT180A

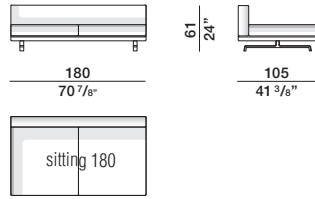

back cushion
W 90 - 35 3/8"

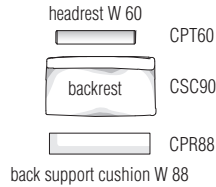

back cushion
W 75 - 29 1/2"

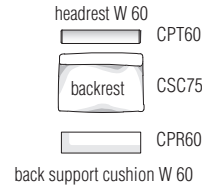

ornamental cushion
PCU90/75

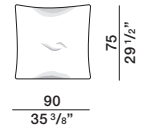

central element
CT120A

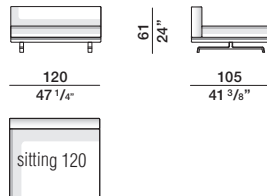

back cushion
W 120 - 47 1/4"

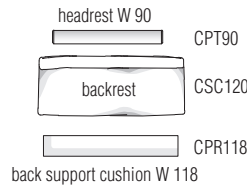

back cushion
W 105 - 41 3/8"

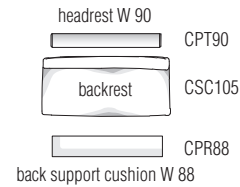

ornamental cushion
PCU90/75

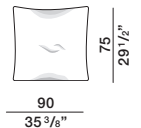

island element
IS150A dx - sx

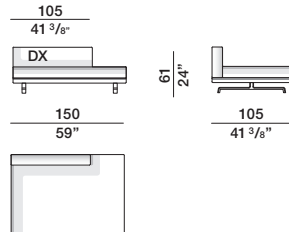

back cushion
W 105 - 41 3/8"

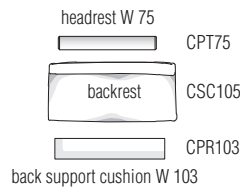

back cushion
W 90 - 35 3/8"

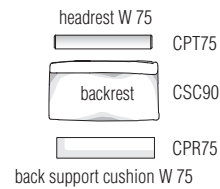

ornamental cushion
PCU90/75

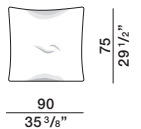

island element with tray (60x90)
IV240A dx - sx

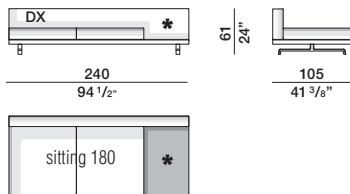

back cushion
W 90 - 35 3/8"

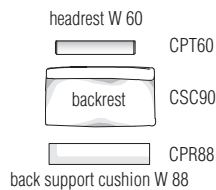

back cushion
W 75 - 29 1/2"

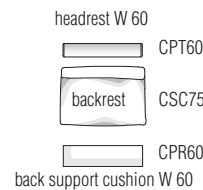

ornamental cushion
PCU90/75

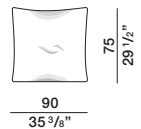

island element with tray (60x90)
IV180A dx - sx

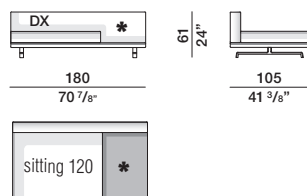

back cushion
W 120 - 47 1/4"

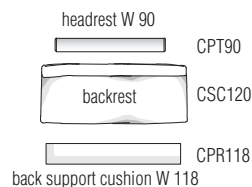

back cushion
W 105 - 41 3/8"

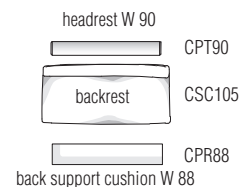

ornamental cushion
PCU90/75

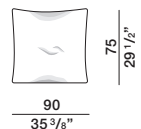

DATASHEET

REGISTERED
DESIGN

IX.2023

DIMENSIONS

island element with tray (60x90)
IV150A dx - sx

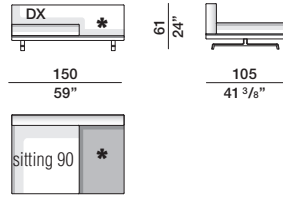

chaise longue
CL105 dx - sx

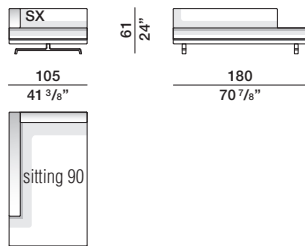

daybed
DB105

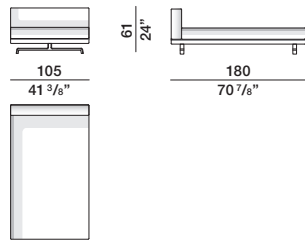

corner island element
IA224A dx - sx

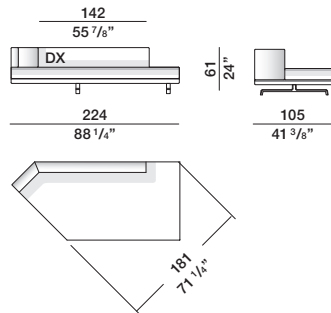

pouf
PF105A

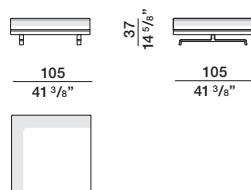

back cushion
W 90 - 35 3/8"

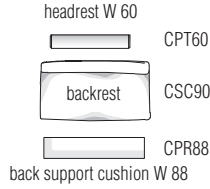

back cushion
W 90 - 35 3/8"

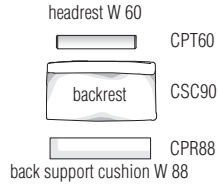

back cushion
W 105 - 41 3/8"

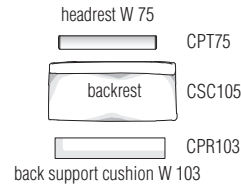

back cushion
W 120 - 47 1/4"

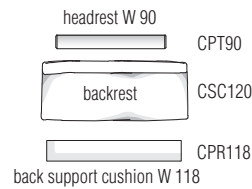

back cushion
W 75 - 29 1/2"

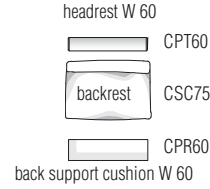

back cushion
W 75 - 29 1/2"

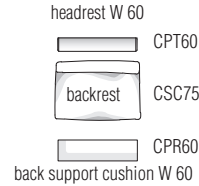

back cushion
W 90 - 35 3/8"

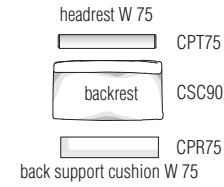

back cushion
W 105 - 41 3/8"

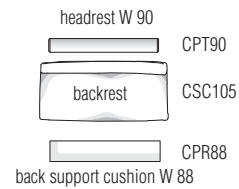

ornamental cushion
PCU90/75

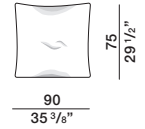

ornamental cushion
PCU90/75

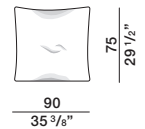

ornamental cushion
PCU90/75

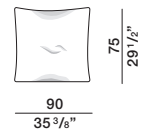

DATASHEET

REGISTERED
DESIGN

IX.2023

DIMENSIONS

corner shelf

AME2

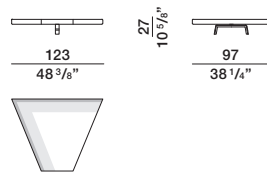

Molteni & C

trinket tray

AVP1

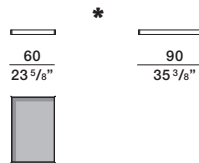

trinket tray

AVP2

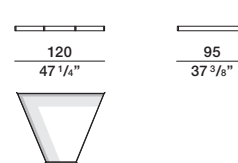

9—
9

code	gross weight kg.	volume mc.	packages	code	gross weight kg.	volume mc.	packages
DI270C	139	2,3	1	CT210A	110	1,8	1
DI240C	130	2,1	1	CT180A	82,8	1,5	1
DI210C	120	2	1	CT120A	60	1,1	1
DI270A	139	2,3	1	IS150A	82	1,4	1
DI240A	130	2,1	1	IV240A	117	2	1
DI210A	120	2	1	IV180A	91	1,6	1
TE255A	145	2,3	1	IV150A	85	1,4	1
TE225A	127	2,15	1	CL105	96	1,59	1
TE195A	112	1,8	1	DB105	90	1,5	1
TE135A	88	1,4	1	IA224A	106	2	1
TV255A	130	2,22	1	PF105A	49	0,7	1
TV195A	109	1,85	1	AME2	29	0,38	1

DATASHEET

REGISTERED
DESIGN

IX.2023