

EDMOND — CHRISTOPHE DELCOURT 2026

1—
5



Il sistema di divani componibili Edmond nasce come un esercizio di architettura domestica, in cui il comfort si fa espressione funzionale e la visione stilistica rimane in costante evoluzione. Lo schienale si modella, la profondità della seduta si calibra, suggerendo modalità d'uso sempre diverse senza mai imporle, lasciando spazio a un abitare libero e personale. Il piping a contrasto agisce come un filo conduttore, una linea tracciata a matita che attraversa il progetto. Un segno sottile ma eloquente, capace di mettere in evidenza appoggi, angoli, e punti di connessione, rendendo leggibile la costruzione e il disegno del volume. In Edmond, l'organicità delle forme incontra un rigore progettuale reso fluido. Il sistema modulare moltiplica le possibilità di vivere questo arredo, cuore pulsante di accoglienza, dove comfort, relazione e libertà compositiva trovano un equilibrio naturale.



Il simbolo indica che questo prodotto è dotato di rivestimento sfoderabile. In alcuni casi, il prodotto è sfoderabile, ma solo da personale qualificato; questa evenienza viene evidenziata nelle avvertenze.



Il simbolo indica che il prodotto è disponibile, su richiesta, in versione ignifuga in ottemperanza alle normative BS 5852 e TB 117-2013.

È responsabilità dell'acquirente verificare che il prodotto sia idoneo e conforme ai requisiti richiesti per la destinazione d'uso e alle normative vigenti nel luogo di destinazione e utilizzo del prodotto.

SCHEDA
TECNICA

REGISTERED
DESIGN

2026

INFORMAZIONI TECNICHE

INTERNO STRUTTURA SEDUTA

Telaio composto da legno massello di Abete (Picea abies) e pannelli di particelle di legno, con cinghie elastiche.

INTERNO STRUTTURA SCHIENALE

Telaio composto da pannelli di multistrato di legno.

IMBOTTITURA STRUTTURA SEDUTA

Poliuretano espanso ad alta portanza. Fodera in vellutino accoppiato cotone/fibra poliestere.

IMBOTTITURA STRUTTURA SCHIENALE

Poliuretano espanso a densità variabile e fodera in vellutino accoppiato cotone/fibra poliestere.

CUSCINI SEDUTA

Insero in poliuretano sagomato a densità variabile, fodera in cotone 100%.

CUSCINI SCHIENALE

Fibra di poliestere, fodera in cotone 100%.

PIEDINI

Acciaio verniciato con puntali antiscivolo in materiale plastico.

RIVESTIMENTO ESTERNO SFODERABILE

(Vedi scheda allegata, specifica del rivestimento).



PRODOTTO DISPONIBILE
IN VERSIONE CONFORME
A TB117 O BS5852

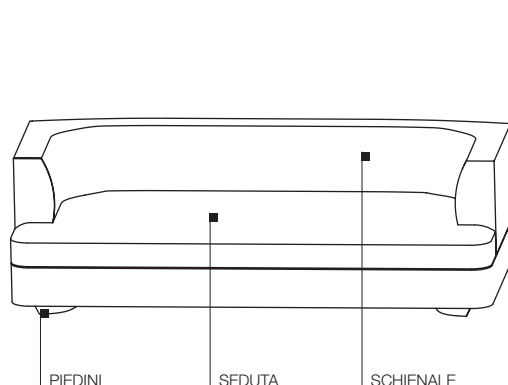

PIEDINI

SEDUTA

SCHIENALE

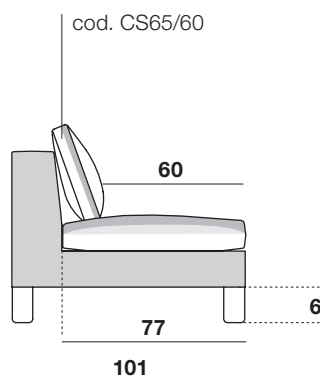

cod. CS65/60

60

77

101

6

Profondità di seduta solo struttura 77 cm
Profondità di seduta con cuscino schienale cod. CS65/60 cm 101
Altezza da pavimento a sotto divano 6 cm

AVVERTENZE

- Per la corretta ergonomia e per godere del massimo confort si consiglia di progettare ogni modulo utilizzando uno o più cuscini schienale, secondo le misure proposte a listino. Oltre alla corretta ergonomia la presenza di questi elementi conferisce al prodotto un aspetto estetico completo ed elegante.
- Le strutture ed i cuscini, sia nelle versioni in tessuto che nelle versioni pelle, sono confezionati con un profilo in grosgrain nei colori indicati nel capoverso finiture.

FINITURE

FINITURE GROSGRAIN
antracite
testa di moro
verde oliva
bianco carta
castoro
cuoio
ferro
nero
panna
sabbia
topo

DIMENSIONI

divano

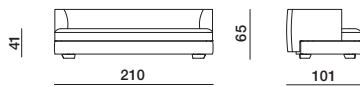

DI2110

divano

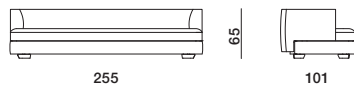

DI2510

terminale

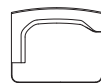

TL1210 dx-sx

terminale



TL1610 dx-sx

terminale



TL2110 dx-sx

**cuscin
schienale**



CS65/60

**cuscin
schienale**



CS45/45

**cuscin
schienale
ornamentale**

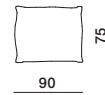

PCU90/75

**cuscin
schienale**



CS65/60

**cuscin
schienale**



CS45/45

**cuscin
schienale
ornamentale**

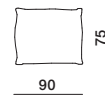

PCU90/75

**cuscin
schienale**



CS65/60

**cuscin
schienale**



CS45/45

**cuscin
schienale
ornamentale**

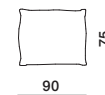

PCU90/75

**cuscin
schienale**



CS65/60

**cuscin
schienale**



CS45/45

**cuscin
schienale
ornamentale**

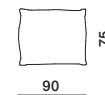

PCU90/75

**cuscin
schienale**



CS65/60

**cuscin
schienale**



CS45/45

**cuscin
schienale
ornamentale**

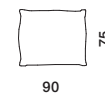

PCU90/75

DIMENSIONI

terminale curvo



TC2415 dx-sx

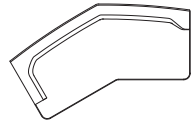

centrale

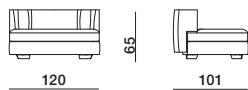

CE1210



centrale

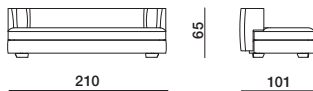

CE2110



chaise longue

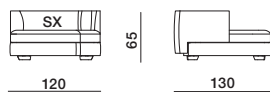

CL1213 dx-sx

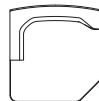

centrale

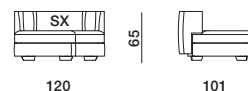

CA1210 dx-sx



**cuscin
schienale**



CS65/60

**cuscin
schienale**



CS45/45

**cuscin
schienale
ornamentale**

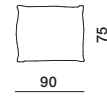

PCU90/75

**cuscin
schienale**



CS65/60

**cuscin
schienale**



CS45/45

**cuscin
schienale
ornamentale**

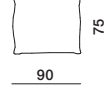

PCU90/75

**cuscin
schienale**



CS65/60

**cuscin
schienale**



CS45/45

**cuscin
schienale
ornamentale**

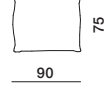

PCU90/75

**cuscin
schienale**



CS65/60

**cuscin
schienale**



CS45/45

**cuscin
schienale
ornamentale**

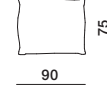

PCU90/75

**cuscin
schienale**



CS65/60

**cuscin
schienale**



CS45/45

**cuscin
schienale
ornamentale**

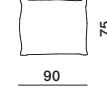

PCU90/75

DIMENSIONI

angolare grande

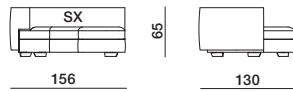

AN1513 dx-sx

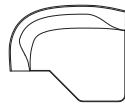

**cuscinò
schienale**



CS65/60

**cuscinò
schienale**



CS45/45

**cuscinò
schienale
ornamentale**

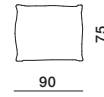

PCU90/75

isola



IS1810 dx-sx

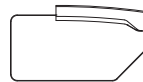

**cuscinò
schienale**



CS65/60

**cuscinò
schienale**



CS45/45

**cuscinò
schienale
ornamentale**

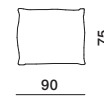

PCU90/75

angolo



AN1313



**cuscinò
schienale**



CS65/60

**cuscinò
schienale**



CS45/45

**cuscinò
schienale
ornamentale**

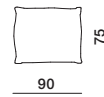

PCU90/75

angolare

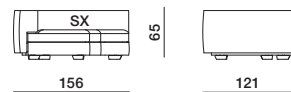

AN1512 dx-sx



**cuscinò
schienale**



CS65/60

**cuscinò
schienale**



CS45/45

**cuscinò
schienale
ornamentale**

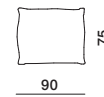

PCU90/75

pouf

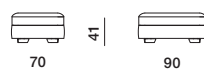

PF0709

