

Molteni & C

FONTE — VINCENT VAN DUYSSEN 2024

1—
3



Within the Fonte series, circular volumes meet refined craftsmanship, creating sophisticated lounge complements suitable for any setting. Resting on three vertical oak stained solid wood uprights, the circular base of the Fonte coffee tables showcases any one of a rich array of tabletop materials such as marble, essence, or black back-painted glass, offering versatility in design. The subdued hues of the tabletops harmonize with the coffee and black oak finishes, creating a delicate interplay of solidity and fluidity that exudes timeless charm. Completing the collection are a bedside table and a refined lounge table, each meticulously crafted to enhance functionality and style. The bedside table features a practical drawer and a sophisticated upper ring with an elegant burnished painted finish, while the lounge table offers a generous surface area. Described by Vincent Van Duysen as “key pieces with exquisite taste, enriched with unparalleled details,” the Fonte tables are versatile additions to any interior. Whether placed next to a sofa, in a central position for work or leisure, or as a bedside companion, these pieces effortlessly blend style with functionality. The Fonte series pairs elegantly with the Ovidio bed from the 2023 Collection for a cohesive and sophisticated look, reflecting Van Duysen’s vision of modern living.

DATASHEET

REGISTERED
DESIGN

IV.2024

FINISHES

STRUCTURE FINISHES

Stained solid wood:
coffee oak
black oak

GLASS TOP FINISHES

black back-painted clear

TOP FINISHES WOOD

coffee oak
black oak

MARBLE TOP FINISHES

Cat. M matt or glossy

black marquina
green alpine

Cat. S matt or glossy

calacatta
breccia capraia
red lepanto
Sahara noir
emperador dark

TECHNICAL INFORMATION

SMALL TABLES AND LOUNGE TABLE

STRUCTURE

Stained solid ash wood with thermoplastic feet.

WOOD TOP

20 mm thick medium-density fibreboard panel covered with oak veneer (Quercus).

MARBLE TOP

20 mm thick marble in the finishes indicated in the price list and specific for the model.

GLASS TOP

8 mm thick back-painted tempered glass.

BEDSIDE TABLE

STRUCTURE AND DRAWER FRONT

Stained solid ash wood with thermoplastic feet.

DRAWER SIDES AND BOTTOM

20 mm thick medium-density fibreboard panel covered with oak veneer (Quercus).

PERIMETER PROFILE

Painted aluminum.

MARBLE TOP

20 mm thick marble in the finishes indicated in the price list and specific for the model, with stain resistant and water-repellent treatment.

GLASS TOP

8 mm thick back-painted tempered glass.

SMALL TABLE

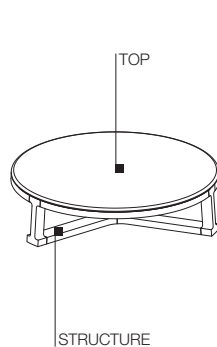

BEDSIDE TABLE

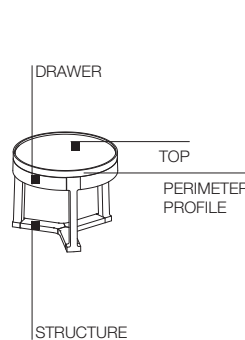

LOUNGE TABLE

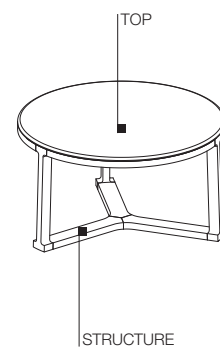

DATASHEET

REGISTERED
DESIGN

IV.2024

DIMENSIONS

Notes

No reductions of any kind or changes in finish are possible.

small table

H 30 - glass top
H 31 - wood/marble top

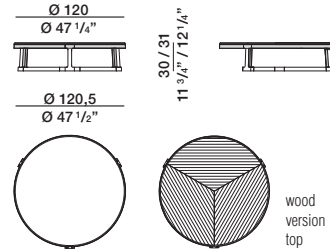

FTV4

small table

H 39,5 - glass top
H 40,5 - wood/marble top

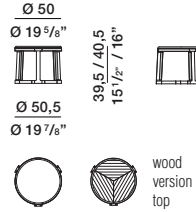

FTV2

small table

H 49,5 - glass top
H 50,5 - wood/marble top

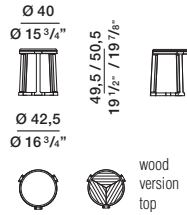

FTV1

bedside table

Ø 58 - effective space inside top

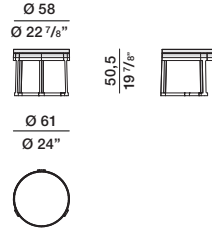

FCD1

lounge table

H 65 - glass top
H 66 - wood/marble top

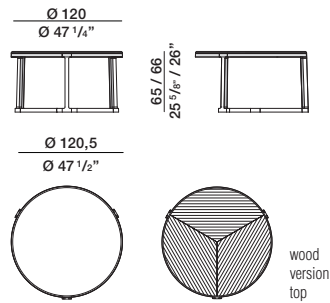

FTA1

DATASHEET

REGISTERED
DESIGN

IV.2024