

PASS-WORD EVOLUTION — DANTE BONUCCELLI 2014 / 2019 / 2021

1—
16



Pass-Word Evolution is the living system designed for the contemporary home. The design evolves drastically to perceive new ways of using the rooms of a contemporary house, inspired by multiple compositional and functional traits, combinations of full and empty volumes, which ensure extreme design freedom and an original expressive quality.

DATASHEET

REGISTERED
DESIGN

IX.2023

FINISHES

The drawer interior (sides and bottom) are faced in Batik melamine ecru or slate (specify when ordering).

* The doors and front pieces of drawers, matt and glossy lacquer colours, always have a handle in the same finish as the panel (pewter / iris metal handles, applicable on request without extra charge).

For wooden front pieces, on the other hand, a metal handle is available (pewter / iris), or a wooden handle.

finishes	Batik melamine	matt lacquer colours	woods	glossy lacquer colours	pewter colour / iris	lacquered matt anthracite	extra clear glass	transparent stopsol glass	marble	bronze glass
Floor standing bases / storage units / sideboards										
internal structure / drawer interior										
open compartment										
*wooden doors (hinged/lap/flush sliding)			*							
*wooden drawer fronts			*							
glass doors	frame									
	glass									
plinth										
metal base	feet									
	beam									
coverings									only upper	only upper
partitions										
front drawer interior										
Support shelf										
shelf										
rise with wire passage										
wall panel						matt lacquer				
undertop track										
Single shelf and shelf with back										
shelves / side cover										
back										
Vertical and horizontal hanging display cabinet										
base / top / back						matt lacquer				
side / door / shelves profiles										
door / side glass										
Grid-up wall unit										
tops th 30 mm										
back panel / central shelf / central partition										
glass door and glass side panel	profile									
	glass									

colours

Batik melamine

XE ecru

XA slate

Matt lacquer

BC chalk white
PE pearl
DN dune
PL platinum
NE black
AT anthracite
SE mustard
SI silica
DO dolomite grey
AL clay
MK moka
CZ light blue grey
SA sand
RU ruby
PX pewter colour
RX copper
TO dove grey
PR petroleum blue
BG burgundy
LS london sky
SU stardust
ML moonlight
SP spice
PG pine green
AW almond white

Glossy lacquer

BC chalk white
PE pearl
DN dune
PL platinum
NE black
AT anthracite
SE mustard
SI silica
DO dolomite grey
AL clay
MK moka
CZ light blue grey
SA sand
RU ruby
PX pewter colour
RX copper
TO dove grey
PR petroleum blue
BG burgundy
LS london sky
SU stardust
ML moonlight
SP spice
PG pine green
AW almond white

Woods

EU eucalyptus
RF graphite oak
RS sunrise oak
RC coffee oak

Marble

calacatta (special price)
black marquina
orient grey
green alpine
white Carrara

DATASHEET

REGISTERED
DESIGN

IX.2023

TYPES / DIMENSIONS

Floor standing bases H 320 (12 5/8") D 495 (19 1/2") - with plinth

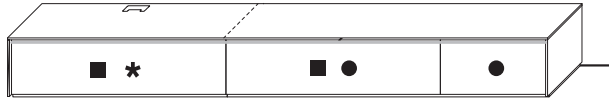

Floor standing bases H 450 (17 3/4") D 495 (19 1/2") - with metal base

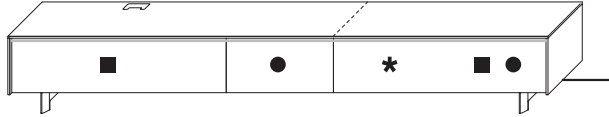

Legend

- = Flap door
 - = Drawers
 - ▲ = Hinged door
 - ◆ = Flush sliding door
 - * = Open compartment W 940/1100
- (the W 235/275 open compartments cannot be used as end units)

Floor standing storage units H 510 (20") D 495 (19 1/2") - with plinth

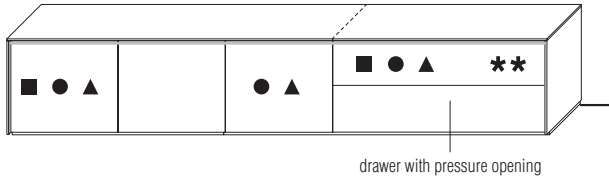

drawer with pressure opening

** Module with open compartment and drawer W 940 (37") / 1100 (43 1/4")

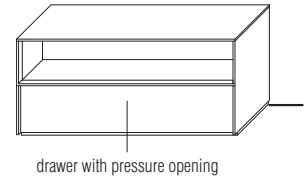

drawer with pressure opening

Floor standing storage units H 640 (25 1/4") D 495 (19 1/2") - with metal base

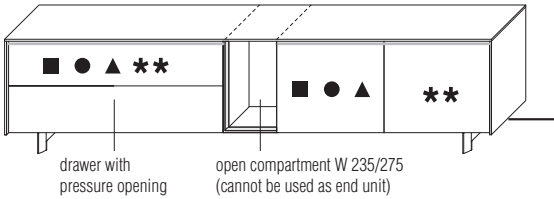

drawer with pressure opening

open compartment W 235/275 (cannot be used as end unit)

Floor standing sideboard H 630 (24 3/4") D 495 (19 1/2") - with plinth

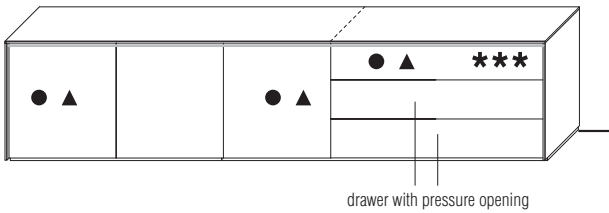

drawer with pressure opening

*** Module with open compartment and drawers or hinged doors W 940 (37") / 1100 (43 1/4")

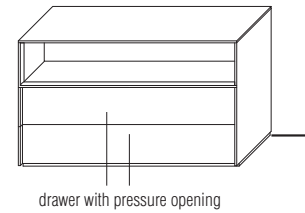

drawer with pressure opening

Floor standing sideboard H 760 (29 7/8") D 495 (19 1/2") - with metal base

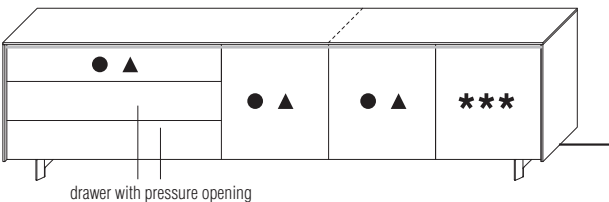

drawer with pressure opening

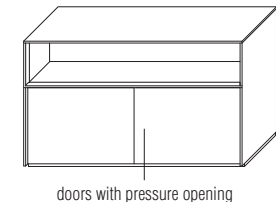

doors with pressure opening

DATASHEET

REGISTERED
DESIGN

IX.2023

TYPES / DIMENSIONS

Floor standing storage units with flush sliding doors H 640/760 (25 1/4" / 29 7/8") W 1900 (74 3/4") / 2220 (87 3/8") D 495 (19 1/2") - with metal base

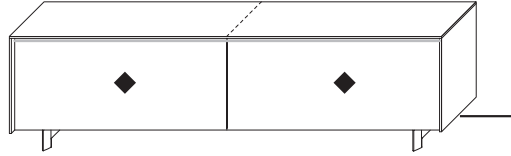

Molteni & C

Suspended storage units H 500 (19 3/4") D 385 (15 1/8")

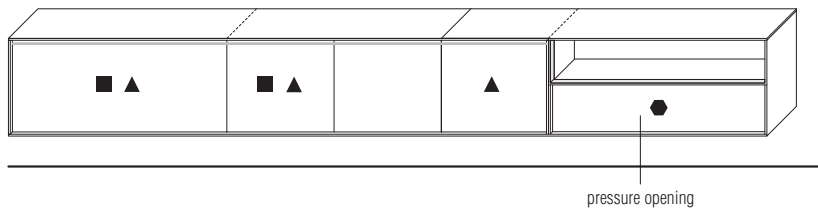

Legend

- = Module with open compartment and flap door W 940 (37") / 1100 (43 1/4")

4—
16

Suspended storage units H 310 (12 1/4") D 385 (15 1/8")

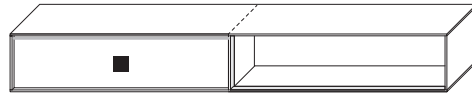

DATASHEET

REGISTERED
DESIGN

IX.2023

MODULARITY

Modularity of base/storage unit structures

Pass-Word Evolution base and storage unit structures, except for flush sliding models, can be used alone or set next to one another as shown in the diagram.

The upper and lower covering is complete and covers up to a width of 3000 mm.

Compositions with metal base can have a maximum length of 4420 mm.

In sizes from 2370 to 3320, the metal base has a central foot.

In sizes from 3390 to 4420, the metal base has two central feet.

No reductions of any kind are possible.

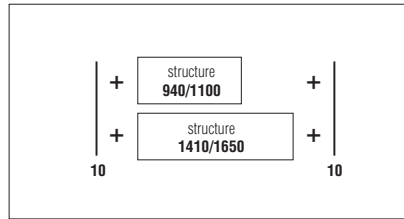

The W 470/550 structure can be set next to the W 1410/1650 structure (ex. **A**) or next to a module with an open compartment (ex. **B**) (ex. **C**).

Example A

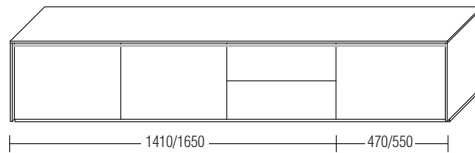

Example B

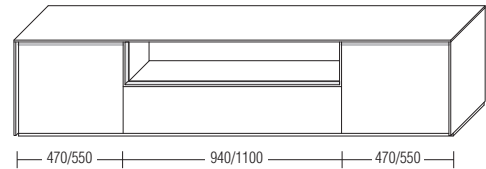

Example C

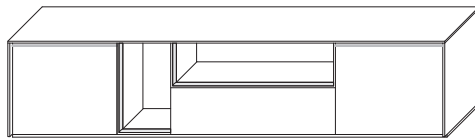

Example D

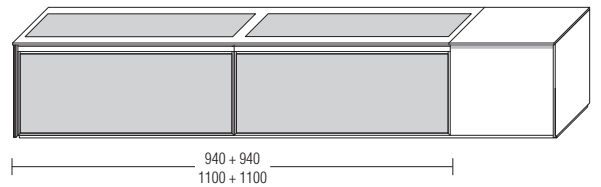

The structures with a glass top may be single or in same sized pairs (940 + 940 or 1100 + 1100)

The structures with W 470/550 can never be used alone or set together with other identical structures. They must only be set together with W 1410/1650 modules or modules with open compartment.

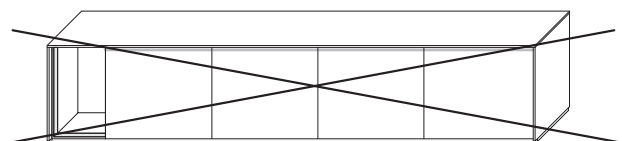
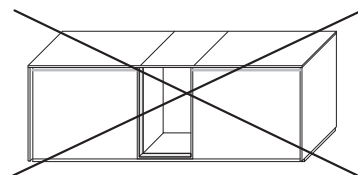
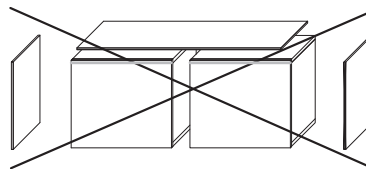
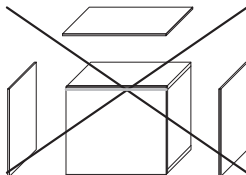

The W 235/275 open compartment can never be positioned outside of the composition.

DATASHEET

REGISTERED
DESIGN

IX.2023

TOP - JOINING METHOD

For worktops longer than 3000 mm, is it possible to make the joint as shown in the following examples.

In wood-finish compositions, the joint in the worktops will be assessed by the Molteni Technical Office in relation to the composition of the front piece.

GS
The covering is jointed in correspondence with the joints in the structures

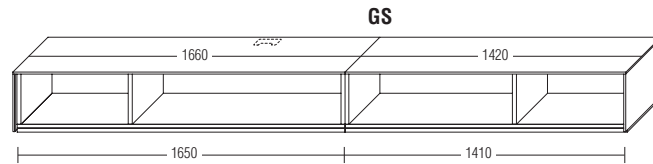

GCM
Covering joint at the centre of the unit (obtaining 2 pieces of the same size) - Example A
The central joint can only be made at the centre of W 940/1100 compartments
In wood-finish compositions, the joint in the worktops will be assessed by the Molteni Technical Office in relation to the composition of the front piece.

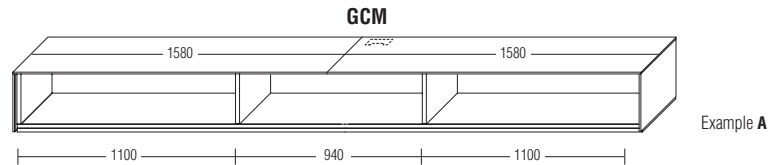

GCM
The covering is jointed at the halfway point of the central element W 940/1100 for non symmetrical compositions (we obtain 2 pieces that have almost the same measurements, as close as possible) - Example B
In wood-finish compositions, the joint in the worktops will be assessed by the Molteni Technical Office in relation to the composition of the front piece.

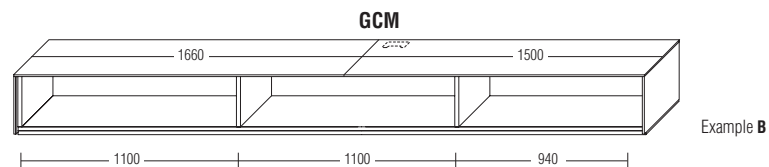

Examples with glass tops

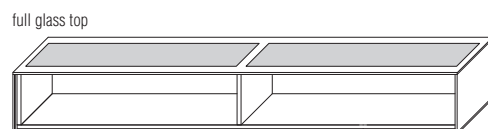
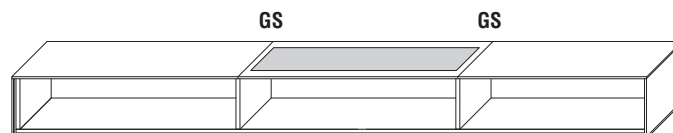
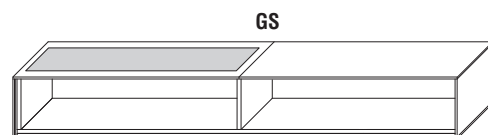

DATASHEET

REGISTERED
DESIGN

IX.2023

WEIGHT LIMITS

Suspended storage units D 385 (15 1/8") - H finished 310/500 (12 1/4" / 19 5/8")

Suspended storage units are made with structures in 2 heights: 290 (11 3/8") and 480 (18 7/8"). To complete the composition, it is obligatory to use the upper, lower and side coverings. It is possible to create open compartments with the specific element.

No reductions of any kind are possible.

The wall-mounted storage units never come with a bronze glass top.

The W 470 (18 1/2") / (550 (21 5/8")) structures can **never** be used alone or set together with other identical structures. They must only be set together with W 1410 (55 1/2") / 1650 (65") modules or modules with open compartments.

In wood-finish compositions, the joint in the worktops will be assessed by the Molteni Technical Office in relation to the composition of the front piece.

Molteni & C

7—
16

Structure for suspended storage units H 290 (11 3/8") / 480 (18 7/8")

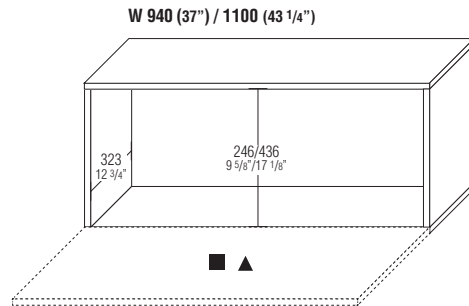

Max. load uniformly distributed

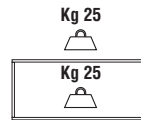

Legend

- = Flap door
- ▲ = Hinged door

Suspended storage units H 480 (18 7/8") with open compartment and flap doors

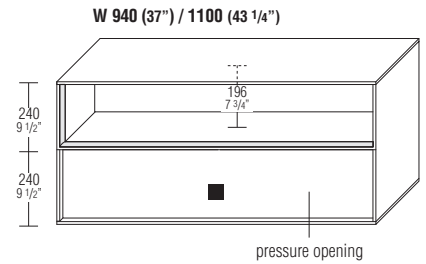

W 940 (37") / 1100 (43 1/4")

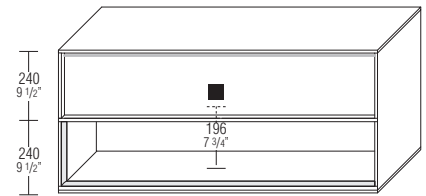

W 1410 (55 1/2") / 1650 (65") (only H 480) - SX version

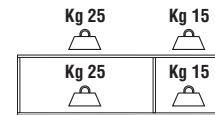
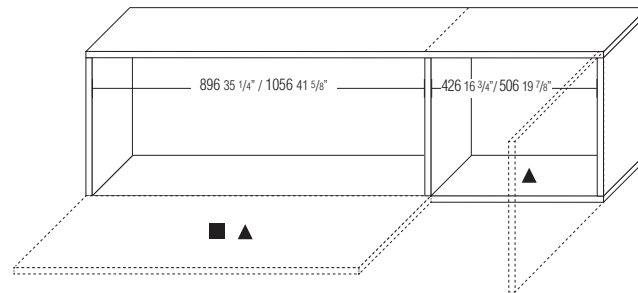

For the 1410 (55 1/2") / 1650 (65") module, when ordering, it is necessary to specify the right or left side version (determined by the 940 - 37" / 1100 - 43 1/4" compartment).

In the left version, the hinged door of the 470 (18 1/2") / 550 (21 5/8") compartment is always on the right, and vice versa.

Open compartments W 235 (9 1/4") / 275 (10 7/8")

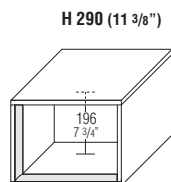

H 480 (18 7/8")

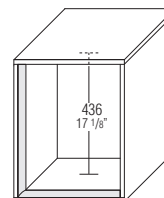

DATASHEET

REGISTERED
DESIGN

IX.2023

EXTERNAL LED LIGHTING SYSTEM FOR FLOOR-STANDING MODULES

- LED lights 3000°K
- Profiles with single light available up to a max length of 3000 mm. For longer lengths, we will supply two profiles joined half-way.
- Can be turned on using a connection to a controlled switch or with the (optional) remote control kit.
- For floor-standing structures, only the upper led is available.
- The external LED lighting system can be connected to the internal LED light of the structure with glass top using a single power supply unit, after checking the power in watts.

Floor-standing structures with external lighting system

The lighting system is made up of a frame with a horizontal LED holding profile and side profiles to be fixed to the structure.
See diagram below.

Molteni & C

8
16

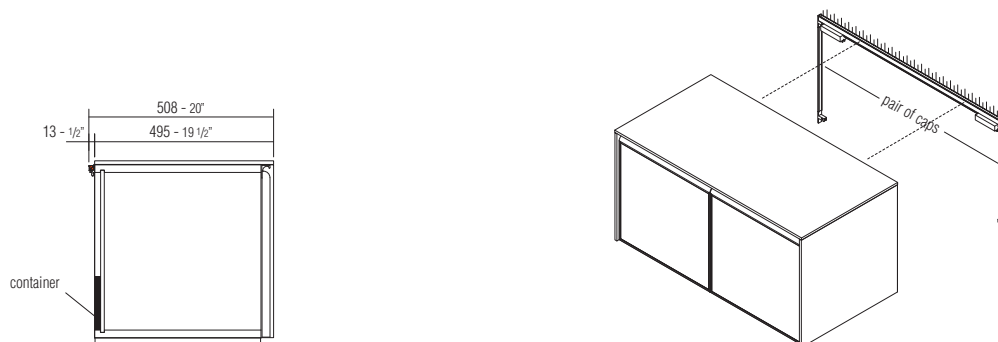

LED lighting system with smoked screen

max length 3000 mm
11W per lm

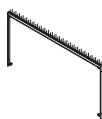

up to W 1120 **EST11** from 1130 to 1670 **EST16** from 1680 to 2220 **EST22** from 2230 to 2770 **EST27** from 2780 to 3000 **EST30**

each power supply unit can support LED bars up to 60 W

power supply unit 60W

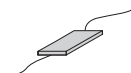

EAM1

connector
(1 for each composition up to 4 power supply units)



ECO1

radio control kit with brightness setting
(1 per power supply unit) optional



EKRR1

container



EVA1

Examples of compositions with external lighting - floor-standing modules

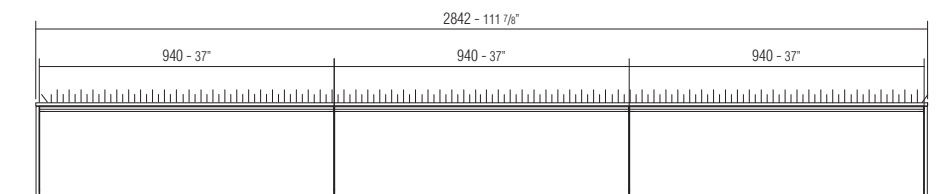

- no. 1 LED lighting system W 2842 mm (31,3 watt) **EST30**
- no. 1 power supply unit **EAM1**
- no. 1 connector **ECO1**
- no. 1 radio control kit **EKRR1**

DATASHEET

REGISTERED
DESIGN

IX.2023

EXTERNAL LED LIGHTING SYSTEM FOR WALL-MOUNTED MODULES

- LED lights 3000°K
- Profiles with full light available up to a max length of 3000 mm. For longer lengths, we will supply two profiles joined half-way.
- Can be turned on using a connection to a controlled switch or with the (optional) remote control kit.
- Wall-mounted structures can be fitted with a lighting system with 1 LED or 2 LEDs.
- The external LED lighting system can be connected to the internal LED light of the open compartment using a single power supply unit, after checking the power in watts.

Wall-mounted structures with external lighting system

Wall-mounted structures can be fitted with an upper and lower LED, or upper LED to be specified when ordering.

The lighting system is made up of a frame with 2 horizontal LED holding profiles and side profiles to be fixed to the wall before securing the composition.
See diagram below.

Molteni & C

9
16

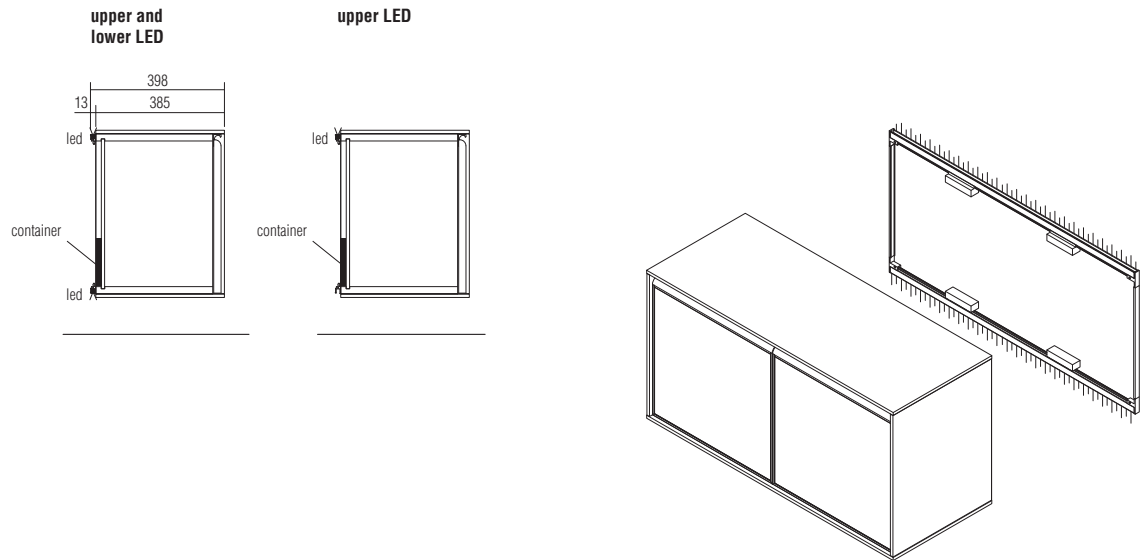

LED lighting system with smoked screen

max length 3000 mm
11W per lm for LED

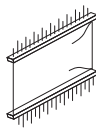

with upper
and lower light

up to W 1120
ESA11

from 1130 to 1670
ESA16

from 1680 to 2220
ESA22

from 2230 to 2770
ESA27

from 2780 to 3000
ESA30

DATASHEET

REGISTERED
DESIGN

IX.2023

moltenigroup.com

Dimensions in millimeters and inches. The right to discontinue and make changes is reserved. This information is based on the latest product information available at the time of printing.

EXTERNAL LED LIGHTING SYSTEM FOR WALL-MOUNTED MODULES

**LED lighting system
with smoked screen**
max length 3000 mm
11W per lm

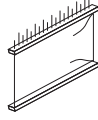

**with
upper light**

up to W 1120 **ESS11** from 1130 to 1670 **ESS16** from 1680 to 2220 **ESS22** from 2230 to 2770 **ESS27** from 2780 to 3000 **ESS30**

Molteni & C

each power supply unit
can support LED bars
up to 60 W

**power supply
unit 60W**

connector
(1 for each composition
up to 4 power supply units)

**radio control kit
with brightness
setting**
(1 per power supply unit)
optional

container

10 –
16

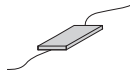

EAM1



EC01



EKRR1



EVA1

Examples of compositions with external lighting - wall-mounted modules

Composition with upper and lower LED

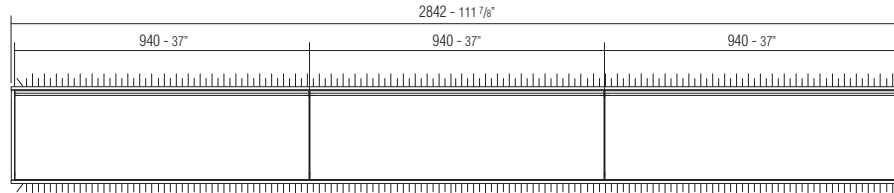

no. 1 LED lighting system **ESA30** (no. 1 LED W 2842 mm + no. 1 LED W 2842 mm) (62,5 watt)
no. 2 power supply units **EAM1**
no. 1 connector **EC01**
no. 2 radio control kit **EKRR1**

Composition with upper LED

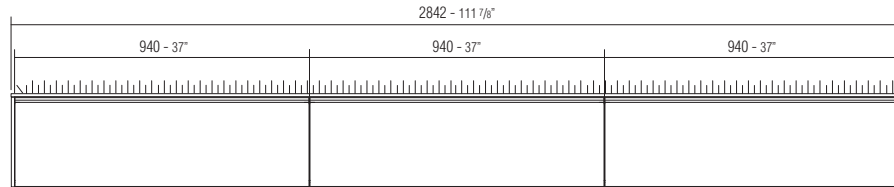

no. 1 LED lighting system W 2842 mm (31,3 watt) **ESS30**
no. 1 power supply unit **EAM1**
no. 1 connector **EC01**
no. 1 radio control kit **EKRR1**

DATASHEET

REGISTERED
DESIGN

IX.2023

SINGLE SHELVES

Wall fastening (with adjustments) takes place using special hidden brackets.
Plates must be anchored to the wall using state-of-the-art procedures on walls in masonry (solid wall or hollow brick).

The dealer is responsible for help in choosing the right tools to safely perform every type of operation and guarantee safety and capacity (**kg 15 per linear metre, uniformly distributed**).

We recommend a very scrupulous evaluation of the structural conditions of the wall prior to ordering and mounting the product.

Molteni&C is not responsible for mounting procedures that do not comply with the instructions above.

Shelves can be custom made in width (min. 950 / max. 2770) and cannot be reduced in depth.

Each shelf can, if required, be outfitted with an upper or lower LED lighting bar.

Please specify when ordering.

For the best installation result, we suggest providing electrical connections in the rear part as shown in the drawing below.

The removable front carter is provided with a compartment that can house power supply units, connector, and remote control kit.

Shelf finishes

pewter colour
iris

Molteni&C

11—
16

side section

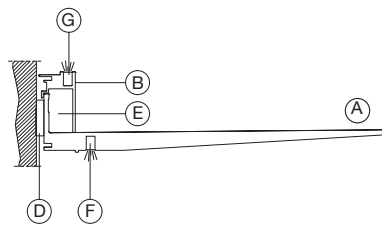

- (A) Shelf
- (B) Carter
- (C) Side closing plugs
(right-dx, sx-left)
- (D) Wall fastening bracket
- (E) Compartment containing
electrical components
- (F) Lower light (optional)
- (G) Upper light (optional)

front view

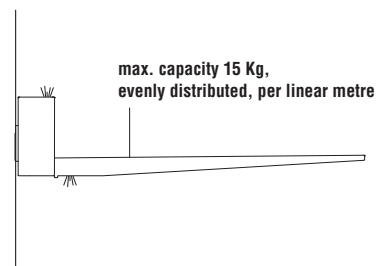
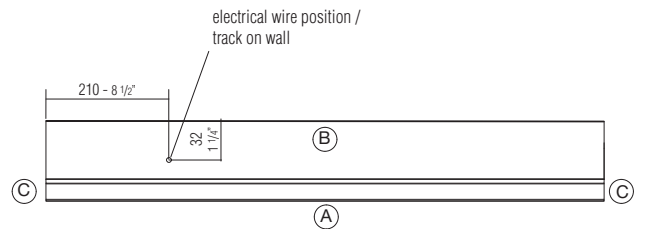

DATASHEET

REGISTERED
DESIGN

IX.2023

SHELVES WITH BACK

Shelves with back are available in 4 versions:

- 1 shelf H 308 12 1/8"
- 1 shelf H 616 24 1/4"
- 2 shelves H 616 24 1/4"
- 3 shelves H 924 36 3/8"

Wall fastening (with adjustments) takes place using special brackets hidden behind the back panels.

Plates must be anchored to the wall using state-of-the-art procedures on walls in masonry (solid wall or hollow brick).

The dealer is responsible for help in choosing the right tools to safely perform every type of operation and guarantee safety and capacity (**Kg 15 per linear metre, uniformly distributed**).

We recommend a very scrupulous evaluation of the structural conditions of the wall prior to ordering and mounting the product.

Molteni&C is not responsible for mounting procedures that do not comply with the instructions above.

Shelf finishes

pewter colour
iris

Back finishes

matt lacquer in Molteni range colours
glossy lacquer in Molteni range colours
wood

Shelves with back panel can be custom made in width (min. 950 / max. 2770), they cannot be reduced in depth and the height of the modules cannot be changed.

Each single shelf can be outfitted with a LED lighting bar.

The shelf/shelves block, in the various sizes, is always completed with a special top and side closing profile in the same finish as the shelves.

For the best installation result, we suggest providing electrical connections in the part behind the back panels as shown in the drawing below.

The top back panel is provided with a compartment that can house power supply units, connector, and remote control kit.

Molteni&C

12

16

side section

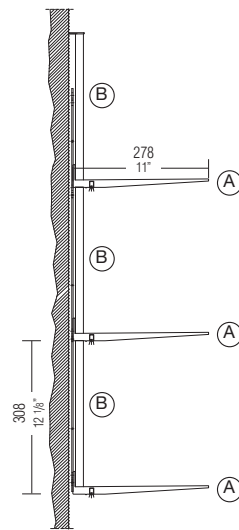

front view

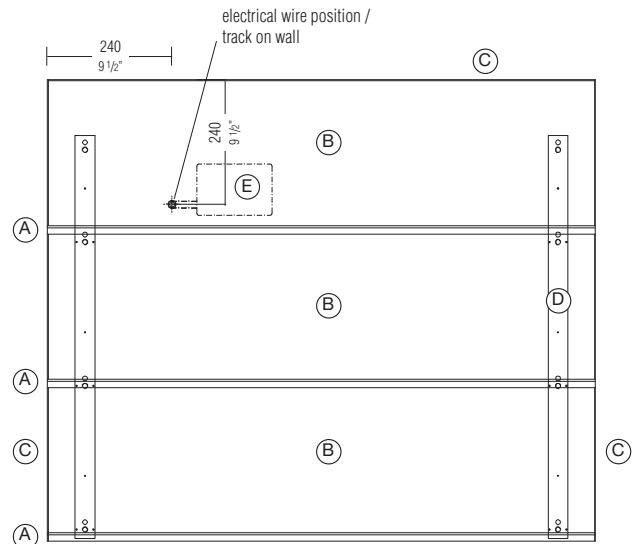

- (A) Shelf
- (B) Back panel
- (C) Side (dx-right, sx-left) and upper closing profile
- (D) Wall fastening bracket
- (E) Compartment containing electrical components

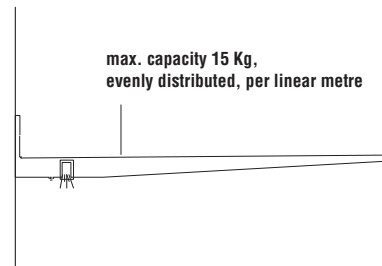

DATASHEET

REGISTERED
DESIGN

IX.2023

SUPPORT SHELVES

Support shelves are mounted on the wall with special plates. Plates must be anchored to the wall using state-of-the-art procedures on walls in masonry (solid wall or hollow brick). The dealer is responsible for help in choosing the right tools to safely perform every type of operation and guarantee safety and capacity (**Kg 30 per linear metre, uniformly distributed**).

We recommend a very scrupulous evaluation of the structural conditions of the wall prior to ordering and mounting the product.

Molteni&C is not responsible for mounting procedures that do not comply with the instructions above.

On request, a kit with chemical anchors is available, as indicated on the following page (minimum wall thickness 100 mm).

The support shelf is completed with a wall panel and, on the top, a rise with wire passage in predefined positions (see diagram).

The wire passage is included in the price and if a support shelf without wire passage is requested, no increase will be considered.

For sizes 2560 and 2770 mm, is it possible, on request, to provide multiple wire passages in the predefined positions, considering a surcharge each.

The rise can be fitted with an LED lighting bar, including power supply unit, to be connected to a controlled switch or to the (optional) remote control kit.

The lower part of the support shelf can receive conduit for electrical wires.

The conduit is mandatory in the presence of LED lighting bars and wire passages.

Molteni&C

13 –
16

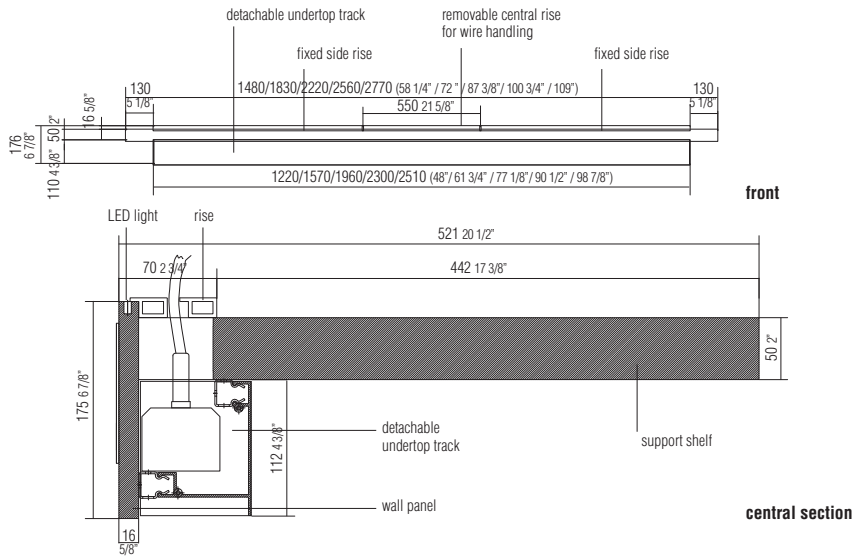

Wire passage position on the support shelf

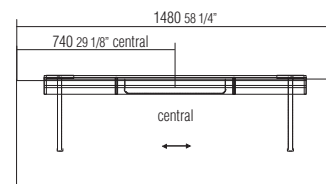
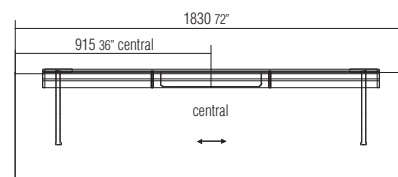
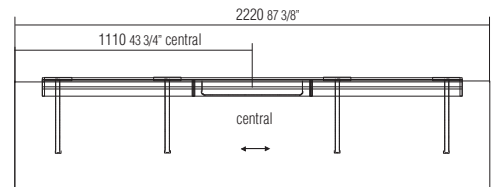
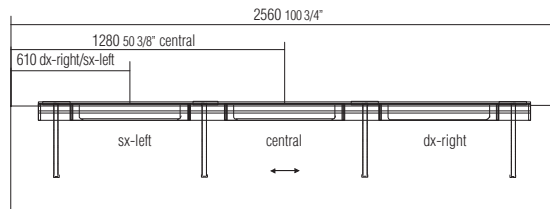
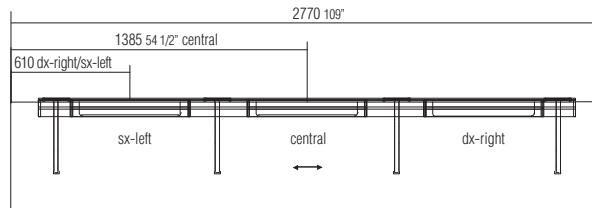

DATASHEET

REGISTERED
DESIGN

IX.2023

HORIZONTAL HANGING DISPLAY CABINET WITH FLAP DOOR AVAILABLE WITH DOWNWARD OR UPWARD FLAP DOOR

No reductions of any kind are possible.

Total load uniformly distributed kg 15.

Optional

The top of the cabinet may be fitted with LEDs (3000° K).
The back panel may be fitted with a mirror.

Wood / metal part finishes

matt lacquer pewter colour / pewter colour
matt lacquer iris / iris

Door and side glass finishes

transparent
transparent stopsol

Molteni & C

14
16

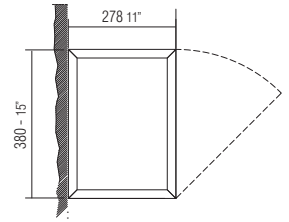
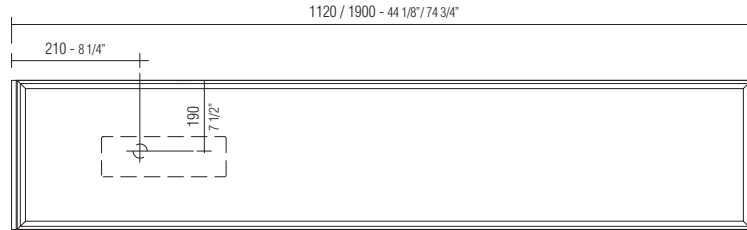

side view
downward flap door

The power cord must come out of the wall in correspondence with each wall mounted module and it must be prepared for use with a controlled socket or radio control kit.
Electrical connections must be carried out by qualified personnel.

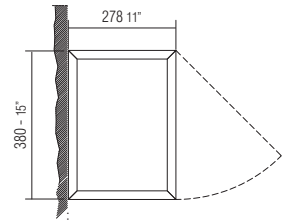

side view
upward flap door

Horizontal hanging display cabinet

W 1120 H 380 D 278
W 44 1/8" H 15" D 11"

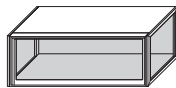

downward flap door
VT003/11 upward flap door
VTS03/11

W 1900 H 380 D 278
W 74 3/4" H 15" D 11"

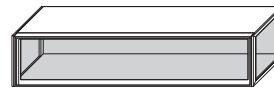

downward flap door
VT003/19 upward flap door
VTS03/19

radio control kit
with brightness setting
(optional)



EKRR1

DATASHEET

REGISTERED
DESIGN

IX.2023

VERTICAL HANGING DISPLAY CABINET WITH HINGED DOOR

The hanging display cabinet is always made with:
- pressure opening
- no. 3 internal shelves in transparent glass

Overall load capacity, evenly distributed on the internal shelves, Kg 8.

No reductions of any kind are possible.

**The cabinet shelves can be equipped with LED lighting (3000° K).
A single system for LED lighting on all shelves.**

Wood / metal part finishes
matt lacquer pewter colour / pewter colour
matt lacquer iris / iris

Door and side glass finishes
transparent
transparent stopsol

Molteni & C

15 —
16

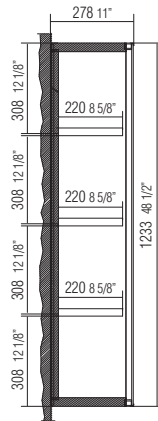

lateral section

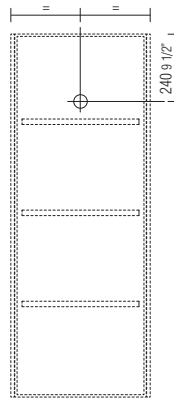

The power cord must come out of the wall in correspondence with each wall mounted module and it must be prepared for use with a remote controlled switch or a radio control kit. Electrical connections must be carried out by qualified personnel.

Vertical hanging display cabinet

W 470 18 1/2"
H 1233 48 1/2"
D 278 11"
opening only right

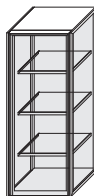

VTA05/12

**radio control kit
with brightness
setting
(optional)**



EKRR1

DATASHEET

REGISTERED
DESIGN

IX.2023

Pass-Word Evolution | Grid-Up Wall Unit

Notes

- No reductions of any kind or changes to the types are possible.
- The glass sides must only and always be used when a door is included.
- To make wall units with LED spotlights, consider: kit of 4 spotlights, power supply and, if there is no controlled socket, the radio control kit.
- LED light 3000K.

The grain of the wood back is always vertical.

Finishes of wood parts

- matt lacquer colours
- eucalyptus
- graphite oak
- sunrise oak
- coffee oak

Door finishes and glass side panels

- Glass:
- extra-clear transparent
 - stopsol transparent
- Profiles:
- pewter colour
 - iris

Molteni & C

Composition diagrams

Open

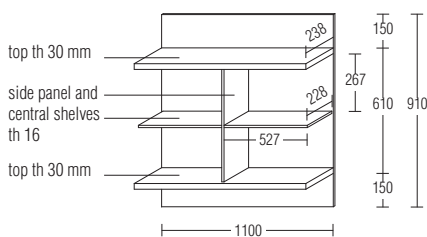

With 1 door (right-dx or left-sx)

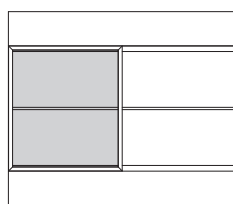

left-sx version

With 2 doors

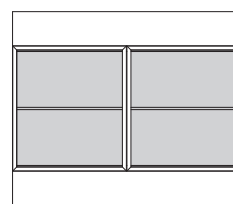

16 –
16

Grid-up wall unit D 262 H 910 W 1100

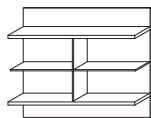

tops, side and central shelves
matt lacquered

tops, side and central shelves
in wood

GPS11/09

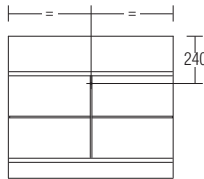

The power cord must come out of the wall in correspondence with each wall mounted module and it must be prepared for use with a controlled socket or radio control kit. Electrical connections must be carried out by qualified personnel.

glass door W 548 H 608 th 25



GABV05/60

glass side panel H 550 D 238 th 10



GSV2/60

kit of 4 spotlights directional leds 6,5 W

EFK04

power supply unit 60W

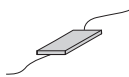

EAM1

radio control kit with brightness setting (1 per power supply unit) optional



EKRR1

connector for power supply units



ECO1

DATASHEET

REGISTERED
DESIGN

IX.2023

moltenigroup.com

Dimensions in millimeters and inches. The right to discontinue and make changes is reserved. This information is based on the latest product information available at the time of printing.