

# Molteni & C

## OCTAVE — VINCENT VAN DUYSSEN 2020

1—  
9



Octave is a system of modular sofas featuring rigorous shapes. A design marked by geometrical lines, based on mix & match modular elements that came together in linear, angular compositions or with the addition of hanging trapezoidal or rectangular elements in unusual and highly appealing configurations. Blade-like extruded steel legs support the base on which rest low rectangular fabric or leather upholstered backrests, of the same thickness as the cosy seat cushions. Guaranteeing the utmost comfort, complementary cushions, again rectangular or square, along with the headrest that can be freely positioned on the backrest, enabling it to be used in various positions. In addition to the traditional linear or corner elements, Octave offers open elements with which to create chaises longues or poufs that can be arranged alongside the composition or used as free-standing elements, also for the centre of the room. The conjoining rectangular or trapezoidal elements feature innovative hide leather trays on which to place all kinds of objects. Thanks to the possibility of creating articulated compositions, Octave is ideal in a “smart working” environment via the use of binding components designed to support laptops and tablets.



This symbol shows that the product has removable upholstery. Only qualified personnel can remove the upholstery of some of our products. If this information is pertinent, it will be included in the warnings section.



This symbol shows that the product is available on request in a fire resistant version that complies with the standards BS 5852 and TB 117-2013. The buyer is responsible for checking to make sure that the product is suitable and compliant with the requirements for the designated use and the current applicable laws and standards for the destination and use of the product.

DATASHEET

REGISTERED  
DESIGN

2026

[moltenigroup.com](http://moltenigroup.com)

Dimensions in centimeters and inches. The right to discontinue and make changes is reserved. This information is based on the latest product information available at the time of printing.

**FINISHES**

**BASE FINISHES**

painted zinc - painted pewter colour

**BONDED HIDE LEATHER FINISHES**

ivory - black - dark brown -  
natural - mud green - dove grey

**TECHNICAL INFORMATION**

**INTERNAL STRUCTURE**

Frame made of solid Firwood (Picea abies) and wood particle panels with elastic straps.

**STRUCTURE PADDING**

High performance variable density polyurethane foam. Cover in bonded velveteen.

**SEAT CUSHION**

Insert in shaped polyurethane and sterilized feathers. Cover in 100% cotton.

**BACKREST AND LOWER BACK SUPPORT CUSHIONS**

Polyester fibre and sterilised down. Cover in 100% cotton.

**HEADREST**

Polyurethane foam with high bearing capacity. Cover in bonded velveteen.

**TRINKET TRAYS**

Hot-welded steel sheet covered in bonded hide leather in colours from the Molteni range.

**FEET**

In painted hot-welded steel with non-slip plastic ferrules.

**REMOVABLE OUTER COVER**

(See enclosed sheet, specific for the cover in question).



AVAILABLE IN FIRE-RESISTANT  
VERSION TB117 AND BS5852

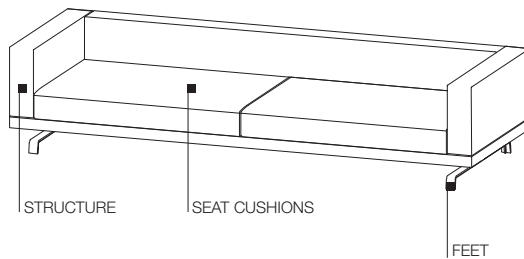

STRUCTURE

SEAT CUSHIONS

FEET

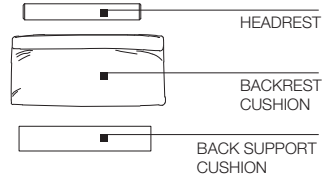

HEADREST

BACKREST  
CUSHION

BACK SUPPORT  
CUSHION

HEADREST



**CORNER SHELF**

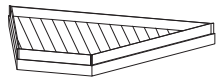

**TRINKET TRAYS**

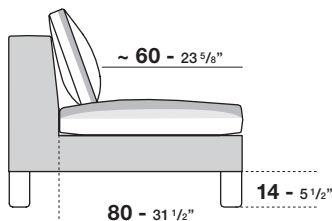
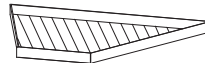
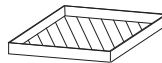

~ 60 - 23 5/8"

80 - 31 1/2"

14 - 5 1/2"

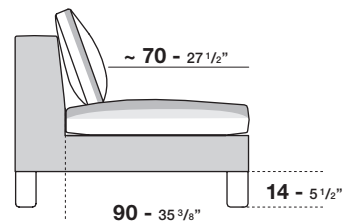

~ 70 - 27 1/2"

90 - 35 3/8"

14 - 5 1/2"

**DATASHEET**

REGISTERED  
DESIGN

2026

**DEPTH 95 cm - 37 3/8"**

Seat depth for structure only, 80 cm

Seat depth with backrest cushion, ~ 60 cm

Feet height 14 cm (from ground to under seat)

**DEPTH 105 cm - 41 3/8"**

Seat depth for structure only, 90 cm

Seat depth with backrest cushion, ~ 70 cm

Feet height 14 cm (from ground to under seat)

## NOTES

- ▶ List codes with **final A:**  
Depth 105 cm.
- ▶ List codes with **final C:**  
Depth 95 cm.
- ▶ **For correct ergonomics and maximum comfort, we recommend designing each module with a backrest cushion, headrest and lower back support cushion, in accordance with the pairings/measurements suggested in the price list. In addition to correct ergonomics, the presence of these elements makes the product look complete and elegant.**
- ▶ **ATTENTION:**  
The trinket trays cannot be ordered individually but only combined with the modules provided in the price list.
- ▶ **The corner shelf must always be used with one padded element on the right and another on the left.  
The corner shelf cannot be used as an end/final element.**

## When ordering

Specify the measurements of backrests, headrests and back support cushions.

# Molteni & C

3—  
9

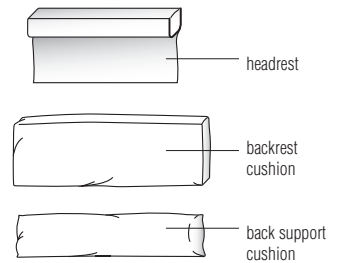
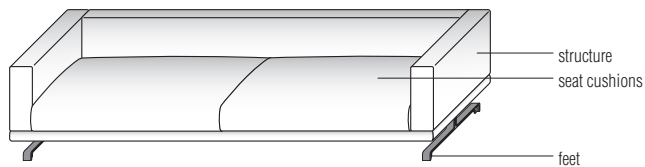

## Corner shelf

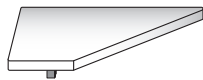

## Trinket trays

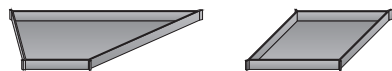

## DATASHEET

REGISTERED  
DESIGN

2026

**DIMENSIONS**

**Octave depth 95**

Molteni & C

4—  
9

**sofa**  
**DI270C**

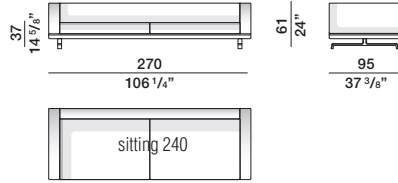

**back cushion**  
W 120 - 47 1/4"

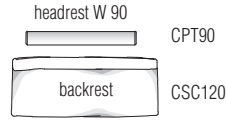

**back cushion**  
W 105 - 41 3/8"

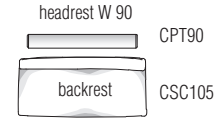

**ornamental cushion**  
**PCU90/75**

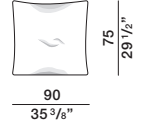

**sofa**  
**DI240C**

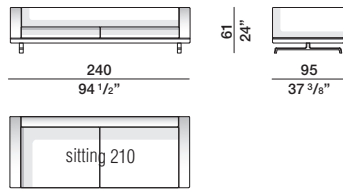

**back cushion**  
W 105 - 41 3/8"

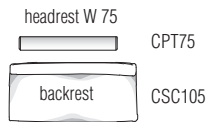

**back cushion**  
W 90 - 35 3/8"

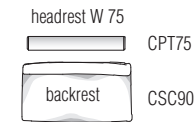

**ornamental cushion**  
**PCU90/75**

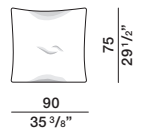

**sofa**  
**DI210C**

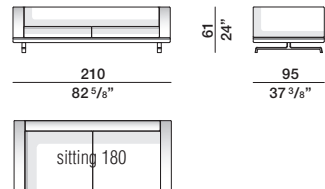

**back cushion**  
W 90 - 35 3/8"

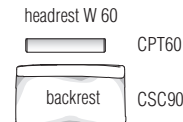

**back cushion**  
W 75 - 29 1/2"

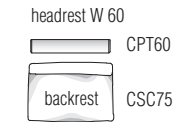

**ornamental cushion**  
**PCU90/75**

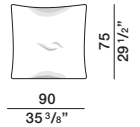

**DATASHEET**

REGISTERED  
DESIGN

2026

**DIMENSIONS**

**Octave depth 105**

Molteni & C

5—  
9

**sofa**  
**DI270A**

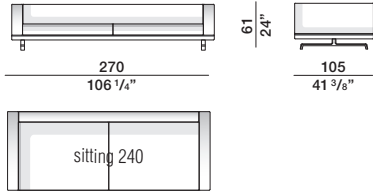

**back cushion**  
W 120 - 47 1/4"

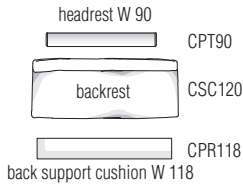

**back cushion**  
W 105 - 41 3/8"

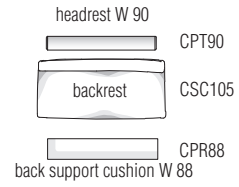

**ornamental cushion**  
**PCU90/75**

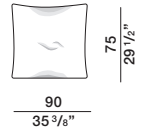

**sofa**  
**DI240A**

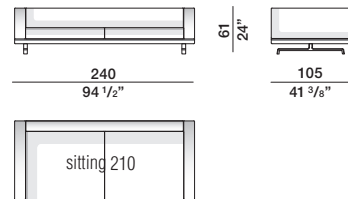

**back cushion**  
W 105 - 41 3/8"

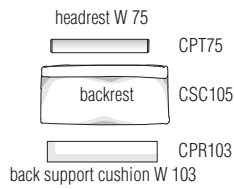

**back cushion**  
W 90 - 35 3/8"

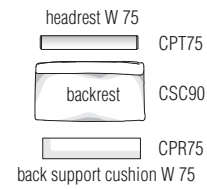

**ornamental cushion**  
**PCU90/75**

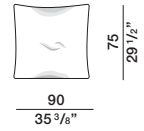

**sofa**  
**DI210A**

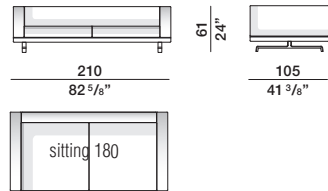

**back cushion**  
W 90 - 35 3/8"

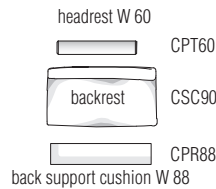

**back cushion**  
W 75 - 29 1/2"

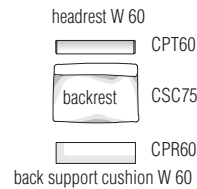

**ornamental cushion**  
**PCU90/75**

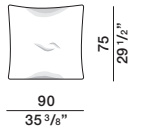

**end element**  
**TE255A dx - sx**

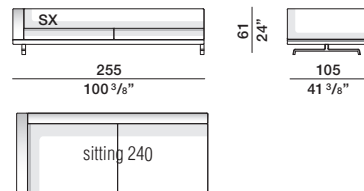

**back cushion**  
W 120 - 47 1/4"

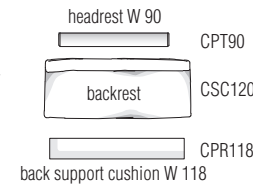

**back cushion**  
W 105 - 41 3/8"

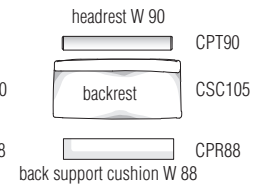

**ornamental cushion**  
**PCU90/75**

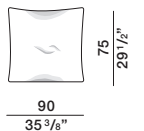

**end element**  
**TE225A dx - sx**

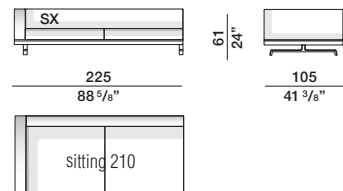

**back cushion**  
W 105 - 41 3/8"

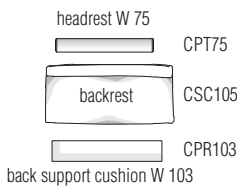

**back cushion**  
W 90 - 35 3/8"

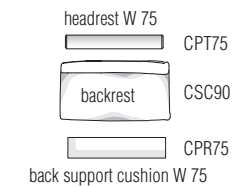

**ornamental cushion**  
**PCU90/75**

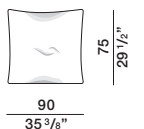

**DATASHEET**

REGISTERED  
DESIGN

2026

**DIMENSIONS**

**Octave depth 105**

**end element**  
TE195A dx - sx

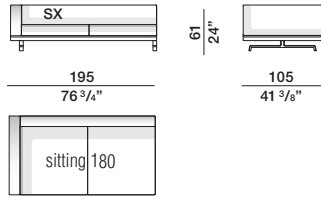

**back cushion**  
W 90 - 35 3/8"

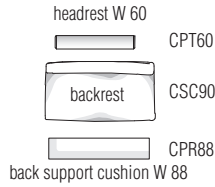

**back cushion**  
W 75 - 29 1/2"

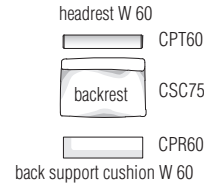

**ornamental cushion**  
PCU90/75

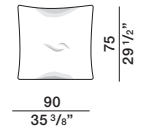

**end element**  
TE135A dx - sx

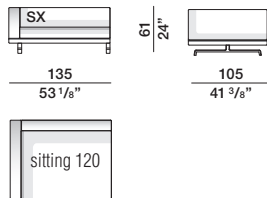

**back cushion**  
W 120 - 47 1/4"

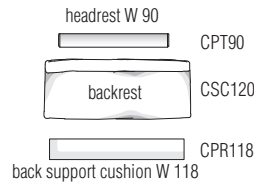

**back cushion**  
W 105 - 41 3/8"

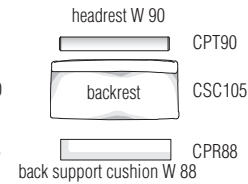

**ornamental cushion**  
PCU90/75

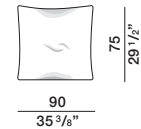

**end element with tray (60x90)**  
TV255A dx - sx

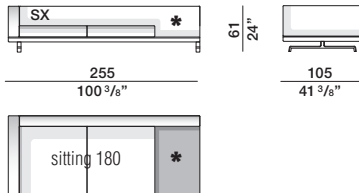

**back cushion**  
W 90 - 35 3/8"

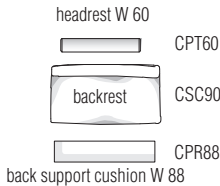

**back cushion**  
W 75 - 29 1/2"

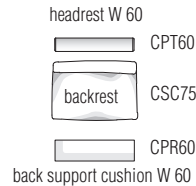

**ornamental cushion**  
PCU90/75

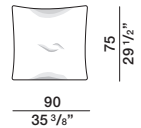

**end element with tray (60x90)**  
TV195A dx - sx

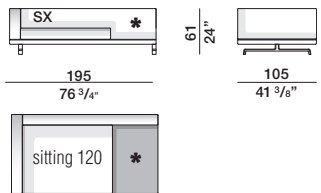

**back cushion**  
W 120 - 47 1/4"

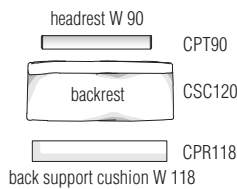

**back cushion**  
W 105 - 41 3/8"

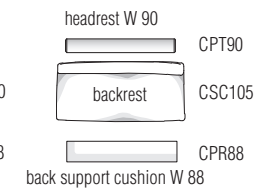

**ornamental cushion**  
PCU90/75

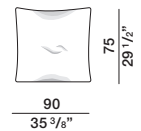

**central element**  
CT210A

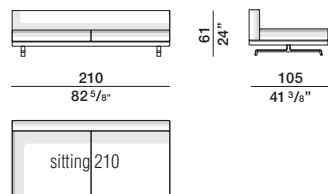

**back cushion**  
W 105 - 41 3/8"

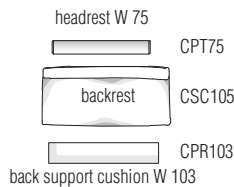

**back cushion**  
W 90 - 35 3/8"

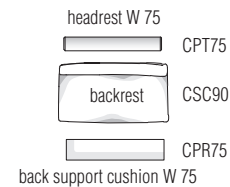

**ornamental cushion**  
PCU90/75

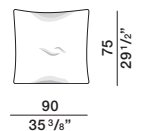

**DATASHEET**

REGISTERED  
DESIGN

2026

**DIMENSIONS**

**Octave depth 105**

**central element**  
CT180A

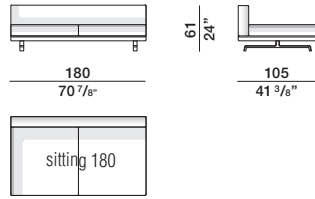

**back cushion**  
W 90 - 35 3/8"

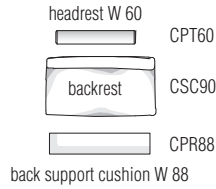

**back cushion**  
W 75 - 29 1/2"

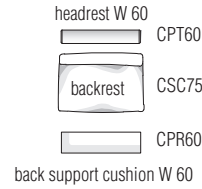

**ornamental cushion**  
PCU90/75

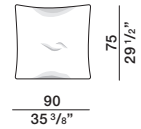

**central element**  
CT120A

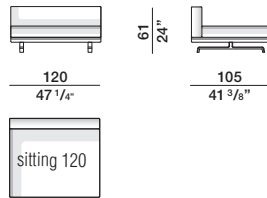

**back cushion**  
W 120 - 47 1/4"

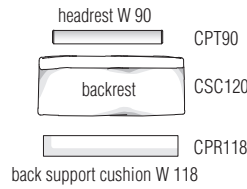

**back cushion**  
W 105 - 41 3/8"

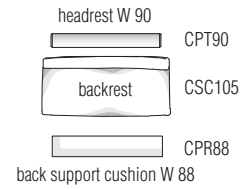

**ornamental cushion**  
PCU90/75

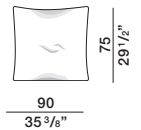

**island element**  
IS150A dx - sx

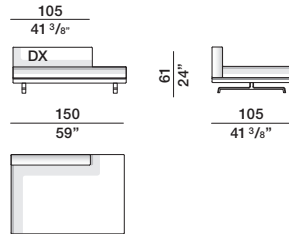

**back cushion**  
W 105 - 41 3/8"

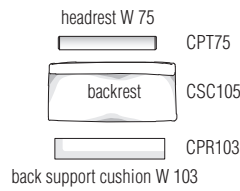

**back cushion**  
W 90 - 35 3/8"

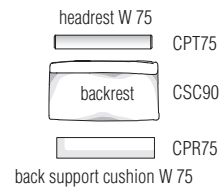

**ornamental cushion**  
PCU90/75

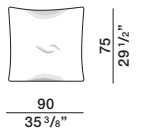

**island element with tray (60x90)**  
IV240A dx - sx

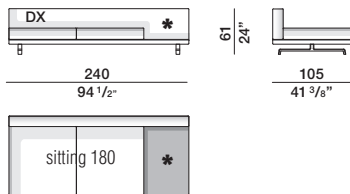

**back cushion**  
W 90 - 35 3/8"

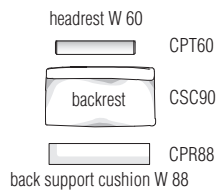

**back cushion**  
W 75 - 29 1/2"

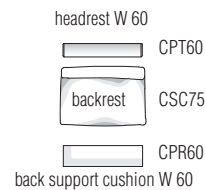

**ornamental cushion**  
PCU90/75

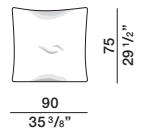

**island element with tray (60x90)**  
IV180A dx - sx

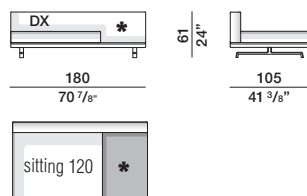

**back cushion**  
W 120 - 47 1/4"

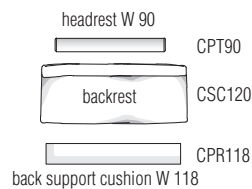

**back cushion**  
W 105 - 41 3/8"

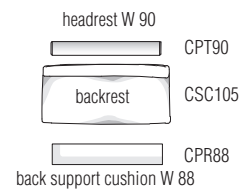

**ornamental cushion**  
PCU90/75

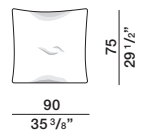

**DATASHEET**

REGISTERED  
DESIGN

2026

**DIMENSIONS**

**island element with tray (60x90)**  
IV150A dx - sx

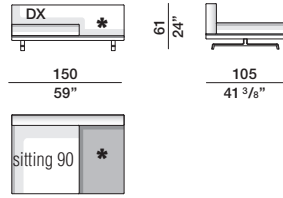

**chaise longue**  
CL105 dx - sx

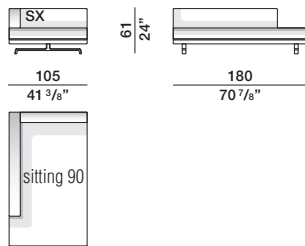

**daybed**  
DB105

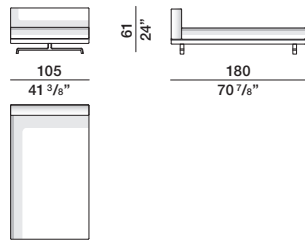

**corner island element**  
IA224A dx - sx

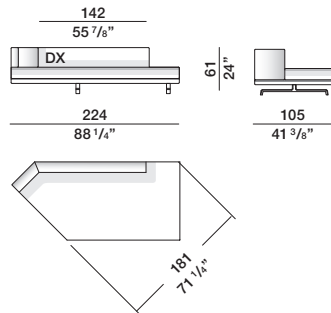

**pouf**  
PF105A

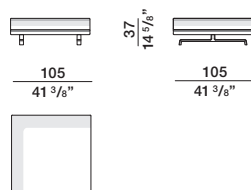

**back cushion**  
W 90 - 35 3/8"

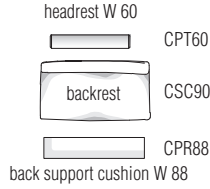

**back cushion**  
W 90 - 35 3/8"

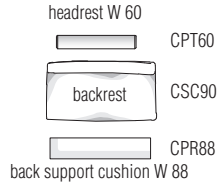

**back cushion**  
W 105 - 41 3/8"

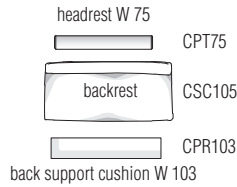

**back cushion**  
W 120 - 47 1/4"

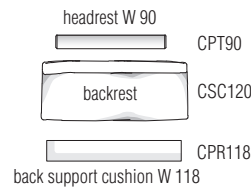

**back cushion**  
W 75 - 29 1/2"

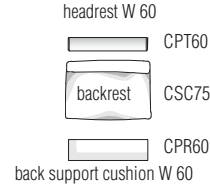

**back cushion**  
W 75 - 29 1/2"

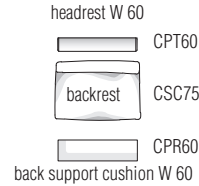

**back cushion**  
W 90 - 35 3/8"

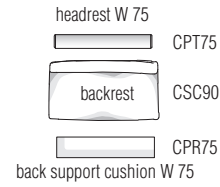

**back cushion**  
W 105 - 41 3/8"

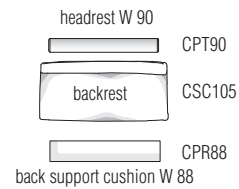

**ornamental cushion**  
PCU90/75

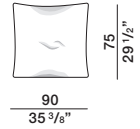

**ornamental cushion**  
PCU90/75

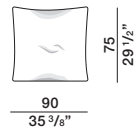

**ornamental cushion**  
PCU90/75

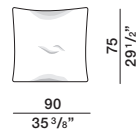



## DIMENSIONS

### corner shelf

#### AME2

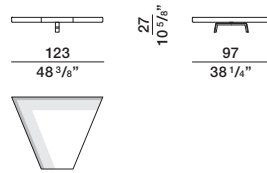

Molteni & C

### trinket tray

#### AVP1

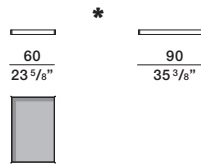

9—  
9

### trinket tray

#### AVP2

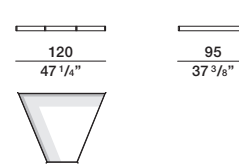

code	gross weight kg.	volume mc.	packages	code	gross weight kg.	volume mc.	packages
DI270C	139	2,3	1	CT210A	110	1,8	1
DI240C	130	2,1	1	CT180A	82,8	1,5	1
DI210C	120	2	1	CT120A	60	1,1	1
DI270A	139	2,3	1	IS150A	82	1,4	1
DI240A	130	2,1	1	IV240A	117	2	1
DI210A	120	2	1	IV180A	91	1,6	1
TE255A	145	2,3	1	IV150A	85	1,4	1
TE225A	127	2,15	1	CL105	96	1,59	1
TE195A	112	1,8	1	DB105	90	1,5	1
TE135A	88	1,4	1	IA224A	106	2	1
TV255A	130	2,22	1	PF105A	49	0,7	1
TV195A	109	1,85	1	AME2	29	0,38	1

## DATASHEET

REGISTERED  
DESIGN

2026